

**The Slovak Society for Operations Research
Department of Operations Research and Econometrics
Faculty of Economic Informatics
University of Economics in Bratislava**

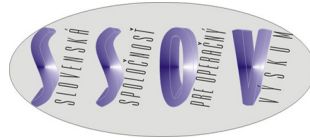

**Proceedings of the International Scientific Conference
QUANTITATIVE METHODS IN ECONOMICS
Multiple Criteria Decision Making XVII**

28th – 30th May 2014

Virt, Slovakia

Programme Committee:

Fendek Michal, University of Economics, Bratislava
Fiala Petr, University of Economics, Prague
Ivaničová Zlatica, University of Economics, Bratislava
Jablonský Josef, University of Economics, Prague
Lukáčik Martin, University of Economics, Bratislava
Mlynarovič Vladimír, Comenius University, Bratislava
Palúch Stanislav, University of Žilina, Žilina
Pekár Juraj, University of Economics, Bratislava
Turnovec František, Charles University, Prague
Vidović Milorad, University of Belgrade, Belgrade
Zouhar Jan, University of Economics, Prague

Organizing Committee:

Balažovičová Eva, University of Economics, Bratislava
Gežík Pavel, University of Economics, Bratislava
Reiff Marian, University of Economics, Bratislava
Surmanová Kvetoslava, University of Economics, Bratislava
Šedivý Marián, University of Economics, Bratislava

Referees:

Brezina Ivan, University of Economics, Bratislava
Čemická Katarína, University of Economics, Bratislava
Chocholátá Michaela, University of Economics, Bratislava
Čičková Zuzana, University of Economics, Bratislava
Fendek Michal, University of Economics, Bratislava
Fiala Petr, University of Economics, Prague
Furková Andrea, University of Economics, Bratislava
Gežík Pavel, University of Economics, Bratislava
Goga Marián, University of Economics, Bratislava
Hančlová Jana, VŠB-Technical University, Ostrava
Horniaček Milan, Comenius University, Bratislava
Ivaničová Zlatica, University of Economics, Bratislava
Jablonský Josef, University of Economics, Prague
Janáček Jaroslav, University of Žilina, Žilina
König Brian, University of Economics, Bratislava
Kuncová Martina, University of Economics, Prague
Lukáčiková Adriana, University of Economics, Bratislava
Lukáčik Martin, University of Economics, Bratislava
Michalski Grzegorz, Wrocław University of Economics, Wrocław
Pekár Juraj, University of Economics, Bratislava
Peško Štefan, University of Žilina, Žilina
Reiff Marian, University of Economics, Bratislava
Rublíková Eva, University of Economics, Bratislava
Surmanová Kvetoslava, University of Economics, Bratislava
Szomolányi Karol, University of zbtEconomics, Bratislava

28th – 30th May 2014

Virt, Slovakia

Technical Editor: Reiff Marian, Pavel Gežík, University of Economics, Bratislava

Web Editor: Lukáčik Martin, University of Economics, Bratislava

Web: <http://www.fhi.sk/en/katedry-fakulty/kove/ssov/papers//>

Publisher: Vydavateľstvo EKONÓM

ISBN 978-80-225-3868-8

Number of copies: 80

CONTENT

Borovička Adam	<u>McCahone's Approach and its Modifications for a Comparison of the Fuzzy Numbers</u>	7
Brezina Jr. Ivan Gežík Pavel Mieresová Lucia	<u>Pricing in Supply Chain and Simulation of Return</u>	14
Černá Anna Černý Jan Palúch Stanislav Peško Štefan Příbyl Vladimír	<u>Note to Economically Optimal Road Subnetwork</u>	20
Černá Anna Černý Jan Volek Josef	<u>Heuristic and Exact Methods for the Location of Ambulance Stations</u>	26
Černý Michal	<u>Interval Data and Regression Models: some Notes, Applications and Problems</u>	31
Fendek Michal	<u>Price Differentiation of a Monopoly Production – Microeconomic Analysis</u>	36
Ferreira Manuel Alberto M.	<u>The Pandemic Period Length Modelled Through $M G \infty$ Queue Systems</u>	43
Fiala Petr	<u>Modeling Framework for Dynamic Pricing and Resource Allocation in Networks</u>	48
Furková Andrea	<u>Are Slovak Economic Faculties Efficient in their Scientific Activities? DEA Approach</u>	53
Horniaček Milan	<u>Inventory Management in Cournot Duopoly</u>	58
Horvát Peter König Brian Ostrihoň Filip	<u>Estimation of Slovak Fiscal Policy Model Using Bayesian Approach</u>	62
Horvát Peter	<u>Exploring Factors of Workers Allocation into Occupation in Slovakia</u>	71
Hozlár Eduard	<u>Factoring Credit Risk and its Security Modeling</u>	79
Chocholatá Michaela	<u>Relationship between Conditional Correlation and Conditional Volatility: Evidence from Selected Central and Eastern European Markets</u>	82
Ivaničová Zlatica Ostrihoň Filip	<u>Consumption Smoothing and Risk Sharing Across the Regions (Fiscal Effects Panel Data Approach)</u>	88
Jablonský Josef	<u>Comparison of Ranking Methods in Two-Stage Serial DEA Models</u>	97
Janáček Jaroslav Kvet Marek	<u>Disutility Relevance Model and Effectiveness of Algorithm for the Weighted P-Median Problem</u>	103
Janáčková Marta Szendreyová Alžbeta	<u>Rounding the Values in the Distance Matrix and the Effect on the Solving the P-Median Problem</u>	111
Jánošíková Ludmila Žarnay Michal	<u>Location of Emergency Stations as the Capacitated P-Median Problem</u>	116

König Brian Domonkos Tomáš	<u>Estimation of Indirect Costs of Unemployment (Cross Country Comparison – SR and CZ)</u>	123
Kučera Petr Bartoška Jan Šubrt Tomáš	<u>Mathematical Models of the Student Syndrome for Use in Project Management</u>	128
Kuncová Martina Sekničková Jana	<u>Multi-Criteria Analysis and Simulation Applied on the Czech Electricity Market</u>	134
Kupkovič Patrik Benkovič Martin	<u>Closed form Solution for Simple Small Open Economy</u>	139
Kvet Marek Janáček Jaroslav	<u>Impact of Population Distribution on the Optimal Public Service System Design</u>	146
Majer Tomáš Palúch Stanislav	<u>Several Attitudes to a Fair Double Rate on a Bus Line</u>	155
Marek Luboš Vrabec Michal	<u>Mixture of Johnson Distribution</u>	162
Matulová Markéta	<u>Consistency of Additive Preference Matrix in Pairwise Comparisons</u>	171
Michalski Grzegorz	<u>Effective Working Capital Investment - German Firms Case</u>	176
Mlynarovič Vladimír	<u>The Analytical System for Portfolio Performance and Risk Distribution</u>	182
Němec Daniel	<u>Efficiency of the Matching Process on the Czech Regional Labour Markets</u>	188
Pastoreková Silvia	<u>ARIMA with Intervention Analysis to Model and Forecast Export of Goods and Services of Slovak Republic</u>	196
Pekár Juraj Brezina Ivan Čičková Zuzana	<u>Synchronization of Vehicle Routing Problem in Two Periods</u>	201
Peško Štefan	<u>Capacitated P-Median Problem on Sparse Networks</u>	207
Pisca Vratislav Vašíček Osvald	<u>Behavior of Slovak Economy Integrated into EMU: DSGE Model with a Government Sector and Inflation Targeting</u>	213
Příbyl Vladimír Černá Anna Černý Jan Nonato Maddalena	<u>Partial Service Routes with Multiple Visits to Edges</u>	220
Rosenberg Zdeněk	<u>Minimalistic Simulation of Population Aging's Implications in the Slovak Republic</u>	226
Rublíková Eva	<u>Modeling Trends and Cycles of GDP in Slovakia</u>	231
Schulz Jaroslav Mikula Štěpán	<u>Impact of Minimum Wage Dynamics on Unemployment: an Empirical Approach</u>	236

Skocdopolova Veronika	<u>University Timetabling: some Special Constraints</u>	245
Stolín Radek	<u>Policyholder's Risk in Czech and Slovak Bonus-Malus Systems</u>	249
Surmanová Kvetoslava Reiff Marian	<u>Okun's Law Verification at the Slovak Regions Data</u>	255
Szomolányi Karol Lukáčik Martin Lukáčiková Adriana	<u>Slovak Economy and Interest Rates Shocks</u>	263
Ševčík Vítězslav Klapka Jindřich	<u>Mathematical Method for Multicriterial Project Selection</u>	269
Šimková Eubica	<u>An Example of Renegotiation-Proof Equilibrium with Product Innovation</u>	276
Teichmann Dusan Dorda Michal Ivan Martin	<u>Multi-Criteria Optimization of Distribution System Structure – Comparison of Selected Methods and their Effectiveness</u>	280
Tichá Michaela	<u>Noncooperative Multicriteria Games</u>	287
Tvrz Stanislav Vašíček Osvald	<u>Nonlinear DSGE Model of Slovak Economy with Time-Varying Parameters</u>	292
Zouhar Jan	<u>Discrete Strategy Spaces and PQ Oligopoly Equilibria</u>	298

MCCAHONE'S APPROACH AND ITS MODIFICATIONS FOR A COMPARISON OF THE FUZZY NUMBERS

*Adam Borovička,
University of Economics Prague*

Abstract

The article deals with the McCahone's approach. It is an algorithm for a comparison of the (triangular) fuzzy numbers. The method uses the concept of the fuzzy minimum and fuzzy maximum. The shares of the fuzzy numbers in the fuzzy ideals are calculated, and then some indices are formulated in order to compare the fuzzy numbers. The principle of the algorithm is described in detail. The comparison with other methods is also included. But McCahone's approach can fail because it sometimes ignores the location of the fuzzy numbers on the horizontal axis. To improve this shortcoming, the additional procedures and modifications are proposed in this text. All mentioned cases are illustrated in some simple examples.

Keywords: comparison, fuzzy number, McCahone's approach

JEL Classification: C44, C61

AMS Classification: 90-08

1 INTRODUCTION

We have many methods for a comparison of the fuzzy numbers. One of them is McCahone's approach. The principle of this algorithm is based on the specification of the fuzzy ideals – fuzzy maximum and fuzzy minimum. It is described in the second chapter in more detail. The comparison with other methods is also included.

The introduced algorithm has one mistake. It can sometimes ignore the location of the fuzzy numbers on the horizontal axis in the graphical representation. Then the results can be against human intuition. The problematic cases are described and additional procedure or improvement of this algorithm are proposed or recommended. These describes cases are illustrated in some examples in order to understand them better.

2 MCCAHONE'S APPROACH

McCahone's approach is included to the group of methods which use the proportion to the ideal for a ranking of the fuzzy numbers (McCahone, 1987). The fuzzy ideals are specified as the fuzzy maximum (max) and the fuzzy minimum (min). The ranking is determined by measuring how much the proportional area of a fuzzy number contributes to the fuzzy ideals. The higher percentage a fuzzy number contributes to the fuzzy max, the higher it is ranked, and the higher percentage a fuzzy number contributes to the fuzzy min, the lower it is ranked.

2.1 Comparison with other approaches

We know many methods that were proposed several decades ago, but they are still applied in terms of various decision making approaches. Some methods are based on the index of optimality, or the degree of preference of one fuzzy set against another one. In terms of this group of methods, we can see the approach using the conditional membership function and also α -level (Baas and Kwakernaak, 1977). This method is computationally very difficult. Other methods are based on the Hamming distance concept, for instance (Yager, 1980; Kerre, 1982; Nakamura, 1986; Kolodziejczyk, 1986). This concept has one shortcoming. In some cases, it ignores a relative location of the fuzzy numbers on the horizontal axis in a graphical

representation, so the results can be against human intuition. Furthermore, many approaches apply the concept of α -level to compare the fuzzy numbers. I think that these methods have one big problem, namely the determination of level α . This value is usually demanded from a decision maker which does not have to be easy for him/her. Moreover, the determination of one value of α causes biased results. The Mabuchi approach tries to eliminate this shortcoming by the determination of several α -levels (Mabuchi, 1988). Other methods use the mean of fuzzy numbers, the range of their values as well, for example the method of Lee and Lie (Lee and Li, 1988). The more detailed classification and some principles of the methods can be seen in publication (Chen and Hwang, 1992). Of course, we have many other approaches proposed in recent times. These methods are mostly based on the calculation of some indices according to which the fuzzy numbers are compared. In terms of this group of methods, the following concepts should be mentioned which use the minimizing and maximizing membership function (Wang and Luo, 2009; Raj and Kumar, 1999). To compare the trapezoidal or triangular fuzzy numbers, it is possible to employ the distance among them (Tran and Duckstein, 2002). In my opinion, a calculation of the distance is unnecessary for their comparison. The information about the distance is additional and the specification and calculation can be very difficult. Other methods compute the areas among the membership functions to compare the fuzzy numbers (Fortemps and Roubens, 1996). Another approach defines the preference function, or preference coefficient (Modarres and Sadi-Nezhad, 2001). This approach is not user-friendly for computational complexity. In (Chu and Tsao, 2002), the proposed method compares the fuzzy numbers by calculating the area between the centroid of the fuzzy number and the origin of the coordinate system. This approach favours the location on the vertical axis against the horizontal axis. This shortcoming is weakened by the modification (Wang and Lee, 2008). To summarize many approaches for fuzzy number comparison based on the various coefficient and indices, the publication (Wang and Kerre, 2001) is recommended.

And why did I just choose McCahone's approach for a comparison of the fuzzy numbers? The algorithm is user-friendly, it is comprehensible for users, decision makers. It is not computationally difficult. Maybe the principle could become more complicated for more than several tens of fuzzy numbers, but it is not a big problem for the latest computer technology. The computational complexity and incomprehension are a shortcoming of many methods mentioned above. I prefer the approaches with no additional input information from the site of a decision maker as it is mentioned above. McCahone's approach satisfies this condition. Another criterion for an option method is a type of the fuzzy number. Most methods work with triangular or trapezoidal fuzzy numbers. My concept includes triangular fuzzy numbers, so some approaches are not usable for my inspiration. For instance, (Abbasbandy and Hajjari, 2009) uses only trapezoidal fuzzy numbers.

2.2 Algorithm

Let us describe the whole algorithm of McCahone's approach. Given n fuzzy numbers F_1, F_2, \dots, F_n . The fuzzy max, or the membership function of fuzzy max can be formulated as

$$\mu_{\max}(x) = \sup_{x=x_1 \vee x_2 \vee \dots \vee x_n} [\mu_{F_1}(x_1) \wedge \mu_{F_2}(x_2) \wedge \dots \wedge \mu_{F_n}(x_n)] \quad \forall x, x_1, x_2, \dots, x_n, \quad (1)$$

where $\mu_{F_1}(x_1), \mu_{F_2}(x_2), \dots, \mu_{F_n}(x_n)$ are the membership functions of fuzzy numbers F_1, F_2, \dots, F_n .

We can analogously specify fuzzy min as

$$\mu_{\min}(x) = \sup_{x=x_1 \wedge x_2 \wedge \dots \wedge x_n} [\mu_{F_1}(x_1) \wedge \mu_{F_2}(x_2) \wedge \dots \wedge \mu_{F_n}(x_n)] \quad \forall x, x_1, x_2, \dots, x_n. \quad (2)$$

The fuzzy max and fuzzy min can be illustrated as follows (Figure 1).

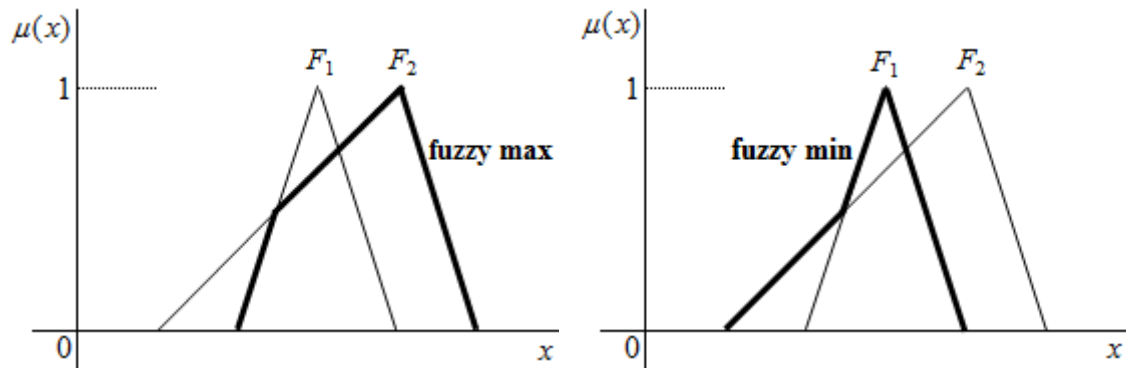

Figure 1: Fuzzy max and fuzzy min (Chen and Hwang, 1992)

Now we compute the contribution of the fuzzy number F_i ($i = 1, 2, \dots, n$) toward the fuzzy max by the following formula

$$P(F_i) = \frac{\int_{S(F_i)} [\mu_{\max}(x) \wedge \mu_{F_i}(x)] dx}{\int_{S(F_i)} \mu_{F_i}(x) dx}, \quad (3)$$

where $S(F_i)$ is the definition scope of the i -th fuzzy number F_i .

Similarly, the contribution of the fuzzy number F_i ($i = 1, 2, \dots, n$) toward the fuzzy min is defined by

$$N(F_i) = \frac{\int_{S(F_i)} [\mu_{\min}(x) \wedge \mu_{F_i}(x)] dx}{\int_{S(F_i)} \mu_{F_i}(x) dx}. \quad (4)$$

The contribution of the fuzzy number F_i toward fuzzy max, or fuzzy min is displayed by the following graph (Figure 2).

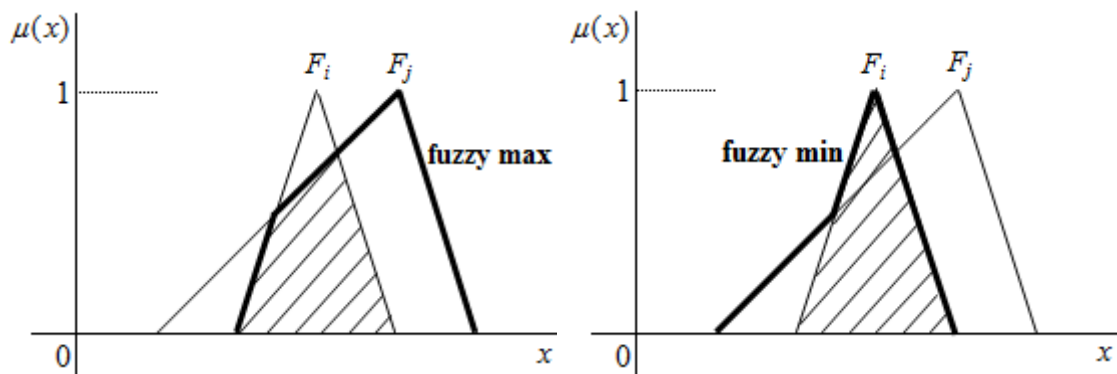

Figure 2: Contribution of F_i toward the fuzzy max and fuzzy min (Chen and Hwang, 1992)

In the next step, we rank the fuzzy numbers according to $P(F_i)$ descending and $N(F_i)$ upwardly. Two rankings are compared. If both ranking orders are identical, the algorithm stops. If not, we will pick the fuzzy numbers sharing the same positions and perform pairwise comparison via the rules described in the following section.

We calculate the composite index

$$CP(F_i) = \frac{P(F_i)}{P(F_i) + N(F_i)}. \quad (5)$$

And now all fuzzy numbers sharing the same position are ranked descending according to this indicator. If the index is identical for more fuzzy numbers, it is not possible to distinguish them. Then we use the second rule; thus, we compare the absolute sum of $P(F_i)$ and $N(F_i)$. One of the following relations must hold

$$\begin{aligned}
 &\text{if } P(F_k) + N(F_k) > P(F_l) + N(F_l), \text{ then } F_k > F_l, \\
 &\text{if } P(F_k) + N(F_k) < P(F_l) + N(F_l), \text{ then } F_k < F_l, \\
 &\text{if } P(F_k) + N(F_k) = P(F_l) + N(F_l), \text{ then } F_k = F_l.
 \end{aligned} \tag{6}$$

And now a full ranking of the fuzzy numbers is available.

3 PROBLEMS WITH MCCAHONE’S APPROACH

The problem of the described method is that the locations of the fuzzy numbers are not sometimes considered. If all fuzzy numbers share in at least one fuzzy ideal, the approach gives representative results. But now let us introduce several problematic cases when some fuzzy numbers do not share in any fuzzy ideals.

3.1 Case 1

Define n fuzzy numbers $\tilde{F}_1, \tilde{F}_2, \dots, \tilde{F}_n$, where \tilde{F}_1 is the fuzzy min and \tilde{F}_n fuzzy max. Both extremes do not overlap other fuzzy numbers. The situation is depicted in the following graph (Figure 3).

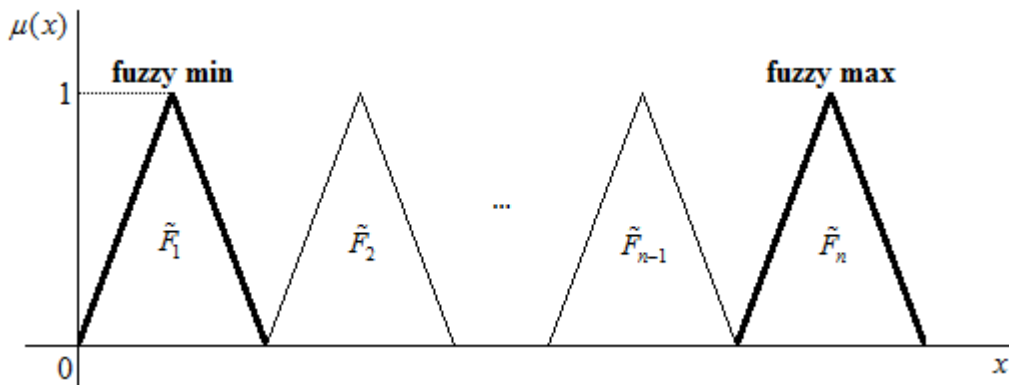

Figure 3: Indiscrimination of McCahone’s approach

In this ominous situation, it holds $P(F_2) = \dots = P(F_{n-1}) = N(F_2) = \dots = N(F_{n-1}) = 0$. Of course, \tilde{F}_1 is the lowest (the last) and \tilde{F}_n the greatest (the first). The fuzzy numbers $\tilde{F}_2, \tilde{F}_2, \dots, \tilde{F}_{n-1}$ will share the same position according to this algorithm and it is not possible to differentiate them by formulae (5), or (6), even if they can be unambiguously different. It is possible to apply McCahone’s approach once again only for these fuzzy numbers to rank them in terms of the common positions and then make a full ranking of all fuzzy numbers.

Imagine more specific situation (Figure 4).

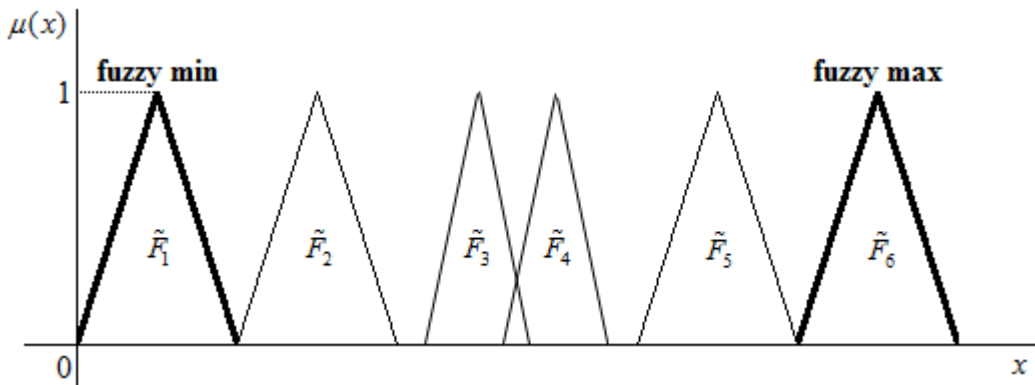

Figure 4: Triple application of McCahone's approach

The position of \tilde{F}_1 and \tilde{F}_6 is clear. The ranking of other fuzzy numbers cannot be specified satisfactorily. To rank these fuzzy numbers, the algorithm will be applied once again. But \tilde{F}_3 and \tilde{F}_4 cannot be distinguished for the same reason mentioned above. To compare these two fuzzy numbers, McCahone's approach will be applied once again. And then a full ranking of all fuzzy numbers is available.

It is obvious that this process of comparison can be quite long. In special case (e. g. in Figure 4), McCahone's approach must not be applied several times. Specify the triangular fuzzy numbers \tilde{F}_i ($i = 2, 3, \dots, n-1$) formally as

$$(a_i, b_i, c_i) \quad i = 2, 3, \dots, n-1, \tag{7}$$

where a_i, b_i, c_i ($i = 2, 3, \dots, n-1$) is lower, peak and upper point of the i -th triangular fuzzy number. If it holds for each couple of the fuzzy numbers

$$a_i R a_j, b_i R b_j, c_i R c_j \quad i, j = 2, 3, \dots, n-1, i \neq j, \tag{8}$$

where R is the same relation mark, then the fuzzy numbers \tilde{F}_i ($i = 2, 3, \dots, n-1$) are ranked according to (a_i, b_i, c_i) ($i = 2, 3, \dots, n-1$) descending.

3.2 Case 2

As in the previous situation, the fuzzy numbers not sharing in the fuzzy ideals do not intersect the fuzzy numbers that they share in the fuzzy ideals. The second case can be graphically described as follows (Figure 5).

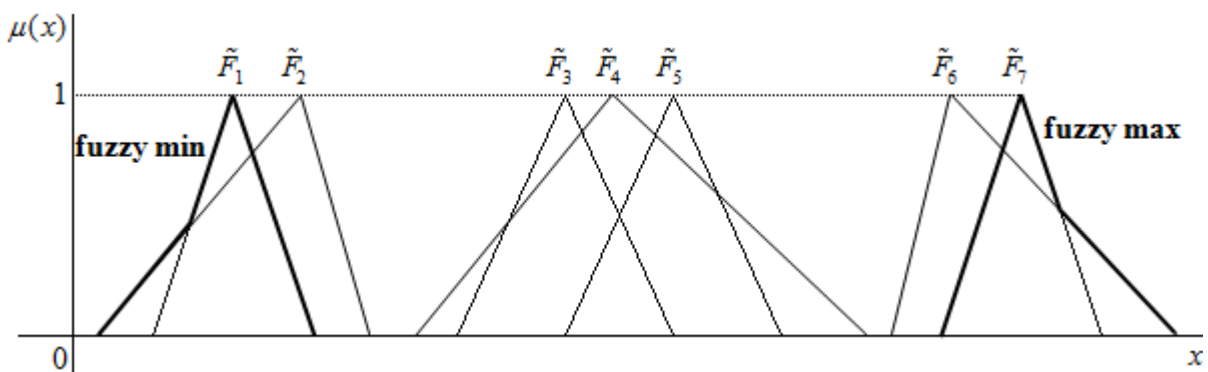

Figure 5: Case 2

The procedure of a ranking is similar as in the previous case. To compare really the fuzzy numbers \tilde{F}_3 , \tilde{F}_4 and \tilde{F}_5 , McCahone's approach will be applied once again or in the special case the additional procedure mentioned above (8) will be employed.

3.3 Case 3

The third case has one important difference compared to both previous situations. The fuzzy numbers, whose contribution to fuzzy ideals is zero, intersect some other fuzzy numbers sharing in the fuzzy ideals. This situation is depicted in the following graph (Figure 6).

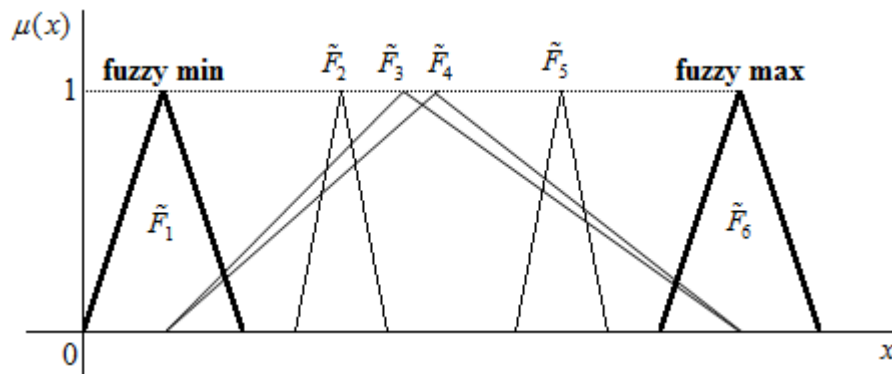

Figure 6: Case 3

As we can see, the fuzzy numbers \tilde{F}_3 and \tilde{F}_4 are almost the same. But \tilde{F}_3 evaluated as lower and \tilde{F}_4 as greater than the fuzzy numbers \tilde{F}_2 and \tilde{F}_5 . It is obvious that McCahone's approach fails. In this case, the application of other approach is recommended.

4 CONCLUSION

The article deals with McCahone's approach which is the method for a comparison of the fuzzy numbers. The whole algorithm is closely described and is compared with other methods.

I realize that a comparison of the vague values, or the fuzzy numbers, is not easy. The result is based on the used algorithm. I think that just the approach using the fuzzy extremes is suitable for a comparison of the fuzzy numbers. It is logical and factual. The idea of share in fuzzy max and fuzzy min is correct. Of course, the algorithm has one important shortcoming, because sometimes the results are evidently against human intuition. So it is not possible to use for all cases. To eliminate the biased results, the algorithm is rightly modified or the usage of other approach is recommended. All problematic cases are obviously illustrated.

Acknowledgements: The research project was supported by Grant No. IGA F4/19/2013 of the Internal Grant Agency, Faculty of Informatics and Statistics, University of Economics, Prague and Grant No. 13-07350S of the Grant Agency of the Czech Republic.

References

- [1] Abbasbandy, S. and Hajjari, T. (2009) 'A new approach for ranking of trapezoidal fuzzy number', *Computers and Mathematics with Applications*, vol. 3, pp. 413–419.
- [2] Bass, S. M. and Kwakernaak, H. (1977) 'Rating and ranking of multiple aspect alternative using fuzzy sets', *Automatica*, vol. 13, pp. 47–58.
- [3] Chen, S. J. and Hwang, C. L. (1992) *Fuzzy Multiple Attribute Decision Making: Methods and Applications*, Berlin: Springer-Verlag.
- [4] Chu, T. C. and Tsao, C. T. (2002) 'Ranking fuzzy numbers with an area between the centroid point and the original point', *Computers and Mathematics with Applications*, vol. 43, pp. 111–117.

- [5] Fortemps, P. and Roubens, M. (1996) 'Ranking and defuzzification method based on area compensation', *Fuzzy Sets and Systems*, vol. 82, pp. 319–330.
- [6] Kerre, E. E. (1982) 'The use of fuzzy set theory in electrocardiological diagnostics', in Gupta, M. M. and Sanchez, E. (ed.) *Approximate Reasoning in Decision Analysis*, Amsterdam: North-Holland, pp. 277–282.
- [7] Kolodziejczyk, W. (1986) 'Orlovsky's concept of decision-making with fuzzy preference relation-further results', *Fuzzy Sets and Systems*, vol. 19, pp. 11–20.
- [8] Lee, E. S. and Li, R. L. (1988) 'Comparison of fuzzy numbers based on the probability measure of fuzzy events', *Computer and Mathematics with Applications*, vol. 15, pp. 887–896.
- [9] Mabuchi, S. (1988) 'An approach to the comparison of fuzzy subsets with α -cut dependent index', *IEEE Trans on Systems, Man, and Cybernetics*, vol. 18, pp. 264–272.
- [10] McCahone, C. (1987) *Fuzzy Set Theory Applied to Production and Inventory Control*, Dissertation, Kansas State University.
- [11] Modarres, M. and Sadi-Nezhad, S. (2001) 'Ranking fuzzy numbers by preference ratio', *Fuzzy Sets and Systems*, vol. 118, pp. 429–436.
- [12] Nakamura, K. (1986) 'Preference relation on a set of fuzzy utilities as a basis for decision making', *Fuzzy Sets and Systems*, vol. 20, pp. 147–162.
- [13] Raj, P. A. and Kumar, D. N. (1999) 'Ranking alternatives with fuzzy weights using maximizing set and minimizing set', *Fuzzy Sets and Systems*, vol. 105, pp. 365–375.
- [14] Tran, L. and Duckstein, L. (2002) 'Comparison of fuzzy numbers using a fuzzy distance measure', *Fuzzy Sets and Systems*, vol. 130, pp. 331–341.
- [15] Wang, Y. J. and Lee, H. S. (2008) 'The revised method of ranking fuzzy numbers with an area between the centroid and original point', *Computers and Mathematics with Applications*, vol. 55, pp. 2033–2042.
- [16] Wang, Y. M. and Luo, Y. (2009) 'Area ranking of fuzzy numbers based on positive and negative ideal points', *Computers and Mathematics with Applications*, vol. 58, pp. 1767–1779.
- [17] Wang, X. and Kerre, E. E. (2001) 'Reasonable properties for the ordering of fuzzy quantities (I) and (II)', *Fuzzy Sets and Systems*, vol. 188, pp. 387–405.
- [18] Yager, R. R. (1980) 'On choosing between fuzzy subsets', *Kybernetes*, vol. 9, pp. 151–154.

Author's address

Ing. Adam Borovička

University of Economics in Prague, Faculty of Informatics and Statistics, Department of Econometrics

W. Churchill Sq. 4, 130 67 Prague 3

Czech Republic

E-mail: adam.borovicka@vse.cz

PRICING IN SUPPLY CHAIN AND SIMULATION OF RETURN

*Ivan Brezina Jr., Pavel Gežík, Lucia Mieresová,
University of Economics in Bratislava*

Abstract

New trends in production, limited natural resources and environmental waste problems affect the transformation of classical supply chain. This transformation consists of using reverse logistics to ensure the return of end-of-life products back to producer. The applications of the various back rebates, cash-back from returned products and discounts have a positive impact on the pricing of the product in a competitive environment. There are a lot of uncertainties in estimating the quantity of returned products and therefore to determine this quantity of returned products. That is a reason for using simulations of return to estimate the quantity and define pricing policy by simulation results.

Keywords: *Pricing Policy, Return, Rebates, Simulation, Collections points*

JEL Classification: C60, C63

AMS Classification: 90B10, 90C08, 90C90

1 INTRODUCTION

The first step for pricing in supply chain is to clearly understand how the producer chooses to compete. This is important not only for the obvious reason to make a profit but also for the reason that it forces the supply chain operation to see itself as a consumer which is purchasing materials. One way of saving cost of purchasing materials is recycling or reusing end-of-life products. That is a reason why producers have to motivate consumers of their products to return this product back to producer or to point of collection of these end-of-life products.

One of these kinds of motivation can be also pricing policy which includes rebates and discounts. The producers also have to prepare new supply chains with reverse flow because they need to get returned products from the places of their final consumption. By *Guide, Wassenhove, 2009* there are many kinds of return: natural return – recovery pairs, consumers return – repair, end-of-use return – remanufacture and end-of-life return – recycling.

2 PRICING IN SUPPLY CHAIN WITH RETURN

There are many different actors/entities in classic supply chain like suppliers, producers (manufactures), distributors, retailers and consumers but basic supply chain has three typical entities: *Producers (manufactures)* - at the beginning of the supply chain, *Distributors* - to serve to bridge the distance from producers to consumers, *Costumer* - end of supply chain.

Classical meaning of the supply chain is the typical forward logistics when producers are trying to sell goods to customer through distributors with the same goal to get the goods to the places of their market for sale at the lowest possible cost. This classic supply chain can be illustrated by following *Figure 1* when goods are going from the left side to the right side (*Brezina, Pekár, Reiff, 2013*)

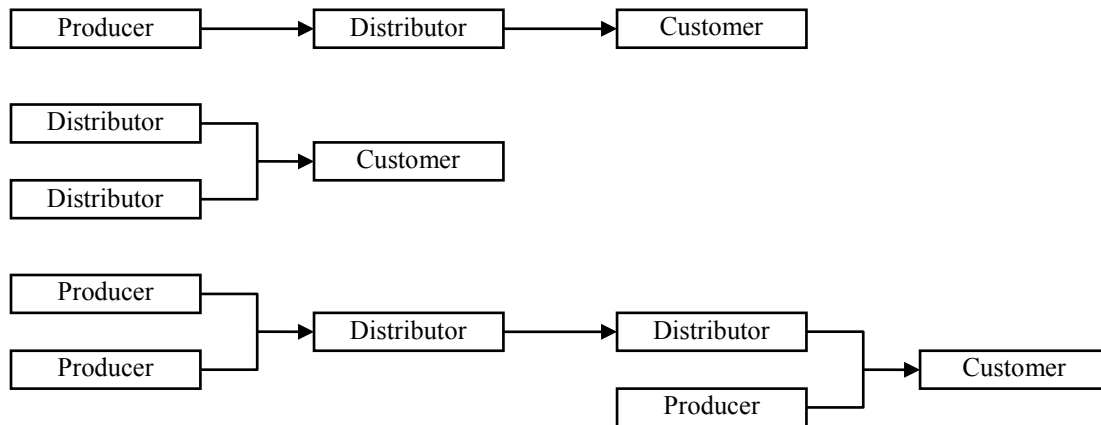

Figure 1 - Serial, parallel and combined supply chain

In this supply chain is pricing policy set by the producers and then it is affected by other actors/entities in the supply chain and by their shipping cost. The pricing policy of those actors/entities can be made *separately* - each entity has its own pricing policy or *together* - pricing policy is set by the producer (principal distributor) for final consumers with respect to other subject in the supply chain.

New trends in production, limited natural resources and environmental waste problems affect the transformation of classical supply chain. This transformation consists of using reverse logistics to ensure the return of end-of-life products back to producer. This return can be used for recycling, remanufacturing and reuse of materials. With these processes can producers reduce their costs of production or costs of purchase of materials and set pricing policy which is affected by previous saving of costs. Then there is a place for the application of the various rebates and discounts that have a positive impact on the pricing of the product in a competitive environment.

Return of product or reverse logistics can be operated or managing by new actors/entities for supply chain. That can be point of collection, recycling point or point of reuse where consumers can return their end-of-life product for a reason rebates or discount for next purchase or for cash-back. These back rebates and discounts may represent a strong factor that affects the pricing policy.

The supply chain with these new entities typical for reverse logics can be illustrated in *Figure 2*. There are previous entities which are in *Figure 1* and added new entities – collection point. Between consumers and point of collection is reverse flow (dotted) which is representing return of product.

Pricing policy can be modeled by many principles and algorithms. Most of these principles and algorithms are based on deterministic pricing on the basis of production costs of products. But if pricing policy should include discounts or rebates from return of products, it should be determined in the other way, concretely stochastic way. There are a lot of uncertainties in estimating the quantity of returned products and therefore to determine this quantity of returned products. That is a reason for using simulations of return to estimate the quantity and define pricing policy by simulation results. Simulations are optimization methods that generate and use random variables for solving stochastic problems. They can be used for estimate real situation with known stochastic entry.

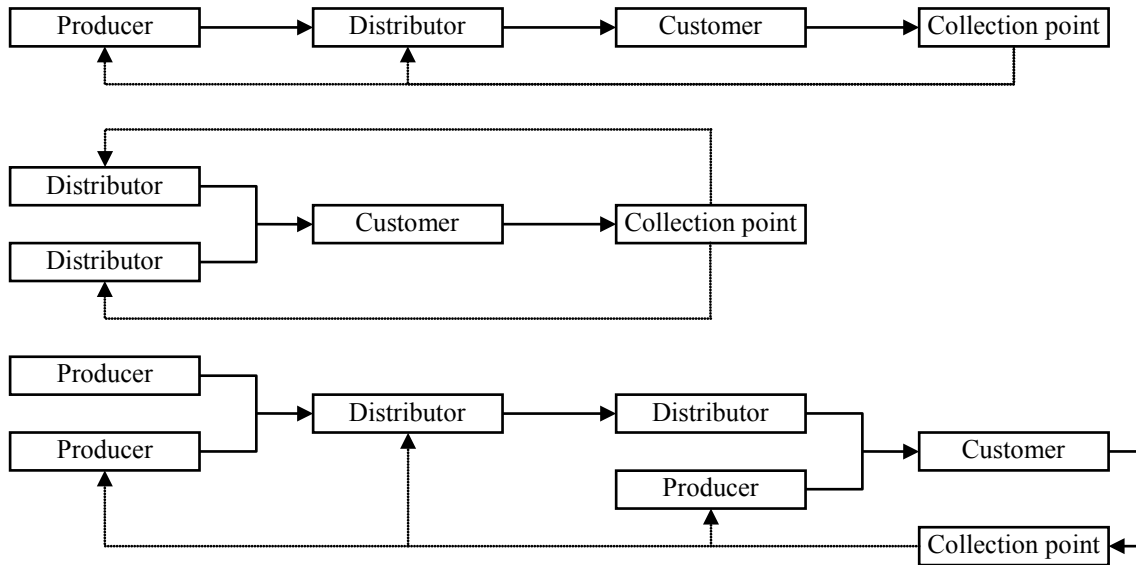

Figure 2 - Serial, parallel and combined supply chain with reverse flow

3 SIMULATION OF QUANTITY OF RETURNED PRODUCTS

An illustrative example of simulation of product return can be solving problem of location and operation collection point in Bratislava region with 87 municipalities. This example is based on real data and takes into account the character of the municipalities, resp. collection point in relation to the waste collected recyclables.

At the first is necessary solve the location problem for this region because is not possible to set up collection point in every municipalities. (Brezina, Čičková, Pekár, 2009). The aim of the model is to locate collection points so that it complied with required availability (in this case 10 minutes) of all nodes in a minimum of aggregators. The basis of the model of “*problem the location of the minimum number of collection points at the maximum distance the established threshold distance of each city/town from the collection center.*”

The problem can be formulated in many ways ei. (Reiff, 2008) and (Brezina, Hollá, Reiff, 2012). In this article was chosen model on the basis of the objective of minimizing the number of collection points as the bivalent programming with the variables $x_j \in \{0,1\}, j = 1, 2, \dots, n$, where n is the number of nodes. If the variable takes the value of 1 the collection point will be set up in the node and if the value is 0 the collection point will be not set up.

Constraints have to ensure that for each node the condition that the distance from the nearest collection point is the maximum K (10 minutes). Parameters d_{ij} are values of the distances between nodes i and j from matrix D (size $n \times n$) of the minimum distances between all nodes. On the basis of the above matrix D can construct matrix A (size $n \times n$) whose elements a_{ij} acquire a value of 0 if the distance between i -th and j -th node is bigger than K or 1 if the distance is less than or equal to K . The availability of at least one collection point for the maximum distance can

be ensuring by constraints $\sum_{j=1}^n a_{ij} x_j \geq 1, i = 1, 2, \dots, n$.

Based on the above mathematical formulation is $f(x) = \sum_{j=1}^n x_j \rightarrow \min$ with constraints

$$\sum_{j=1}^n a_{ij} x_j \geq 1 \text{ for } i = 1, 2, \dots, n \text{ and condition } x_j \in \{0,1\} \text{ for } j = 1, 2, \dots, n \text{ where } a_{ij} = \begin{cases} 0, & d_{ij} > K \\ 1, & d_{ij} \leq K \end{cases} \text{ for}$$

$i, j = 1, 2, \dots, n.$

a_{ij} – availability of i -th node of the j -th node to the distance K ,

K – maximum possible distance.

The solution of this mathematical formulation for presented example was finding 26 points of collection in Bratislava region from 87 municipalities. (*Mieresová, 2013*)

Next part of example is solving routing problem of collection points in the chosen municipalities. This problem is called Traveler Salesman Problem (TSP). The traveling salesman problem is one of the best known NP-hard problems, what means, that there is no exact algorithm to solve it in polynomial time. The minimal expected time to obtain optimal solution is exponential. So for that reason, we usually use heuristics to help us to obtain a “good” solution. The most known exacts methods for solving TSP are: *explicit enumeration, implicit enumeration, branch and bound method, cutting plane method and dynamic programming*. These methods work well only for solving the problems with no more as 40-80 nodes (we suppose the use of one computer). In the formulation of TSP we consider with only one salesman, respectively with only one vehicle. It is expected that the capacity of the vehicle is huge enough to meet the requirements of all nodes. The aim is to identify those roads of vehicles, which ensure the operation of all nodes (collection points), while the total length of the circular road completed by individual vehicles was minimal.

Graph $\bar{G} = \{U, \bar{H}\}$ is completely edge weighted graph in which every two distinct nodes are connected by an edge. Then the matrix $D = \{d_{ij}\}$ represents the shortest distance nodes. Its elements can be defined as follows:

$$d_{ij} = \begin{cases} d_{ij}, & \text{ak } i \neq j \\ 0, & \text{ak } i = j \end{cases}$$

TSP can be mathematically formulated in several ways. Below is said known Trucker’s formulation of this task.

$$\min f(x) = \sum_{i=1}^n \sum_{j=1}^n d_{ij} x_{ij} \quad (1)$$

$$\sum_{i=1}^n x_{ij} = 1, \quad j = 1, 2, \dots, n \quad i \neq j \quad (2)$$

$$\sum_{j=1}^n x_{ij} = 1, \quad i = 1, 2, \dots, n \quad i \neq j \quad (3)$$

$$y_i - y_j + n x_{ij} \leq n - 1, \quad i, j = 2, 3, \dots, n \quad i \neq j \quad (4)$$

$$x_{ij} \in \{0,1\}, \quad i, j = 1, 2, \dots, n \quad (5)$$

Resulting route starts in Senec and it is Senec - Kostolná pri Dunaji - Chorvátsky Grob - Tomášov - Dunajská Lužná - Bratislava Nové mesto - Bratislava Petržalka - Bratislava Dúbravka - Bratislava Devín - Stupava - Zohor - Vysoká pri Morave - Jakubov - Kostolište - Veľké Leváre - Malacky - Studienka - Sološnica - Pernek - Modra - Dubová - Budmerice - Báhoň - Blatné - Senec.

The main part of this example is about simulation of products return which is necessary to estimate the quantity and define pricing policy. In simulation municipalities were divided according to the character into 3 groups, considering size and population. The first group called "Bratislava" includes all suburban municipalities of Bratislava, the second group called "4_cities" includes Stupava, Pezinok and Senec, the last third group called "Others" includes the remaining 18 municipalities.

This division is necessary, since the model is based on the assumption that the residents of larger town, resp. capital city transmit more of recyclable waste. This assumption is justified by the current situation and habits of individual residents or the possibility of using recycled waste by residents in small communities.

The model is based on the simulation created in program Simul8. There are three inputs that represent three groups ("Bratislava", "4_cities" and "Others") in the model. From these inputs come entities into individual collection points, where are waiting for being "served", that is until comes the collecting vehicle.

Capacity of collecting vehicle or quantity of collected waste represents a container which collection vehicle is emptying at the end of the simulation in the last workplace.

The inputs are represented by settings of how entities are entering the system, that means, how the waste will be collected in individual collection point. This is shown in the setting of the distribution function, which was named "Base" in such a way that we have three time-dependent functions "Base_BA", "Base_4_cities" and "Base_others". Each of these functions will consists of two other functions. First function for the first eight hours of the simulation (functions "Base_BA", "Base4_cities", "Base_others"). And the second function "TSP" for the remaining time of the simulation.

Distribution function for input is given the name "Base" and is a time-dependent function that consists of two other functions and for the first eight hours of simulation functions "Collecting" and features "TSP" for the remainder of the simulation. All times are based on the conceptual design, where the collection point opening hours are 8:00 to 16:00, ie eight hours.

In functions "Collecting_BA", "Collecting_4_cities" and "Collecting_others" are set lower and upper limits. These limits are saying with what intensity the entity come into the system, ie with what intensity is waste collected, reflect the assumptions of the model by higher production estimate in the "Bratislava".

The "TSP" is firmly specified function, which ensures the fact that out of working hours of collection point no entity comes into this collection point. Therefore, the waste is not collected and collection point for residents is closed.

Types of Entities for individual collection points based on the data model, namely the population of each municipality, and based on the percentage assigned to each entity workplaces, ie collection point for the village in the catchment area. Inhabitants in the catchment areas, which assigns 87 municipalities of Bratislava region has 26 collection points.

The model is based on the population of each municipality and on the basis of the percentage assigned entity to each workplace. This percentage reflects the population of that group. In the "Bratislava" entities are assigned according to percentage of the population of the catchment area of the group for the 4 proposed collection points. This fact also applies to the allocation of entities in the group "4_cities" and in the group "Others".

4 CONCLUSION

In general the return of products can affect pricing policy. As can be seen, it is difficult to define the return in the real world but can be estimated by simulation. In cities with a bigger concentration of people is return of recyclable product more frequent and it has bigger influence on pricing policy. Then producers, distributors, etc. set lower prices for customers what has positive effect for company in competitive environment and also for customers.

Acknowledgements: This work was supported by the Grant Agency of Slovak Republic – VEGA, grant no. 1/0104/12 „Modeling supply chain pricing policy in a competitive environment“.

References

- [1] Brezina, I., Hollá, A. and Reiff, M. (2012) 'Stochastic inventory location model', *Quantitative Methods in Economics: Multiple Criteria Decision Making XVI – Conference Proceedings*, The Slovak Society for Operations Research Conference, Bratislava, pp. 19-21.
- [2] Brezina, I., Pekár, J. and Čičková, Z. (2009) 'Model of the collection centers in communes of Slovak Republic', *Mathematical Methods in Economics 2009 – Conference Proceedings*, The Czech Society for Operations Research Conference, Prague, pp. 29-32.
- [3] Brezina, I., Pekár, J. and Čičková, Z. (2006) 'Storage location problem', *Quantitative Methods in Economics: Multiple Criteria Decision Making XIII – Conference Proceedings*, The Slovak Society for Operations Research Conference, Bratislava, pp. 5-10.
- [4] Brezina, I., Pekár, J., Reiff, M. (2013) 'The steady state price analysis of two stage supply chain', *1st Logistics International Conference Logic 2013 – Conference Proceedings*, University of Belgrade Conference, Belgrade, pp. 289-292.
- [5] Guide, R. D. and Van Wassenhove, N. L. (2009) 'The Evolution of Closed-Loop Supply Chain Research', *Operations Research*, vol. 57, no. 1, pp. 10-18.
- [6] Mieresová, L. (2013) 'Optimálna lokalizácia zberných miest v Bratislavskom kraji pri stanovenej maximálnej vzdialenosti', *Nové trendy v ekonometrii a operačným výzkumu – Conference Proceedings*, The Seminar of Department of Econometrics in Prague and Department of Operations Research and Econometrics in Bratislava, Prague, pp. 122-131.
- [7] Reiff, M. (2008) 'Supply chain modeling via robust optimization', *Quantitative Methods in Economics: Multiple Criteria Decision Making XIV – Conference Proceedings*, The Slovak Society for Operations Research Conference, High Tatras, pp. 254-260.

Author's address

Ing. Ivan Brezina Jr.

University of Economics in Bratislava, Faculty of business informatics, Department of Operations research and Econometrics,
Dolnozemska 1/b, 852 35 Bratislava, Slovak Republic
Email: brezina.ivan@yahoo.com

Ing. Pavel Gežík, PhD.

University of Economics in Bratislava, Faculty of business informatics, Department of Operations research and Econometrics,
Dolnozemska 1/b, 852 35 Bratislava, Slovak Republic
Email: pavelgezik@gmail.com

Ing. Lucia Mieresová

University of Economics in Bratislava, Faculty of business informatics, Department of Operations research and Econometrics,
Dolnozemska 1/b, 852 35 Bratislava, Slovak Republic
Email: lucia.mieresova@gmail.com

NOTE TO ECONOMICALLY OPTIMAL ROAD SUBNETWORK

Anna Černá,¹ Jan Černý,¹ Stanislav Palúch,² Štefan Peško,² Vladimír Příbyl¹
University of Economics in Prague¹
University of Žilina²

Abstract

The paper deals with the following problem: Given a road network represented by a non-oriented graph. Each edge has its length represented by a positive number. Given a set of important pairs of vertices, given a limit of the length of connecting path for each important pair, the problem is to find a subnetwork of minimum length meeting the constraint of limited connecting path for each important pair of vertices.

The paper presents heuristics and exact methods of solution and compares them on real and artificial (= randomly generated) networks.

Keywords: Optimization, economical, road, subnetwork, linear programming

JEL Classification: D85

AMS Classification: 05C35, 90C35

1 MOTIVATION AND FORMULATION OF THE PROBLEM

The paper is motivated by the following situation: A transportation network, e.g. the road, rarely the railway one, is served by a transport system. The quality of the network is not satisfactory but the improvement of the whole network is not possible for the economic reasons. Responsible managers make decisions how to choose a smaller subnetwork suitable for meeting certain quality constraint and minimizing costs. The constraint is formulated by means of a set W of significant pairs of nodes and by numbers $q_w \geq 1$ for each $w = (u, v) \in W$ representing the maximal acceptable increase of length of route between the pair w .

Such a problem can appear e.g. in rural road network winter maintenance (when a part of the network had to remain untreated), choice of tram or trolleybus network as a subnetwork of the bus one etc.

2 RELATED PROBLEMS IN BIBLIOGRAPHY

The managerial decision problem from the previous part belongs to the network design problems (NDP's) solved often by heuristics, e.g. [25, 26]. The transport NDP [31] is formulated as follows: Given a network and a demand for transport on it. The problem is how to uprate current edges or to add new edges minimizing the total travel costs of all demanding elements. A NDP is called discrete [17] if it consists in an edge addition to a current network. A NDP is called continuous [22, 23] if it focuses on the improvement of current edges. A specific case of public transport is studied in [17]. Miandoabchi et al. [24] present the bus&car urban NDP of a complex type: lane addition to the current streets, new street addition, change some two-way streets to one-way ones, lane allocation for two-way streets, and the change of some street lanes to exclusive bus lanes are the measures for maximization of both consumer surplus, and the demand share of the bus mode as well.

A typical feature of modern transport networks is their growth [30]. Nevertheless, it brings both positive and negative effects. E. g., [18] draw attention to the increase trip length and travel time in the area of Madrid. However, Kelly and Niedzielski [21] show measures against this negative development.

The abovementioned topics represent the ‘main stream’ in NDP theory. However, that doesn’t work in weak demand areas as in remote regions. There, one can observe the opposite – the need to find a subnetwork of the existing network, briefly NDP-R (Network Design Problem - Reduction). However, it may evoke network vulnerabilities, as shown by E. Jenelius [20].

Papers, dealing directly with NDP-R are rare. One of them is the paper by Drezner and Wesolowsky [12]. It starts from a possible, but not yet existing, network. The problem is to choose a subnetwork to be constructed in the way minimizing the total costs of construction and transportation. However the problem the current paper deals with is different:

Assume that a transportation network covers an area meeting optimally the transport demand. Unfortunately, it is too expensive to operate the complete network and it is necessary to choose the cheapest subnetwork sufficiently fulfilling the original purpose. This condition is formulated by the set W of significant pairs of nodes and by the number $q \geq 1$ meaning the maximal acceptable increase of length of routes between nodes from the set W .

In the graph theory, many problems dealing with construction of maximal or minimal subgraphs having the given properties have been studied for decades. The first known algorithm finding the shortest spanning tree appeared in 1926 [2]. Further progress of spanning tree theory is presented by Cai and Corneil [4].

Many problems start with the given graph $G = (V, E, c)$ where $c(e) \geq 0$ is a “length”, “weight” or “cost” of the edge $e \in E$ and their targets are e.g.: to find the maximum planar subgraph [13], to find a λ -edge connected spanning subgraph with the minimum sum of edge weights for the given integer $\lambda > 0$ [9, 16], moreover, [14] where $c(e) \equiv 1$ and [5] with $\lambda = 2$.

Other authors try to find a k -vertex subgraph with the maximum sum of edge weights given integer $k > 0$ [28] or to find a k -vertex λ -edge connected subgraph with the minimum sum of edge weights given integers $k > 0, \lambda > 0$ [10, 27].

For the given integer $d > 0$, finding a subgraph with vertex degree not exceeding d and with the maximum sum of edge weights is dealt in [1] and ibidem, to the contrary, finding a subgraph with vertex degree not less than d with the minimum sum of edge weights.

Quite different problem can be found in [29], they start with a given graph G and its subgraph H . The problem is to find the minimum weight-sum subgraph isomorphic to H .

Hintsanen [19] takes $c(e)$ as the probability of break of service and the tries to eliminate k edges in order to the connection reliability maximization.

Ferrer et al. [15] study a finite set of graphs G_1, \dots, G_n and try to find the maximum common subgraph.

Berger and Shor, [3] look for the maximum acyclic subgraph of an given digraph.

Černá et al. [7] study the problem of finding spanning subgraph of a graph with prescribed distances between important pairs of vertices. It is proved in [11] that also q -relaxation of this problem is NP-hard problem, for any positive real number q .

The current paper can be considered a continuation of [6], where the formulation of the problem is presented and the way of the solution is outlined, and of [8] where one heuristics and two one phase exact methods are described in details. In the current paper a two phase exact method is proposed and it is shown that it is much faster than the previous one phase exact methods and not much slower than the heuristics.

3 THE 1ST STAGE OF TWO STAGE METHOD

Let $G = (V, E, d)$ be a connected undirected finite graph without loops with the length $d(e)$ for each $e \in E$. Let $r = v_0, e_1, v_1, e_2, v_2, \dots, v_{n-1}, e_n, v_n$ be a route on G and $d(r) = d(v_0, e_1, v_1, e_2, v_2, \dots, v_{n-1}, e_n, v_n) = d(e_1) + \dots + d(e_n)$ be the length of the route r . Let $d(u, v)$ be the distance between the vertices u and v on the graph G , i.e. the length of the shortest route $p(u, v)$ (= path if it is the shortest) from u to v .

Let $W \subset V \times V$, $W \neq \emptyset$ be the set of important pairs (e.g. origins and destinations of passenger batches), let $q_w \geq 1$ be a given number and let $d_w = d_{(u, v)} = q_w d(u, v) \geq d(u, v)$ be the upper limit for the length of a path connecting u and v for all $w = (u, v) \in W$.

Let, for each $w \in W$, $R(w, d_w)$ be the set of all mutually different routes connecting the endpoints of the pair w and meeting the constraint $d(r) \leq d_w$. Such routes are called **acceptable**.

The **1st stage** consist in finding the sets $R(w, d_w)$ of acceptable paths for all $w = (u, v) \in W$. It is done using a **depth-first-search procedure**, looking for all paths $u, e_1, u_1, e_2, u_2, \dots, e_n, u_n$ such that

$$d(e_1) + d(e_2) + \dots + d(e_n) + d(u_n, v) \leq d_w$$

Then the compound path $u, e_1, u_1, e_2, u_2, \dots, e_n, u_n, e_{n+1}, \dots, e_m, v$ is acceptable, if the length $d(u_n, e_{n+1}, \dots, e_m, v) = d(u_n, v)$.

The **2nd stage** chooses one route $r_w \in R(w, d_w)$ for all $w = (u, v) \in W$ in such a way that the total length of all edges belonging at least to one r_w is minimal.

4 LP MODEL FOR THE 2ND STAGE

Find binary variables x_e for each $e \in E$ and $y_{r,w}$ for each $w \in W$, $r \in R(w, d_w)$ meeting the following constraints:

$$10^4 x_e \geq \sum_{w \in W} \sum_{e \in r} y_{r,w} \quad \text{for each } e \in E \quad (1)$$

$$\sum_{r \in R(w, d_w)} y_{r,w} = 1 \quad \text{for each } w \in W, \quad (2)$$

$$\sum_{e \in E} d(e) x_e \rightarrow \min \quad (3)$$

Comment: $x_e = 1$ means that the edge $e \in E$ is chosen to the selected subnetwork, $x_e = 0$ means the opposite. $y_{r,w} = 1$ for $w \in W$ and $r \in R(w, d_w)$ if the connection of the pair $w = (u, v)$ will pass down the route r in the resulting subnetwork i.e. the route r is selected for the connection of the pair w .

The constraint (1) ensures, that the edge e will be chosen if it is passed by any selected route r . The constraint (2) ensures that exactly one route is selected for the connection of the pair w . (3) ensures that the total cost of the subgraph is minimal.

5 COMPUTING EXPERIENCE

The above described method has been implemented and tested on several, mainly randomly generated networks. The first part of the method, the algorithm which generates the set of possible networks, has been implemented in the environment of Visual Basic for Application in MS Access. The second part, the Integer LP problem, has been solved via freeware solver LP Solve IDE. The experiments have been carried out with the same hardware, environment and test networks as the experiments, whose results are described in [8]. This fact allows us directly compare the correctness of the method and computational times. Table 1 brings the comparison.

Table 1. Comparison of Methods

TN	ONV	ONE	ONL	q	NIP	One stage Exact method (EM)		New two stage exact method (NEM)			Heuristic method (HM)		Integer linear programming (LP)	
						RNL	CT [s]	RNL	CTp [s]	CTc [s]	RNL	CT [s]	RNL	CT [s]
1	20	30	213.3	1.2	13	88.5	1596	88.5	<1	<1	91.2	<1	88.5	3.5
				1.2	20	88.5	1053	88.5	<1	<1	88.5	<1	88.5	11.4
				1.5	13	72.8	12430	72.8	≈2	<1	82.5	1	72.8	2.4
				1.5	20	72.8	8844	72.8	≈2	<1	79.8	1	72.8	8.6
2	20	30	204.2	1.2	13	65.8	5205	65.8	<1	<1	65.8	<1	65.8	7
				1.2	20	65.8	3658	65.8	<1	<1	83.3	1	65.8	10.8
				1.5	13	54.9	7757	54.9	≈2	<1	65.8	1	54.9	9.5
				1.5	20	65.8	1194	65.8	≈2	<1	65.8	1	65.8	9.8
3	20	32	232.7	1.2	13	84.8	3033	84.8	<1	<1	89.5	1	84.8	7.9
				1.2	20	127.6	142	127.6	<1	<1	128.8	1	127.6	27.6
				1.5	13	78.6	146	78.6	≈2	<1	89.5	1	78.6	8.9
				1.5	20	99.9	2681	99.9	≈2	<1	122.4	1	99.9	31.8
4	20	30	204.6	1.2	13	74.1	2735	74.1	<1	<1	74.6	1	74.1	4.2
				1.2	20	103.0	226	103.0	<1	<1	105.3	1	103	17.5
				1.5	13	73.4	7884	73.4	≈2	<1	74.6	1	73.4	5.1
				1.5	20	85.2	1906	85.2	≈2	<1	87.4	1	85.2	19.7
5	20	29	209.6	1.2	13	87.7	485	87.7	<1	<1	99.7	<1	87.7	7.8
				1.2	20	103.5	41	103.5	<1	<1	112.6	1	103.5	11.5
				1.5	13	80.3	2479	80.3	≈2	<1	99.7	1	80.3	8.6
				1.5	20	90.4	555	90.4	≈2	<1	120.2	2	80.3	19.2
6	20	32	212.9	1.2	13	92.5	3168	92.5	<1	<1	128	1	92.5	13.6
				1.2	20	96.6	1611	96.6	<1	<1	138.5	1	96.6	46.7
				1.5	13	81.4	13856	81.4	≈2	<1	97.5	1	81.4	790.6
				1.5	20	96.6	7237	96.6	≈2	<1	108.2	1	U	-
7	20	31	176.5	1.2	13	48.3	16672	48.3	<1	<1	54.1	1	48.3	10.5
				1.2	20	59.9	2491	59.9	<1	<1	65.7	1	59.9	41.5
				1.5	13	48.3	17912	48.3	≈2	<1	54.1	1	48.3	8.1
				1.5	20	59.9	4818	59.9	≈2	<1	65.7	1	59.9	44.8
8	20	28	197.7	1.2	13	81.8	900	81.8	<1	<1	95.7	1	81.8	4.3
				1.2	20	91.8	347	91.8	<1	<1	115.2	1	91.8	15.2
				1.5	13	66.3	1606	66.3	≈2	<1	69.9	1	66.3	8.9
				1.5	20	66.3	730	66.3	≈2	<1	66.3	<1	66.3	17.9
9	20	30	191.6	1.2	13	115.2	11	115.2	<1	<1	137.9	2	115.2	6.8
				1.2	20	122.9	6	122.9	<1	<1	145.7	1	122.9	17.8
				1.5	13	75.3	2370	75.3	≈2	<1	101.5	1	75.3	25.7
				1.5	20	93.3	240	93.3	≈2	<1	125.5	1	93.3	64
10	30	47	271.9	1.2	13	U	-	78.1	<1	<1	95.8	1	78.1	15.9
				1.2	20	U	-	84.0	<1	<1	101.8	4	84	49
				1.5	13	U	-	58.8	≈2	<1	70.1	1	58.8	32.7
				1.5	20	U	-	75.8	≈2	<1	76.1	1	75.8	128.6
Piešťany	20	31	1285	1.1	20	992	16	992	<1	<1	1220	<1	992	379.5
				1.2	20	882	152	882	<1	<1	1220	<1	882	74.1
				1.3	20	763	1014	763	1	<1	866	<1	763	743.2
				1.4	20	763	4451	763	2	<1	866	<1	763	5907.1

The legend: TN = Test network, ONV = Number of vertices, ONE = Number of edges, ONL = Total length of the original network, NIP = Number of Important Pairs, RNL = Total length of the reduced network, CT = Computational time, CTp = Computational time of the algorithm which generates the set of possible paths, CTc = Computational time of the covering problem solved by LP, U = Solution was not reached in an acceptable time.

Observing the Table 1 one can see that tested two stage exact method has reached the same results as former tested combinatorial exact method and integer LP method. The computational times were significantly lower in comparison with the former methods. The solution has been reached in several seconds maximum in all cases of test networks. This fact is very important, because it allows using this method for more complex networks or as a part of solution of another significantly more complex problem.

6 CONCLUSION

The paper has showed that the new original two stage exact method works correctly and faster than the former one stage methods presented by Černá et al. [8].

Acknowledgements: This work was supported by The research was supported by the Czech Science Foundation Grant No. P 402/12/2147 „Economically Optimal Processes on Networks“ and by the Slovak research grants VEGA 1/0296/12 „Public Service Systems with Fair Access to Service“ and APVV-0760-11 „Designing of Fair Service Systems on Transportation Networks.“

References

- [1] Amini, O., Peleg, D., Pérennes, S., Sau, I. and Saurabh, S.(2009) ‘Degree-Constrained Subgraph Problems: Hardness and Approximation Results’, in Bampis, E. and Skutella, M. (ed.) *WAOA 2008, LNCS 5426*, Berlin: Springer-Verlag, pp. 29–42.
- [2] Borůvka, O. (1926) ‘O jistém problému minimálním (About a certain minimal problem)’, *Práce moravské přírodovědecké společnosti v Brně*, vol. III, pp. 37–58.
- [3] Berger, B. and Shor, P.W. (1990) ‘Approximation Algorithms for the Maximum Acyclic Subgraph Problem’ *SODA '90 – Conference Proceedings of the first annual ACM-SIAM symposium on Discrete algorithms*, Society for Industrial and Applied Mathematics, Philadelphia, pp. 236-243.
- [4] Cai, L. and Corneil, D.G. (1995) ‘Tree Spanners’, *SIAM Journal on Discrete Mathematics*, vol. 8, pp. 359-387.
- [5] Carr, R. and Ravi, R.(1998) ‘A New Bound for the 2-Edge Connected Subgraph Problem’, in Bixby, R. E., Boyd, E. A. and Rios-Mercado, R. Z. (ed.) *IPCO VI, LNCS 1412*, Berlin: Springer-Verlag, pp. 112-125.
- [6] Černá, A. and Černý, J. (2011) ‘Economically Optimal Subnetwork for Passenger Transport’, *Mathematical Methods in Economics 2009 – Conference Proceedings*, The Czech Society for Operations Research Conference, Janská dolina, Slovakia, pp. 101-106.
- [7] Černá, A., Černý, J., Peško, Š. and Czimmermann, P. (2007) ‘Network Reduction Problems’, *Journal of Information, Control and Management Systems*, vol. 5, pp. 139-147.
- [8] Černá, A., Černý, J. and Příbyl, V. (2014) ‘Economically Optimal Road Subnetwork’ *Communications*, vol. 16, no. 2, pp. 83-91
- [9] Cheriyan, J. and Thurimella, R. (2000) ‘Approximating Minimum-Size k-Connected Spanning Subgraphs via Matching’, *SIAM Journal on Computing*, vol. 30, pp. 528-560.
- [10] Cheriyan, J., Vempala, S. and Vetta, A. (2003) ‘An Approximation Algorithm for the Minimum-Cost k-Vertex Connected Subgraph’, *SIAM Journal on Computing*, vol. 32, pp. 1050-1055.
- [11] Czimmermann, P. (2014) ‘On a Certain Transport Network Reduction Problem’, *Journal of Information, Control and Management Systems*, vol. 8, pp. 21-24.
- [12] Drezner, Z. and Wesolowsky, G.O. (2003) ‘Network design: selection and design of links and facility location’, *Transportation Research Part A - Policy and Practice*, vol. 37, pp. 241-256.
- [13] Eades, P., Foulds, L. R. and Giffin, J. W. (1982) ‘An efficient Heuristic for Identifying a Maximum Weight Planar Subgraph’, *Combinatorial Mathematics IX, Lecture Notes in Mathematics* No. 952, Berlin: Springer-Verlag.
- [14] Fernandes, C.G. (1998) ‘A Better Approximation Ratio for the Minimum Size k-Edge-Connected Spanning Subgraph Problem’, *Journal of Algorithms*, vol. 28, pp. 105-124.
- [15] Ferrer, M., Serratos, F. and Valveny, E. (2007) ‘On the Relation Between the Median and the Maximum Common Subgraph of a Set of Graphs’, in Escolano, F. and Vento, M. (ed.) *GbRPR 2007, LNCS 4538*, Berlin: Springer-Verlag, pp. 351–360.

- [16] Gabow, H.N., Goemans, M.X., Tardos, E. and Williamson, D.P. (2005) ‘Approximating the Smallest k -Edge Connected Spanning Subgraph by LP-Rounding’, *SODA '05 – Conference Proceedings of the sixteenth annual ACM-SIAM symposium on Discrete algorithms*, Society for Industrial and Applied Mathematics, Philadelphia, pp. 562-571.
- [17] Gao, Z.Y., Wu, J.J. and Sun, H.J. (2005) ‘Solution algorithm for the bi-level discrete network design problem’, *Transportation Research Part B - Methodological*, vol. 39, pp. 479-495.
- [18] Gutiérrez, J. and García-Palomares, J.C. (2007) ‘New spatial patterns of mobility within the metropolitan area of Madrid: Towards more complex and dispersed flow networks’, *Journal of Transport Geography*, vol. 15, pp. 18-30.
- [19] Hintsanen, P. (2007) ‘The Most Reliable Subgraph Problem’, in Kok, J.N. et al. (ed.) *PKDD 2007, LNAI 4702*, Berlin: Springer-Verlag, pp. 471–478.
- [20] Jenelius, E. (2009) ‘Network structure and travel patterns: explaining the geographical disparities of road network vulnerability’, *Journal of Transport Geography*, vol. 17, pp. 234-244.
- [21] Kelly, M.E. and Niedzielski, M.A. (2008) ‘Efficient spatial interaction: attainable reductions in metropolitan average trip length’, *Journal of Transport Geography*, vol. 16, pp. 313-323.
- [22] Meng, Q., Yang, H. and Bell, M.G.H. (2002) ‘An equivalent continuously differentiable model and a locally convergent algorithm for the continuous network design problem’, *Transportation Research Part B – Methodological*, vol. 35, pp. 83-105.
- [23] Meng, Q. and Yang, H. (2002) ‘Benefit distribution and equity in road network design’, *Transportation Research Part B – Methodological*, vol. 36, pp. 19-35.
- [24] Miandoabchi, E., Zanjirani Farahani, R. and Szeto, W.Y. (2012) ‘Bi-objective bimodal urban road network design using hybrid metaheuristics’, *CEJOR*, vol. 20, pp. 583-621.
- [25] Poorzahedy, H. and Abulghasemi, F. (2005) ‘Application of Ant System to network design problem’, *Transportation*, vol. 32, pp. 251-273.
- [26] Poorzahedy, H. and Rouhani, O. (2007) ‘Hybrid meta-heuristic algorithms for solving network design problem’, *European Journal of Operational Research*, vol. 182, pp. 578-596.
- [27] Safari, M.A. and Salavatipour, M.R. (2008) ‘A Constant Factor Approximation for Minimum λ -Edge-Connected k -Subgraph with Metric Costs’, in Goel, A. et al. (ed.) *APPROX and RANDOM 2008, LNCS 5171*, Berlin: Springer-Verlag, pp. 233–246.
- [28] Suzuki, A. and Tokuyama, T. (2005) ‘Dense subgraph problem revisited’, *Proc. Joint Workshop “New Horizons in Computing” and “Statistical Mechanical Approach to Probabilistic Information Processing”*, 18-21 July, Sendai, Japan, pp. 1-2.
- [29] Vassilevska, V., Williams, R. and Yuster, R. (2006) ‘Finding the Smallest H -Subgraph in Real Weighted Graphs and Related Problems’, in Bugliesi, M. et al. (ed.) *ICALP 2006, Part I, LNCS 4051*, Berlin: Springer-Verlag, pp. 262–273.
- [30] Xie, F. and Levinson, D. (2009) ‘Modeling the Growth of Transportation Networks: A Comprehensive Review’, *Networks and Spatial Economics*, vol. 9, pp. 291-307.
- [31] Yang, H. and Bell, M.G.H. (1998) ‘Models and algorithms for road network design: a review and some new developments’, *Transport Reviews*, vol. 18, pp. 257-278.

Author’s address

Prof. RNDr. Jan Černý, DrSc., dr. h. c.
University of Economics in Prague, Faculty of Management,
Department of Exact Methods,
Jarošovská Street 1117/II, 37701 Jindřichův Hradec
Czech Republic
email: cerny@fm.vse.cz

HEURISTIC AND EXACT METHODS FOR THE LOCATION OF AMBULANCE STATIONS

*Anna Černá¹, Jan Černý¹, Josef Volek²,
University of Economics in Prague¹
University of Pardubice²*

Abstract

The paper deals with the following question concerning the given road network and the set of selected “important” vertices: Where to locate ambulance stations minimizing the costs and ensuring accessibility by ambulance vehicles within the time limit? The paper suggests two exact optimal methods leading almost surely to better results, than the natural approach of a “greedy” type used in Czech Republic.

Keywords: *location, ambulance station, optimization, allocation of vehicles, method*

JEL Classification: I18, C65

AMS Classification: 05C90, 90C35

1 INTRODUCTION AND MOTIVATION

This paper deals with the formulation and solution of problems involving the optimal placement (location) of habitats (posts) of emergency ambulance services, briefly SAMU (Service d'Aide Médicale Urgente in French). Even though it is a problem that is solved globally, the mathematical solution can be influenced by the specifics of each country. The following mathematical approach will reflect the health care system in Czech Republic.

1.1 Czech Situation in SAMU Location

In the current conditions of the Czech Republic's decision to issue belongs to the county administration. Its topicality is argued by the fact that each Czech region is still expanding the set of these habitats. E.g. the Region Central Bohemia had their number 44 in 2014, as stated on the website of the Territorial SAMU [9]. Similar situation is in the other Czech regions.

Hereat, one can say that it is always an extension by adding one post. The deciding is not based on any scientific method, but a simple consideration based on the time availability of positions of possible intervention. As the new location is then selected the post, from which will maximally expand the number of places reachable within 20 minutes.

In terms of systems theory, it is a method of successive elementary steps, each of them selecting the option that best improves the current state. Therefore, it is a so-called greedy method, which is generally only a heuristic, but not exactly optimal as easily seen in Figure 1. It shows a graph of a network of seven variously connected vertices $A-F$, each edge of the graph has a transit duration of 12 min. Assume that of potential patients live in each vertex and also to each node can put post of a SAMU. The task is to find the fewest set of location posts so that any one vertex is reachable from them in 20 min.

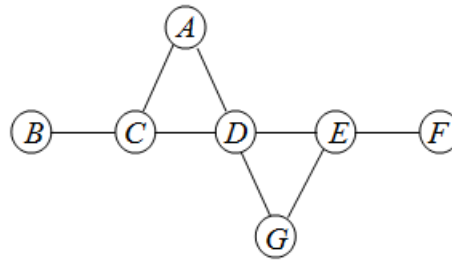

Fig. 1. Example of a network

In the first step, a post is placed into the node D , because the greatest number of other nodes is reachable from it within 20 minutes. They are four: A, C, E, G . The vertices B and F do not meet the limit since they are reachable from D within 24 min. Afterwards, in the following two steps, it is necessary to place two post more. One in B or C and other one in E or F . Hence, using the natural greedy heuristics, the resulting set of SAMU posts which covers the network in the sense of 20 min reachability, contains 3 elements, although it is obvious that the optimal solution equals to the set $\{C, E\}$ with 2 elements. The above example shows that after a few steps in the spirit of greedy approach it is advisable to calculate the overall optimal location using an exact method.

The problem of optimal placement (location) of SAMU habitats can be presented in several variants, differing mainly in constraints which any feasible solution should meet and in objective function whose maximum resp. minimum value will indicate the optimal solution. Although this is a problem of managerial decision making in health care, it turns out that by its nature it belongs to the theory of transport networks, represented by graphs with "time" edge lengths.

1.2 Brief Overview of Literature

The survey paper [8] presents several applications of operations research in the domain of health care, including SAMU. A wide survey of different location problems and methods of solution can be found in [2]. Another survey paper [7] describes Location Set Covering Problem (LSCP), Maximal Covering Location Problem (MCLP), Double Standard Model (DSM), Maximum Expected Covering Location Problem (MEXCLP), and Maximum Availability Location Problem (MALP) models. In [3] one can find an integer optimization model to decide locations and types of service station under service constraints in order to minimize the total cost of the overall system. [6] deals with ambulance location optimization model that minimizes the number of ambulances needed to provide a specified service level in the case of random delays and travel times. [5] presents a simulation model enabling to observe effect of SAMU locations and number of ambulances onto the quality of emergency service. The SAMU location model of [4] incorporates a survival function. The paper [1] extends the traditional location problem to a goal programming version with two goals: 1. The maximum expected demand can be reached within a pre-specified target time. 2. Any demand arising within the service area of the station will find at least one vehicle,

2 MATHEMATICAL MODEL

Czech legislation requires driving of the ambulance to the patient within $q = 20$ minutes. It is supposed the vehicle uses the road network represented by an undirected graph $G = (V, E, d)$, where V is the vertex set, E is the edge set and $d : H \rightarrow \langle 0; \infty \rangle$ is a duration function, $d(e)$ is the duration of transit through the edge $e = (v, w)$, i.e., the time distance between v and w . Moreover, it is supposed that the post of SAMU can be chosen among the vertices from a set $W \subset V$. Then the problem of optimal location of SAMU posts can be formulated as follows.

2.1 Problem

Let G be a given graph as above, let $W \subset V$, $W \neq \emptyset$ and let $q > 0$. The problem is to find a subset $S \subset W$ having the minimal possible number of elements $|S|$, meeting the constraint

$$d(v, S) \leq q \quad \text{for each } v \in V. \quad (1)$$

Remark. The symbol $d(v, S)$ denotes the time distance of the vertex v from the set S , i.e.,

$$d(v, S) = \min\{d(v, s) : s \in S\}$$

where $d(v, s)$ means the time distance between the vertices v and s on G .

Comment. This is a generalization of the role of p -center in a graph in the sense that location of p -center is limited to the set W , and we are looking for the smallest p for which there exists such a subset $S \subset W$ for which (1) holds.

2.2 Problem Reformulation

Problem 2.1 can be reformulated into a **Set Covering Problem**. The set W will be covering and V covered. Let $V_w = \{v \in V : d(v, w) \leq q\}$ be the subset of V covered by the vertex w for each $w \in W$. The problem is to find such a subset $S \subset W$ that

$$\bigcup_{w \in S} V_w = V$$

and $|S|$ is minimal.

Corollary. The problem 2.1 is NP-hard.

3 SOLUTION

Three solution methods are presented for the problem 2.1.

3.1 Solution of Problem 2.1 by Greedy Heuristics

1st step: Find a vertex $s_1 \in W$, for which $V_1 = \{v \in V : d(s_1, v) \leq q\}$ has the following property: For all $w \in W$ it holds that $|V_1| \geq |\{v \in V : d(w, v) \leq q\}|$. Put $i = 1$. Continue by 2nd step.

2nd step: If $V_1 \cup \dots \cup V_i = V$ then $S = \{s_1, \dots, s_i\}$ is the resulting set. Otherwise put $j = i + 1$ and find such a vertex $s_j \in W - \{s_1, \dots, s_i\}$ that $V_j = \{v \in V - V_1 - \dots - V_i : d(s_j, v) \leq q\}$ has the following property: For all $w \in W$ it holds that $|V_j| \geq |\{v \in V - V_1 - \dots - V_i : d(w, v) \leq q\}|$. Put $i = j$ and turn to the beginning of the 2nd step.

3.2 Solution of Problem 2.1 by Exact Depth First Search Method

Suppose (without loss of generality) $V = \{1, \dots, m, m + 1, \dots, n\}$ and further $W = \{1, \dots, m\}$. The root of the tree of solutions, i.e. the vertex of the level 0 is the set W , the neighboring vertices are $W_1 = W - \{1\}, \dots, W_m = W - \{m\}$. At the vertices of level 2, which are adjacent to the ones of level one and contain W reduced by 2 elements, these elements are always written increasingly, for example $W_{24} = W - \{2, 4\}$ and not e.g. $W_{42} = W - \{2, 4\}$. This rule applies at higher levels as well. For $m = 4$ a $W = \{1, 2, 3, 4\}$, an example of such a tree is on Fig 2.

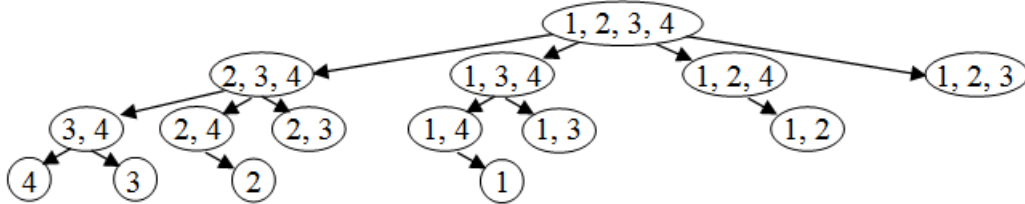

Fig 2. Example of solution tree

At the beginning we choose $S = W$. If S does not satisfy the condition (1) we are done, the problem has no solution 2.1. Otherwise, the candidate for the optimal solution is each vertex of the tree, which satisfies the condition (1), but no such adjacent vertex in lower level exists. The search continuous any times through unexplored arrows, left down first, if not possible then right down until a candidate is met. Then a step back follows and the procedure continuous until any unexplored arc is reachable. The optimal solution is then the set, represented by the vertex-candidate at the lowest possible level, because it means that it has the smallest possible number of elements.

3.3 Solution of Problem 2.1 by Integer Linear Programming

Suppose again $V = \{1, \dots, m, m + 1, \dots, n\}$ and $W = \{1, \dots, m\}$. Denote $d_{ij} = d(i, j)$ in G . Let

$$D = \sum_{\substack{i \in \{1, \dots, n\}, \\ j \in \{1, \dots, m\}}} d_{ij}$$

be a “big number”, a substitute of ∞ . The **problem** is to find

$$x_j \in \{0, 1\}, j \in \{1, 2, \dots, m\}, \tag{2}$$

$$y_{ij} \in \{0, 1\}, i \in \{1, 2, \dots, n\}, j \in \{1, 2, \dots, m\}, \tag{3}$$

meeting the constraints

$$y_{ij} \leq x_j \text{ for } i \in \{1, 2, \dots, n\}, j \in \{1, 2, \dots, m\}, \tag{4}$$

$$d_{ij} y_{ij} \leq q \text{ for } i \in \{1, 2, \dots, n\}, j \in \{1, 2, \dots, m\}, \tag{5}$$

$$\sum_{j \in \{1, \dots, m\}} y_{ij} = 1 \text{ for } i \in \{1, 2, \dots, n\}, \tag{6}$$

$$\sum_{j \in \{1, \dots, m\}} d_{ij} y_{ij} \leq d_{ik} x_k + D(1 - x_k) \text{ for } i \in \{1, 2, \dots, n\}, k \in \{1, 2, \dots, m\}, \tag{7}$$

and minimizing the objective

$$\sum_{j \in \{1, \dots, m\}} x_j \rightarrow \min \tag{8}$$

The value $x_j = 1$ means that the vertex j is selected to the set S , the value $y_{ij} = 1$ means that the vertex j is the closest vertex of S to the vertex i . Condition (4) ensures that, for the vertex i , the closest vertex j belongs to S , (5) provides meeting the condition (1), (6) ensures that the closest is only one vertex, (7) selects the closest vertex j to i and then (8) ensures the number of selected vertex in S to be minimal.

4 CONCLUSION

The paper has shown that the problem of the optimal placement (location) of habitats (posts) of emergency ambulance services, briefly SAMU, is topical and widely studied in many countries. However, the specifics of health care systems in the different states may cause different constraints and objectives and, therefore, different mathematical models of solution. In Czech Republic a natural greedy type approach is used and its results are not optimal probably. The paper has suggested two exact optimal methods leading almost surely to better results.

Acknowledgements: This work was supported by the Czech Science Foundation Grant No. P402/12/2147 “*Economically Optimal Processes on Networks*“.

References

- [1] Alsalloum, O.I. and Rand, G.K. (2006) ‘Extensions to emergency vehicle location models’, *Computers & Operations Research*, vol. 9, pp. 2725-2743.
- [2] Basar, A., Catay, B. and Unluyurt, T. (2012) ‘A taxonomy for emergency service station location problem’, *Optimiztion Letters*, vol. 6, pp. 1147-1160.
- [3] Coskun, N. and Erol, R. (2010) ‘An Optimization Model for Locating and Sizing Emergency Medical Service Stations’, *Journal of Medical Systems*, vol. 34, pp. 43-49.
- [4] Erkut, E., Ingolfsson, A. and Erdogan, G. (2008) ‘Ambulance location for maximum survival’, *Naval Research Logistics*, vol. 55, pp. 42-58.
- [5] Inakawa, K., Furuta, T. and Suzuki, A. (2010) ‘Effect of Ambulance Station Locations and Number of Ambulances to the Quality of the Emergency Service’, *Operations Research and its Applications*, vol. 12, pp. 340-347.
- [6] Ingolfsson, A., Budge, S. and Erkut, E. (2008) ‘Optimal ambulance location with random delays and travel times’, *Health Care Management Science*, vol. 11, pp. 262-274.
- [7] Li, X., Zhao, Z.X., Zhu, X. and Wyatt, T. (2011) ‘Covering models and optimization techniques for emergency response facility location and planning: a review’, *Mathematical Methods of Operations Research*, vol. 74, pp. 281-310.
- [8] Rais, A. and Viana, A. (2011) ‘Operations Research in Healthcare: a survey’, *International Transactions in Operational Research*, vol. 18, pp. 1–31.
- [9] Soucasnost-zzs-stredoceskeho-kraje, [Online], Available: <http://www.uszssk.cz/historie> [1 Mar 2014]

Author’s address

Doc. Ing. Anna Černá, CSc. (corresponding author)
 University of Economics in Prague, Faculty of Management, Department of Exact Methods
 Jarošovská 1117/II, 377 01 Jindřichův Hradec
 Czech Republic
 email: cerna@fm.vse.cz

INTERVAL DATA AND REGRESSION MODELS: SOME NOTES, APPLICATIONS AND PROBLEMS

Michal Černý
University of Economics, Prague

Abstract

In this paper we compare the possibilistic and probabilistic approach to econometric regression with interval data. Here, interval data are understood in the following sense: a regression model involves unobservable variable(s), either dependent or independent, and information available to us is limited only to a collection of intervals such that it is guaranteed that they cover the unobservable value. We provide an example of a simple consumption model with anticipated inflation which is given as an interval of predictions. We show examples when an assumption of uniform distribution on the observed interval leads to a bias. We show some examples of interval-generating processes which help in inference about the interval-valued regression model. Finally, we summarize some general research questions.

Keywords: interval data, linear regression, possibilistic approach, probabilistic approach

JEL Classification: C18

AMS Classification: 62P20, 91G70

1 INTRODUCTION

In practice we often meet interval data. Examples include data affected by rounding, categorization, some kinds of censoring, or discretized continuous data. Another source of interval data is prediction: for example, future weather or inflation is often predicted as an interval of likely/possible values. Sometimes we need to deal with unobservable data; then it might be appropriate to use an interval which is assumed to cover the unobservable data point. Further examples and motivation can be found e.g. in [1, 2, 5, 6, 7, 9].

Consider the linear regression model

$$y = X\beta + \varepsilon, \quad (1)$$

where y denotes the dependent variable, X denotes the matrix of regressors, β is the vector of regression parameters and ε stands for disturbances. In the entire paper we will use n for the number of observations and p for the number of regression parameters.

The pair (X, y) is called *data* for model (1). We study the case when data are unobservable. What is observable instead is a 4-tuple $(\underline{X}, \bar{X}, \underline{y}, \bar{y})$ such that we know

$$\underline{X} \leq X \leq \bar{X}, \quad \underline{y} \leq y \leq \bar{y}. \quad (2)$$

(An inequality between matrices/vectors is understood componentwise.) When we observe only $(\underline{X}, \bar{X}, \underline{y}, \bar{y})$ instead of (X, y) , we speak about *linear regression with interval data*.

Now a natural question arises. Let $S(X, y)$ be a statistic (as an example consider the least-squares estimator of a regression parameter or Residual Sum of Squares). What can we infer about $S(X, y)$ from the observable data $(\underline{X}, \bar{X}, \underline{y}, \bar{y})$? The answer heavily depends on available information about the distribution of $(X, \underline{X}, \bar{X}, y, \underline{y}, \bar{y})$. If the only available information to us is (2), then we can only derive the values

$$\begin{aligned}\bar{S} &= \sup\{S(\Xi, \nu) : \Xi \in [\underline{X}, \bar{X}], \nu \in [\underline{y}, \bar{y}]\}, \\ \underline{S} &= \inf\{S(\Xi, \nu) : \Xi \in [\underline{X}, \bar{X}], \nu \in [\underline{y}, \bar{y}]\},\end{aligned}\tag{3}$$

bounding the distribution of $S(X, y)$ given the observed data $(\underline{X}, \bar{X}, \underline{y}, \bar{y})$. In other words, the interval $[\underline{S}, \bar{S}]$ covers the “inaccessible” value $S(X, y)$. On the other hand, in some situations we can strengthen the assumptions (2): for example, it might be appropriate to assume a particular distribution of X and y on $[\underline{X}, \bar{X}]$ and $[\underline{y}, \bar{y}]$, respectively. Our knowledge of that distribution will help us derive the distribution of $S(X, y)$ on $[\underline{S}, \bar{S}]$, or at least some partial information about this distribution.

When we cannot make an assumption on the distribution, we can work only with the interval $[\underline{S}, \bar{S}]$. This approach is referred to as *possibilistic approach* [2, 4], meaning that we are guaranteed that $S(X, y) \in [\underline{S}, \bar{S}]$ for every possible distribution of X and y on $[\underline{X}, \bar{X}]$ and $[\underline{y}, \bar{y}]$, respectively. On the other hand, when we make an assumption of a particular distribution of X and y given $(\underline{X}, \bar{X}, \underline{y}, \bar{y})$, we speak about *probabilistic approach*.

Both approaches, the possibilistic and the probabilistic one, have been studied in statistics and econometrics in the more general context of partial identification, see [8, 11, 13, 14].

2 UNIFORM DISTRIBUTION ON THE INTERVALS?

It is always tempting to prefer the probabilistic approach to the possibilistic one. Probabilistic assumptions strengthening (2) facilitate estimation and inference. An assumption on a particular distribution of X and y on $[\underline{X}, \bar{X}]$ and $[\underline{y}, \bar{y}]$, respectively, allows us to construct e.g. maximum-likelihood estimators or use simulations for derivation of various characteristics of the distribution of $S(X, y)$.

Usually, the first idea coming to mind is usage of the uniform distribution. This can be justified e.g. by the fact that we do not have a priori information that some values should be preferred to others. Sometimes this insight might be useful and sometimes it might be misleading.

We illustrate the problem by an example of econometric regression

$$C_t = \beta_1 + \beta_2 YD_t + \beta_3 \pi_t^E + \varepsilon_t,\tag{4}$$

where t is index of time, C_t denotes consumption expenditures, YD_t denotes disposable income and π_t^E denotes inflation for time $t + 1$ expected in time t . Assume that inflation expectations are driven by expert predictions, which are available as intervals $[\underline{\pi}_t^E, \bar{\pi}_t^E]$. It now depends on the particular mechanism how the economic subject forms its inflation expectation π_t^E . Or, said otherwise, it depends on the mechanism *how the economic subject chooses a particular value* π_t^E from the given interval $[\underline{\pi}_t^E, \bar{\pi}_t^E]$ when making the decision about its consumption expenditures. If we can assume independence and uniform distribution (say) of π_t^E on $[\underline{\pi}_t^E, \bar{\pi}_t^E]$ – that is, we assume that the subject chooses the value π_t^E from $[\underline{\pi}_t^E, \bar{\pi}_t^E]$ at random, independently of other choices – then we can construct estimators for $\beta_1, \beta_2, \beta_3$ (at least numerically or using simulations) and make inference about the model.

However, the uniform-distribution assumption might be highly misleading, resulting in a significant bias. Assume that an expert predicting inflation simply wants to say “I don’t know”. Then, she might express this opinion in a way that “I can confirm only that next year’s inflation will be nonnegative and at most 100%”. In other words, she provides the economic subject with

an interval $[\underline{\pi}_t^E, \bar{\pi}_t^E] = [0\%, 100\%]$ in some period t . Then it is clear that the assumption of uniform distribution of π_t^E on $[\underline{\pi}_t^E, \bar{\pi}_t^E]$ is inappropriate: it would imply that “on average” the economic subject chooses the value 50%. Under standard economic conditions, true inflation is completely different.

3 THE POSSIBILISTIC APPROACH AND TESTING HYPOTHESES

Though the possibilistic approach seems to be very weak, just working with the interval $[\underline{S}, \bar{S}]$ given by (3), it is (at least sometimes) also useful in the probabilistic context. In particular, it can help in testing hypotheses. Let $S = S(X, y)$ be a test statistic for a particular test; for example, let S stand for the t -ratio for testing the hypothesis that a given regression coefficient is zero. Then the interval $[\underline{S}, \bar{S}]$ given by (3) gives bounds for the value of t -ratio. Let C_α be the critical region for the test statistic S at a given fixed level of confidence α . Now three cases can occur:

- When $[\underline{S}, \bar{S}] \subseteq C_\alpha$, we know that the test *rejects* the null hypothesis on the α -level; and we know this *without* the need of any stronger probabilistic assumptions than (2). (In this sense we can say that the conclusion is robust.)
- When $[\underline{S}, \bar{S}] \cap C_\alpha = \emptyset$, we know that the test *does not reject* the null hypothesis on the α -level; and again, we know this *without* the need of stronger assumption than (2).
- Neither of the previous cases occurs. Then we cannot conclude.

Of course, it is tempting to analyze the last case further; intuition tells us, for example, that when the intersection of $[\underline{S}, \bar{S}]$ with C_α is nonempty but “small”, the test is “likely” not to reject the null hypothesis. However, a rigorous analysis of such case would require additional probabilistic assumptions, switching us from the possibilistic to the probabilistic approach. Notwithstanding, this question deserves attention and further investigation.

4 INTERVAL-GENERATING PROCESSES

There are many natural processes generating interval data. Let us give a pair of examples. We restrict ourselves to interval-generating processes for the dependent variable y . Of course, similar ideas apply also for X .

Example 1. Rounding. Assume that data y_1, \dots, y_n are available only in the rounded form. Then, only interval data

$$\underline{y}_i = \lfloor y_i \rfloor, \quad \bar{y}_i = \lceil y_i \rceil, \quad i = 1, \dots, n \quad (5)$$

are observable. This case is well-studied in statistical literature; the most important result in the theory of rounding is Sheppard’s Correction, see [12].

Example 2. Additional random error model assumes that there are nonnegative random variables γ_i, δ_i such that

$$\underline{y}_i = y_i - \gamma_i, \quad \bar{y}_i = y_i + \delta_i, \quad i = 1, \dots, n. \quad (6)$$

An interesting special case is when

$$\gamma_i \sim \text{Unif}(0, 0.5) \text{ independent}, \quad \delta_i = \gamma_i, \quad i = 1, \dots, n. \quad (7)$$

This case is referred to as (a form of) *probabilistic rounding*; see [12].

Example 3. Discretization of continuous data. Let $Y(t)$ be a random process with time $t \geq 0$. Consider times $t_i \in [i-1, i)$ in which an event occurs; we are interested in the values

$$y_i = Y(t_i), \quad i = 1, \dots, n. \quad (8)$$

Assume that y_i are unobservable; the only information available to us are daily spreads of $Y(t)$, i.e.

$$\underline{y}_i = \inf\{Y(t) : t \in [i-1, i)\}, \quad \bar{y}_i = \sup\{Y(t) : t \in [i-1, i)\}, \quad i = 1, \dots, n. \quad (9)$$

Then we have $\underline{y}_i \leq y_i \leq \bar{y}_i$ for every i . This situation occurs e.g. when stock exchange quotes are reported as daily min's and max's.

Example 4. Another model. Assume that the process $Y(t)$ from Example 3 is observable, while the times t_1, \dots, t_n are unobservable. Again, let data y_i be given by (8).

When we cannot make assumptions on the distribution of t_1, \dots, t_n , then we are in a similar situation as in Example 3: from observability of $Y(t)$ we can derive only intervals $[\underline{y}_i, \bar{y}_i]$ as in (9). However, it is a more interesting case when an assumption of a particular distribution of t_i is available: then we can utilize the information from the observed trajectory of $Y(t)$.

5 PROBLEMS, QUESTIONS AND CONCLUSIONS

Both approaches, the possibilistic and the probabilistic one, are complementary. The previous sections illustrated that under some conditions we should restrict ourselves to the possibilistic approach only, while in other cases we can use additional assumptions and data, such as the (estimated) distribution of γ_i, δ_i in Example 2 or the trajectory of the process $Y(t)$ in Example 4, to derive stronger information about the statistic $S(X, y)$ under consideration.

In literature, much effort has been devoted to both approaches. In particular, formulation (3) shows that the possibilistic approach reduces to solving a pair of optimization problems, showing an interesting connection between regression and optimization. The optimization problems (3) have been investigated by many authors, in particular from the algorithmic perspective, see e.g. [3, 10]. In general, the results are quite disappointing: it often turns out that even for simple statistics S , such as the coefficient of determination, just solution of (3) is a computationally hard problem (usually formalized as an NP-hard or inapproximable problem). This shows that even the "simplest" approach has its bottlenecks. Here the bottlenecks are in computational complexity.

Many interesting general questions about regression with interval data can be illustrated by the simple consumption model (4). We conclude with two of them. *When only intervals $[\underline{\pi}_t^E, \bar{\pi}_t^E]$ are available,*

- *how to decide whether the uniform-distribution assumption is appropriate?*
- *which processes of selection of the value $\underline{\pi}_t^E \in [\underline{\pi}_t^E, \bar{\pi}_t^E]$ by the consumer can appear in economic reality and how should they be reflected in estimation and inference? (The value-selection process in this example is an analogy of the interval-generating process of Section 3.)*

Acknowledgments: The work was supported by the Czech Science Foundation Grant P403/12/1947.

References

- [1] Billard, L. and Diday, E. (2006) *Symbolic data analysis: Conceptual statistics and data mining*, Hoboken: Wiley.
- [2] Černý, M., Antoch, J. and Hladík, M. (2013) ‘On the possibilistic approach to linear regression models involving uncertain, indeterminate or interval data’, *Information Sciences*, vol. 244, pp. 24-47.
- [3] Černý, M. and Hladík, M. (2013) ‘Complexity of computation and approximation of the t -ratio over one-dimensional interval data’, *Computational Statistics & Data Analysis*, (submitted).
- [4] Černý, M. and Rada, M. (2011) ‘On the possibilistic approach to linear regression with rounded or interval-censored data’, *Measurement Science Review*, vol. 11, pp. 34-40.
- [5] He, L. T. and Hu, C. (2009) ‘Impacts of interval computing on stock market variability forecasting’, *Computational Economics*, vol. 33, pp. 263-276.
- [6] Hladík, M. and Černý, M. (2012) ‘Interval regression by tolerance analysis approach’, *Fuzzy Sets and Systems*, vol. 193, pp. 85-107.
- [7] Kreinovich, V. (1995) ‘Why intervals? A simple limit theorem that is similar to limit theorems from statistics’, *Reliable Computing*, pp. 33-40.
- [8] Manski, C. F. and Tamer, E. (2002) ‘Inference on regressions with interval data on a regressor or outcome’, *Econometrica*, vol. 70, pp. 519-546.
- [9] Marupally, P. R., Paruchuri, V. and Hu, C. (2012) ‘Bandwidth variability prediction with rolling interval least squares (RILS)’, *50th Annual Southeast Regional – Conference Proceedings*, New York: ACM, pp. 209-213.
- [10] Nguyen, H. T., Kreinovich, V., Wu, B. and Xiang, G. (2012) ‘Computing statistics under interval and fuzzy uncertainty. Applications to computer science and engineering’, *Studies in Computational Intelligence*, vol. 393, Berlin: Springer.
- [11] Rigobon, R. and Stoker, T. M. (2007) ‘Estimation with censored regressors: Basic issues’, *International Economic Review*, vol. 48, pp. 1441-1467.
- [12] Schneeweiss, H., Komlos, J. and Ahmad, A. S. (2010) ‘Symmetric and asymmetric rounding: a review and some new results’, *Advances in Statistical Analysis*, vol. 94, pp. 247-271.
- [13] Stoye, J. (2010) ‘Partial identification of spread parameters’, *Quantitative Economics*, vol. 1, pp. 323-357.
- [14] Tamer, E. (2010) ‘Partial identification in econometrics’, *Annual Review of Economics*, vol. 2, pp. 167-195.

Author’s Address:

Michal Černý

University of Economics, Prague, Faculty of Computer Science and Statistics, Department of Econometrics

Winston Churchill Square 4, 13067 Prague

Czech Republic

email: cernym@vse.cz

PRICE DIFFERENTIATION OF A MONOPOLY PRODUCTION – MICROECONOMIC ANALYSIS

*Michal Fendek,
University of Economics in Bratislava*

ABSTRACT

Due to a specific position which the subjects on a supply side have on an imperfect competition market, the producers can promote their interests without immediate danger of a competitor producing the same or similar product entering a relevant market.

In this article we discuss the general aspects of quantitative analysis of the monopoly price differentiation models and we will analyze in more detail the models of consumer's utility maximization in the conditions of price differentiation of the goods and a model of monopoly's profit maximization with price-differentiated production.

We will analyze a role of consumer's behavior optimization when the consumer's willingness to spend his funds on goods with differentiated prices is related to maximization of his total utility. For the optimization problems we will formulate the Kuhn-Tucker optimality conditions and we will study their interpretation options.

Keywords: price differentiation, consumer and monopoly behavior optimization, Lagrange function, Kuhn-Tucker optimality conditions, first, second and third degree price differentiation

JEL Classification: J2

AMS Classification: 91B40

INTRODUCTION

One of the effective tools to use monopoly's market position or economic power to, according to its interests, set a market price to the level which guarantees maximum profit, is a price differentiation. We can speak of a price differentiation in a situation when the identical products are being sold at different prices while this inequality is not due to different production costs. In literature price discrimination [Pepall, 2008] is often used as a synonym to price differentiation. We think, however, that this collocation has a slightly negativistic tone which does not correspond to its factual technical meaning, therefore following we will prefer price differentiation to indicate this microeconomic attribute.

We may speak of monopoly price differentiation when a monopoly uses its market position, or economic strength to define – in accordance with its interests – a market price on the level guaranteeing maximum profit. Ultimately the monopoly uses its monopolistic position to generate a monopoly profit over and above the profit achievable in the conditions of perfect competition.

In this article we will analyze a role of a consumer behavior optimization, whose willingness to spend his funds to purchase a good with a differentiated price is related to maximization of his total utility.

1. Conditions for Price Differentiation

Price differentiation is of course possible only under an assumption that a consumer is willing to pay different prices for different amounts of goods. That is, for example, at a lower price he is willing to purchase more – the price-demand function is decreasing.

If a price differentiation can be applied then in fact a monopoly uses its monopolistic position to gain monopolistic profit. A tool for this is a market price while a monopoly can use price differentiation in following areas:

- to set a different price when purchasing different amounts of a same good,
- to set a different price for different consumers or consumer groups.

In a first case it is relatively simple to use a price differentiation. When meeting the conditions of purchasing volume an agreed discount is given. To successfully apply the second method of a price differentiation a mechanism must exist to identify a consumer belonging to a certain consumer group. In literature [Waldman, 2006], we can find three types of price differentiation according to traditional classification:

(a) First degree price differentiation. This type of price differentiation of a monopolistic company is sometimes called a perfect price differentiation. A monopoly uses its privileged position on a market to set different prices for different volumes of a same product as well as for different consumer groups. Meaning that a seller in fact sets an individual price for each unit of a product and a price of a certain unit corresponds with a willingness to pay a maximum price by a certain consumer at a certain conditions.

(b) Second degree price differentiation represents a situation when the product prices depend on the purchasing volume of the products but do not depend on any characteristic a consumer may have. This phenomenon of pricing is also interpreted as a nonlinear pricing. Identical pricelists apply to all consumers but the pricelists vary for different purchasing volumes. A monopoly thus does not differentiate prices for particular consumers or consumer groups. The differentiation applies to varying amounts of purchased goods. An example of this approach to price differentiation is a volume rebate.

(c) Third degree price differentiation. With this type of price differentiation a monopolistic company sells any amount of goods at a same unit price. The price varies however for a specifically defined consumer groups. Third degree price differentiation represents probably the most common form of price differentiation. These are for example various types of discounts for students, child or pensioner's travel tickets, different prices on a different days (weekend discounts) and so on.

2. Monopoly profit maximization model in the conditions of perfect price differentiation

While formulating the model, we will assume a somewhat simplified assumption that on a relevant market there is only one "average" or "aggregated" consumer who experiences utility expressed in monetary units by a real utility function $u(x)$ while purchasing x units of a product. A monopoly uses this situation in a way that it offers such a combination of price and supply (p^*, x^*) , which maximizes monopoly's profit.

We have to realize, however, that a monopoly offers "all or nothing" choice, meaning that price p^* is valid only in case of purchasing exactly x^* units of a product with differentiated price and monopoly revenue will be $r^* = p^*x^*$. In other words, a consumer either purchases x^* units of a product at a price p^* , or has no possibility to purchase the product.

Let's now have a look at a cost function of a monopoly:

$$n(x) = nv(x) + n_F \quad (1)$$

while

$n(x): R \rightarrow R$ – continuous and differentiable total cost function,

$nv(x): R \rightarrow R$ – continuous and differentiable variable cost function,

n_F – fixed costs.

Assuming that total costs only account for monopoly's variable costs and we abstract from fixed costs, cost function of a monopoly is:

$$n(x) = nv(x)$$

Profit function of a monopoly as a difference between its revenue and costs would then be:

$$\pi(x) = px - n(x) \tag{2}$$

or

$$\pi(r, x) = r - n(x) \tag{3}$$

So a monopoly identifies an optimal, profit maximizing, combination of total revenues and supply (r^*, x^*) based on a solution of an optimization problem in a form:

$$\pi(r, x) = r - n(x) \rightarrow \max \tag{4}$$

subject to

$$u(x) \geq r \tag{5}$$

Constraint (5) guarantees rationality of consumer's behavior, who is willing to spend r financial funds on x units of a product only in a case that his feeling of satisfaction from the purchase expressed in monetary units using utility function $u(x)$ will at least be as high as his expenses. Let us remind that r expresses not only monopoly revenue from selling its production in volume x for monopoly price p but has an important alternative intuitive interpretation. At the same time it represents consumer's willingness to spend r financial funds on purchase of supplied volume of products at a given market price.

Since a monopoly obviously expects its revenues at a level of customer's feeling of maximum satisfaction, the constraint (5) is actualized as equality and further we will analyze a monopoly profit maximization problem in a form

$$\pi(r, x) = r - n(x) \rightarrow \max \tag{6}$$

subject to

$$u(x) = r \tag{7}$$

This optimization problem of mathematical programming [Avriel, 2003] represents maximization problem on bound extremum. Let us express the problem in a standard form – as a minimization problem, while we add the conditions of non-negativity of variables:

$$-\pi(r, x) = -r + n(x) \rightarrow \min \tag{8}$$

subject to

$$u(x) = r \tag{9}$$

$$x, r \geq 0 \tag{10}$$

For optimization problem (8) ... (10) we can formulate generalized Lagrange function:

$$\mathcal{L}(r, x, \lambda) = -r + n(x) - \lambda(u(x) - r) \tag{11}$$

Kuhn – Tucker optimality conditions for Lagrange function (11) are:

$$\begin{aligned} \frac{\partial \mathcal{L}(r, x, \lambda)}{\partial x} &\geq 0 & \frac{\partial \mathcal{L}(r, x, \lambda)}{\partial r} &\geq 0 & \frac{\partial \mathcal{L}(r, x, \lambda)}{\partial \lambda} &= 0 \\ x \frac{\partial \mathcal{L}(r, x, \lambda)}{\partial x} &= 0 & r \frac{\partial \mathcal{L}(r, x, \lambda)}{\partial r} &= 0 & & \\ x &\geq 0 & r &\geq 0 & & \end{aligned} \tag{12}$$

After substituting analytical form of Lagrange function (11) we can restate Kuhn – Tucker optimality conditions [Bazaraa, 2006] of a consumer utility function maximization problem as follows:

$$n'(x) - \lambda u'(x) \geq 0 \quad (12.1) \quad -1 + \lambda \geq 0 \quad (12.4) \quad u(x) - r = 0 \quad (12.7)$$

$$x(n'(x) - \lambda u'(x)) = 0 \quad (12.2) \quad r(-1 + \lambda) = 0 \quad (12.5)$$

$$x \geq 0 \quad (12.3) \quad r \geq 0 \quad (12.6)$$

We can see that if a monopoly has an interest to enforce such an optimal combination of price and supply of its production, represented by revenue and supply vector (r^*, x^*) , which would maximize its profit $\pi(r, x) = r - n(x)$, there must exist a Lagrange multiplier λ^* , for which a Kuhn – Tucker optimality conditions (11) are met – meaning that a variables vector (x^*, r^*, λ^*) is a solution to the system of equations and inequalities (12.1),..., (12.7).

Let us now have a closer look at Kuhn –Tucker optimality conditions (12) for a monopoly profit maximization problem in the conditions of an optimal combination of price-differentiated product supply and price. Assuming that a monopoly supplies positive volume of product with a differentiated price $x^* > 0$, its optimum revenues will also be positive and $r^* = px^* > 0$. From positive optimal revenue and validity of optimality condition (12.5) results an optimal value of Lagrange multiplier $\lambda^* = 1$. But if $\lambda^* = 1$, then for optimal positive value of monopoly production $x^* > 0$ and concurrent validity of optimality condition (12.2) following relations are valid

$$x^*(n'(x) - \lambda^*u'(x^*)) = 0 \wedge x^* > 0 \Rightarrow n'(x) - \lambda^*u'(x^*) = 0 \quad (13)$$

$$n'(x) - \lambda^*u'(x^*) = 0 \wedge \lambda^* = 1 \Rightarrow$$

$$u'(x^*) = n'(x) \quad (14)$$

Relation (14) confirms a very important fact, namely that a monopoly supplies such an optimal production volume x^* , for which marginal utility equals marginal production costs.

Let us now analyze one specific situation of monopoly cost structure. Let's assume that fixed costs continue to be zero while variable costs are linear, so the cost function is $n(x) = cx$, resulting in marginal costs to be constant and equal unitary variable costs c of the monopoly production, while

$$\frac{dn(x)}{dx} = \frac{d(cx)}{dx} = c$$

Relation (14) can be then expressed as:

$$u'(x^*) = c \quad (15)$$

So the relation (14) in the end represents an inverse function of monopoly supply and supply function can be expressed in a form:

$$x = (u')^{-1}(c) = s(c) \quad (16)$$

So supply is a function of monopoly costs, which is of course logical and it confirms a connection between producer's technological level and his supply. Deciding an optimal combination of price and supply a monopoly chooses pareto-optimal solution – marginal willingness of consumers to purchase supplied volume of products corresponds with monopoly

marginal costs. In other words a monopoly accepts a state that it can only better its market position if a consumer's situation gets worse. Nevertheless, a producer is in a situation when he takes an advantage of all the pareto-optimal volume of supply so he reaches maximum profit

$$\max \pi(r^*, x^*) = r^* - n(x^*) \geq 0$$

while a consumer seemingly doesn't consume at all – his feeling of utility is fully “eliminated” by his expenses

$$u(x^*) - r^* = 0$$

Let us now examine a hypothetical situation when a monopoly supplies the same volume on this market which he could have supplied on a market of perfect competition. As a matter of fact, on the market of perfect competition a supplier produces exactly the amount that makes price and marginal costs as well as supply and demand consistent. The concurrence of these two conditions results in

$$p(x) = c \quad (17)$$

which exactly matches the condition (15), from which a relation (16) for supply inverse function was derived. Naturally, in this hypothetical case the benefits of sale in a competitive equilibrium are divided totally differently. A consumer reaches non-negative utility

$$u(x^*) - cx^* \geq 0$$

and on the other hand a company reaches no profit, as

$$\pi(r^*, x^*) = r^* - n(x^*) = p(x^*)x^* - cx^* = cx^* - cx^* = 0.$$

Another theoretical, yet interesting, concept of monopoly price differentiation is application of such a price scheme when a monopoly could sell each unit of goods at an individual price. In this case a monopoly divides its supply to n parts Δx so that $x=n\Delta x$. Then a consumer expresses his willingness to purchase this product when purchasing its first unit Δx at a price p_1 in result that his utility is raised based on

$$u(0) + m = u(\Delta x) + m - p_1$$

or

$$u(0) = u(\Delta x) - p_1$$

Analogically we can express a willingness of a consumer to pay for additional unit of a product at a price p_2 by an equation

$$u(\Delta x) = u(2\Delta x) - p_2$$

This way we define the whole process of a purchase of $x=n\Delta x$ units of a product by following system of equations

$$\begin{aligned} u(0) &= u(\Delta x) - p_1 \\ u(\Delta x) &= u(2\Delta x) - p_2 \\ u(2\Delta x) &= u(3\Delta x) - p_3 \\ &\vdots \\ &\vdots \\ u((n-2)\Delta x) &= u((n-1)\Delta x) - p_{n-1} \\ u((n-1)\Delta x) &= u(x) - p_n \end{aligned} \quad (18)$$

If an individual equations from (17) are added and we assume that when purchasing zero volume a consumer feels zero utility, and $u(0) = 0$, then $u(i\Delta x)$ for $i=1, 2, \dots, n-1$ on the left and right side of an equation are compensated and we get

$$\sum_{i=1}^n p_i = u(x)$$

Based on (15) and (17), this relation can be expressed:

$$\sum_{i=1}^n u'(i\Delta x) = u(x) \quad (18)$$

From (18) we can see that a sum of marginal utilities of a partial supplies of a product with differentiated price must correspond with total utility of the whole supply volume. Regarding this fact, let us just remind that a marginal utility of a last unit purchase expressed in monetary units at the same time represents willingness of a consumer to pay for a product a price corresponding with this marginal utility. In other words, at the end it is not relevant how a monopoly discriminates the consumers. It doesn't matter whether it applies an "all or nothing" rule or whether an individual units of production are sold at a differentiated prices corresponding to marginal willingness of a consumer to buy this unit of a product.

CONCLUSION

Based on the formalized analytical tools we showed that if a producer has enough market power to not only accept the market price but to be able to significantly influence and create it, he can quite effectively use his knowledge of consumer behavior to optimize a combination of supply and price of his product. As a matter of fact, it is a rational use of the information complex about the behavior of a consumer with specifically structured market basket, where they separately analyze consumer's utility regarding purchase of optimal volume of a price-differentiated product and this utility is represented in monetary units. Other goods in the market basket are being studied without any further specification of their volumes or range as one "aggregated good" and utility regarding purchase of these other goods is represented in monetary units as a simple sum of expenses spent on the purchase.

Significant is a fact that a company with a substantial market position in order to optimize its behavior at determining a combination of supply and differentiated price of a product, derives from a thorough analysis of consumers behavior while using analytical tools – demand functions and utility functions.

A mathematical programming problem which maximizes utility function of a consumer at budgetary restraints was examined in this article as it is a relevant tool for consumer behavior analysis. We showed that Kuhn-Tucker optimality conditions formulated for this optimization problem confirm the validity of consumer decision making schemes at optimization of his demand in the conditions of differentiated prices.

In a similar way we examined a monopoly profit maximization problem in the conditions of differentiated prices and we showed the fundamental schemes of price differentiation which monopoly can effectively use as a result of its market position to maximize its revenues as well as its profits from selling the products with differentiated price.

REFERENCES

- [1] Avriel, M. (2003) *Nonlinear Programming: Analysis and Methods*, New York: Dover publications.
- [2] Bazaraa, M. and Shetty, C.M. (2006) *Nonlinear Programming: Theory and Algorithms*, 3rd edition, New York: Wiley-Interscience.
- [3] Blum, U., Müller, S. and Weiske von Gabler, A. (2006) *Angewandte Industrieökonomik: Theorien – Modelle – Anwendungen*, Berlin: Gabler Verlag.
- [4] Carlton, D.W. and Perloff, J. M. (2005) *Modern Industrial Organization*, Boston: Addison Wesley.
- [5] Fendekova, E. and Fendek, M. (2012) ‘Podmienky optimálnosti Kuhna-Tuckera v modeloch rovnováhy trhu sieťových odvetví’, *Politická ekonomie*, vol. 60, no. 6, pp. 801-821.
- [6] Fendekova, E. and Fendek, M. (2010) ‘Modely cenovej regulácie sieťových odvetví’, *Ekonomický časopis*, vol. 58, no. 10, pp. 1039-1054.
- [7] Fendek, M. (2006) ‘Modelling of reasonable profit in regulated industries’, *Quantitative Methods in Economics: Multiple Criteria Decision Making XIII – Conference Proceedings*, The Slovak Society for Operations Research Conference, Bratislava, pp. 16-24.
- [8] Fendeková, E. and Fendek, M. (2009) ‘Models of regulation of network industries in Slovakia’, *International journal of economics and business research*, vol. 1, no. 4, pp. 479-495.
- [9] Martin, S. (1996) *Advanced Industrial Economics*, Cambridge: Blackwell.
- [10] O'Sullivan, A., Sheffrin, S. and Perez P. (2006) *Microeconomics: Principles, Applications, and Tools*, 5th edition, New York: Prentice Hall.
- [11] Pepall, L., Richards, D. and Norman, D. (2008) *Industrial Organization: Contemporary Theory and Empirical Applications*, 4th edition, New York: Wiley-Blackwell.
- [12] Waldman, D. E. and Jensen, E. J. (2006) *Industrial Organization: Theory and Practice*, 3rd edition, New York: Addison Wesley.

Contact address

Prof. Ing. Michal Fendek, PhD.
Department of Operations Research and Econometrics
Faculty of Economic Informatics
University of Economics in Bratislava
Dolnozemska 1
852 35 Bratislava, Slovakia
Tel: 00421 2 67295 736
Email: fendek@dec.euba.sk

THE PANDEMIC PERIOD LENGTH MODELLED THROUGH QUEUE SYSTEMS

Manuel Alberto M. Ferreira
Instituto Universitário de Lisboa (ISCTE-IUL), Portugal

Abstract

Despite the huge progress in infectious diseases control worldwide, still epidemics happen, being the annual influenza outbreaks examples of those occurrences. To have a forecast for the epidemic period length is very important because, in this period, it is necessary to strengthen the health care. With more reason, this happens with the pandemic period, since the pandemic is an epidemic with a great population and geographical dissemination. Predominantly using results on the $M|G|\infty$ queue busy period, it is presented an application of this queue system to the pandemic period's parameters and distribution function study. The choice of the $M|G|\infty$ queue for this model is adequate, with great probability, since the greatest is the number of contagions the greatest the possibility of the hypothesis that they occur according to a Poisson process.

Keywords: $M|G|\infty$, busy period, pandemic

JEL Classification: C18

AMS Classification: 60G99

1 RISING THE MODEL

In the $M|G|\infty$ queue system

- The customers arrive according to a Poisson process at rate λ
- Receive a service which time length is a positive random variable with distribution function $G(\cdot)$ and mean α
- When they arrive, each one finds immediately an available server
- Each customer service is independent from the other customers' services and from the arrivals process
- The traffic intensity is $\rho = \lambda\alpha$.

A pandemic is an epidemic of infectious disease that is spreading through human populations across a large region¹.

So it is easy to understand how the $M|G|\infty$ queue can be applied to the pandemic period study, owing to this system suitability to deal with every kind of large populations². Then

- The parameter λ is the rate at which people is infected, supposed that the infections occur according to a Poisson process
- The service time is the time throughout which an infected person stays sick.

In a queue system a busy period is a period that begins when a customer arrives at the system finding it empty, ends when a customer abandons the system letting it empty and in it there is always at least one customer present. So in a queuing system there is a sequence of idle and busy periods.

In the $M|G|\infty$ queue system the idle periods have an exponential time length with mean λ^{-1} , as it happens with any queue system with Poisson arrivals.

¹For instance a continent, or even worldwide, see [15].

²For more examples of the $M|G|\infty$ queue practical applications, see, for instance, [3], [5], [9 – 12] and [14].

Although the busy period's distribution is much more complicated it is possible to present some results as it will be seen.

For what interests in this work

- A busy period is a pandemic period
- An idle period is a period free of the disease.

The results that will be presented are on pandemic period's length and their number in a certain time interval.

2 THE PANDEMIC PERIOD LENGTH

Call PP the random variable pandemic period length. According to the results known for the $M|G|\infty$ queue busy period length distribution

$$E[PP] = \frac{e^{\rho} - 1}{\lambda} \quad (2.1)$$

whichever is an infected person sickness time length distribution, see [14]

- As for $Var[PP]$, it depends on the whole sickness time length distribution probabilistic structure. But Sathe, see [13], demonstrated that

$$\lambda^{-2} \max[e^{2\rho} + e^{\rho} \rho^2 \gamma_s^2 - 2\rho e^{\rho} - 1; 0] \leq Var[PP] \leq \lambda^{-2} [2e^{\rho} (\gamma_s^2 + 1)(e^{\rho} - 1 - \rho) - (e^{\rho} - 1)^2] \quad (2.2),$$

where γ_s is the sickness time length coefficient of variation

- If an infected person sickness time length distribution function is

$$G(t) = \frac{e^{-\rho}}{(1 - e^{-\rho})e^{-\lambda t} + e^{-\rho}}, t \geq 0, \quad (2.3)$$

the PP distribution function is

$$PP(t) = 1 - (1 - e^{-\rho})e^{-e^{-\rho}\lambda t}, t \geq 0 \quad (2.4),$$

see [2]

- If the sickness time length distribution function of an infected person is such that

$$G(t) = 1 - \frac{1}{1 - e^{-\rho} + e^{-\rho + \frac{\lambda}{1 - e^{-\rho}} t}}, t \geq 0 \quad (2.5)$$

the *PP* distribution function is

$$PP(t) = 1 - e^{-(\epsilon^\rho - 1)^{-1} \lambda t}, t \geq 0 \quad (2.6),$$

see [4]³

-For α and ρ great enough (very intense infectious conditions) since $G(\cdot)$ is such that for α great enough $G(t) \cong 0, t \geq 0$,

$$PP(t) \cong 1 - e^{-\lambda \epsilon^{-\rho} t}, t \geq 0 \quad (2.7),$$

see [12].

Note:

-As for this last result, begin noting that many probability distributions fulfill the condition $G(t) \cong 0, t \geq 0$ for α great enough. The exponential distribution is one example.

-As for the meaning of α and ρ great enough, computations presented in [12] it is shown that for $\lambda = 1$, after $\rho = 10$ it is reasonable to admit (2.7) for many service time distributions.

3 PANDEMIC PERIODS OCURENCE IN A TIME INTERVAL

After the renewal processes theory, see [1], calling $R(t)$ the mean number of pandemic periods that begin in $[0, t]$, being $t = 0$ the beginning instant of a pandemic period, it is possible to obtain, see [6,7],

$$R(t) = e^{-\lambda \int_0^t [1-G(v)] dv} + \lambda \int_0^t e^{-\lambda \int_0^u [1-G(v)] dv} du \quad (3.1)$$

and, consequently,

$$e^{-\rho}(1 + \lambda t) \leq R(t) \leq 1 + \lambda t \quad (3.2),$$

see [6].

Also,

$$A) G(t) = \frac{\epsilon^{-\rho}}{(1-\epsilon^{-\rho})e^{-\lambda t} + \epsilon^{-\rho}}, t \geq 0$$

³Expressions (2.3) and (2.5) result from, see [8],

$$G(t) = 1 - \frac{1}{\lambda} \frac{(1 - e^{-\rho}) e^{-\lambda t - \int_0^t \beta(u) du}}{\int_0^\infty e^{-\lambda w - \int_0^w \beta(u) du} dw - (1 - e^{-\rho}) \int_0^t e^{-\lambda w - \int_0^w \beta(u) du} dw}, t \geq 0, -\lambda \leq \frac{\int_0^t \beta(u) du}{t} \leq \frac{\lambda}{\epsilon^\rho - 1},$$

making $\beta(t) = \beta$ (constant), being $\beta=0$ for (2.3) and $\beta = \frac{\lambda}{\epsilon^\rho - 1}$ for (2.5). For this collection of service time distributions, with β constant, the $M|G|\infty$ queue busy period length is exponentially distributed with an atom at the origin as (2.4). For $\beta = -\lambda$ it is purely deterministic. And, for $\beta = \frac{\lambda}{\epsilon^\rho - 1}$, it is purely exponential as (2.6). So, this collection of service time distributions gives more situations in which it is possible to have friendly distributions for the $M|G|\infty$ queue busy period length and , in addition, for *PP*.

$$R(t) = 1 + \lambda e^{-\rho t} \quad (3.3)$$

$$B) \quad G(t) = 1 - \frac{1}{1 - e^{-\rho} + e^{-\rho} + \frac{\lambda}{1 - e^{-\rho} t}}, t \geq 0$$

$$R(t) = e^{-\rho} + (1 - e^{-\rho})^2 + \lambda e^{-\rho} t + e^{-\rho} (1 - e^{-\rho}) e^{-\frac{\lambda}{1 - e^{-\rho} t}} \quad (3.4)$$

$$C) \quad G(t) = \begin{cases} 0, & t < \alpha \\ 1, & t \geq \alpha \end{cases}$$

$$R(t) = \begin{cases} 1, & t < \alpha \\ 1 + \lambda e^{-\rho} (t - \alpha), & t \geq \alpha \end{cases} \quad (3.5)$$

D) If the sickness time length is exponentially distributed

$$e^{-\rho \left(1 - e^{-\frac{t}{\alpha}}\right)} + \lambda e^{-\rho} t \leq R(t) \leq e^{-\rho \left(1 - e^{-\frac{t}{\alpha}}\right)} + \lambda t \quad (3.6)$$

4 CONCLUSIONS

So that this model can be applied it is necessary that the infections occur according to a Poisson process at constant rate. It is a hypothesis perfectly admissible in this kind of phenomena, since they have great geographic spread, even worldwide. Among the results presented, (2.1), (2.2), (2.7) and (3.2) are remarkable for the easiness and also for requiring only the knowledge of the infectious rate λ , the mean sickness time α , and the sickness time variance. The other results are more complex and demand the goodness of fit test for the distributions indicated to the sickness times.

References

- [1] Çinlar, E. (1975) *Introduction to stochastic processes*, New Jersey: Prentice Hall Inc..
- [2] Ferreira, M. A. M. (1991) 'Um sistema M|G| ∞ com período de ocupação exponencial', *Actas das XV Jornadas Luso-Espanholas de Matemática*, Évora, pp. D63-D66.
- [3] Ferreira, M. A. M. (1995) 'Aplicação do sistema M|G| ∞ ao estudo do desemprego numa certa actividade', *Revista Portuguesa de Gestão*, vol. 4, pp. 49-51.
- [4] Ferreira, M. A. M. (1995) *Comportamento transeunte e período de ocupação de sistemas de filas de espera sem espera*. PhD Thesis. ISCTE.
- [5] Ferreira, M. A. M. (2003) 'A two echelons repair system modelled through infinite servers queues', *Mathematical Methods in Economics 2003 – Conference Proceedings, The Czech Society for Operations Research Conference*, Prague, pp. 75-80.
- [6] Ferreira, M. A. M. (2004) 'M|G| ∞ queue busy cycle renewal function for some particular service time distributions', *Quantitative Methods in Economics: Multiple Criteria Decision Making XII – Conference Proceedings*, The Slovak Society for Operations Research Conference, Virt, pp. 42-47.

- [7] Ferreira, M. A. M. (2005) ‘Differential equations important in the $M|G|_{\infty}$ queue system transient behaviour and busy period’, *APLIMAT 2005 – Conference Proceedings*, 4th International Conference on Applied Mathematics, Bratislava, pp. 119-132.
- [8] Ferreira, M. A. M. and Andrade, M. (2009) ‘The ties between the $M|G|_{\infty}$ queue system transient behaviour and the busy period’, *International Journal of Academic Research*, vol. 1, pp. 84-92.
- [9] Ferreira, M. A. M., Andrade, M. and Filipe, J. A. (2012) ‘Studying pensions funds through an infinite servers nodes network: a theoretical problem’, *Journal of Physics Conference Series*, vol. 394.
- [10] Ferreira, M. A. M., Filipe, J. A. and Coelho, M. (2014) ‘Unemployment modelled through $M|G|_{\infty}$ systems’, *International Journal of Latest Trends in Finance and Economic Sciences*, vol. 4, no. 1, pp. 677-679.
- [11] Ferreira, M. A. M., Filipe, J. A., Coelho, M. and Andrade, M. (2008) ‘An infinite servers model for motor vehicles dismantling and recycling in a scarce energy ambience’, *Quantitative Methods in Economics: Multiple Criteria Decision Making XIV – Conference Proceedings*, The Slovak Society for Operations Research Conference, High Tatras, pp. 178-186.
- [12] Ramalhoto, M. F. and Ferreira, M. A. M. (1996) ‘Some further properties of the busy period of an $M|G|_{\infty}$ queue’, *Central European Journal for Operations Research and Economics*, vol. 4, no. 4, pp. 251–278.
- [13] Sathe, Y. S. (1985) ‘Improved bounds for the variance of the busy period of an $M|G|_{\infty}$ queue’, *Advances in Applied Probability*, vol. 17, no. 4, pp. 913-914.
- [14] Takács, L. (1962) *An introduction to queueing theory*, Oxford: Oxford University Press.
- [15] Pandemic [Online], Available: <http://en.wikipedia.org/wiki/Pandemic> [05 Apr 2014].

Author’s address

Professor Catedrático Manuel Alberto M. Ferreira
Instituto Universitário de Lisboa (ISCTE-IUL), Escola de Tecnologias e Arquitectura (ISTA),
Departamento de Matemática
Av. das Forças Armadas, 1649-026 Lisboa
Portugal
Email: manuel.ferreira@iscte.pt

MODELING FRAMERWORK FOR DYNAMIC PRICING AND RESOURCE ALLOCATION IN NETWORKS

*Petr Fiala,
University of Economics, Prague*

Abstract

The paper wants to contribute to the development of theories that could promote further progress in the field of dynamic pricing and allocation of resources in networks. The proposed modeling framework captures the essential features of models, such as multiple agents, multiple criteria in network, dynamic and uncertainty environment. New models and methods will combine the features of these approaches.

Keywords: multiple agents, multiple criteria, networks, dynamics, uncertainty

JEL Classification: C61

AMS Classification: 90C05, 62J99

1. INTRODUCTION

The efficient allocation of resources to production and consumption processes by a price controlled mechanism has always been the central focus of economic research. The dynamic pricing and optimal allocation of resources is traditionally one of the most fundamental topics in economics as well as in the design and implementation of production processes. What is new about pricing and resource allocation is not the management decisions themselves but rather how these decisions are made. The true innovation lies in the method of decision making.

The project wants to contribute to the development of theories that could promote further progress in the field of dynamic pricing and allocation of resources (DPRA) in networks. New approaches for networked environment will be developed with using of operations research models and methods.

The project will use operations research models and methods:

- Network analysis
- Supply chain (network) management
- Demand chain (network) management
- Game theory
- Negotiation models
- Revenue management
- Auction models
- Multi-criteria analysis
- Data envelopment analysis

The project is devoted to modeling and analyses of these dynamic processes in networks. Today network systems provide the infrastructure and foundation for the functioning of economies and societies. They come in many forms and include physical networks such as: supply and demand networks, communication networks, networks of projects, energy networks, etc. The study of networks is not limited to only physical networks where nodes coincide with locations in space but applies also to abstract networks.

2. MODELING FRAMERWORK

Concepts and methodical approaches used in the project are based on operations research. In the process of the project are specifically included the following stages:

1. Combination of supply chain and demand chain management concepts.
2. Concept modification for the conditions of the network environment.

3. Classification and identification of similarities and differences in approaches.
4. Creating a modeling framework.
5. Designing new models and methods.
6. Evaluation of performance.

Supply and demand chain management is about matching supply and demand with inventory management. Some specific features, such as information sharing in chains, can help to reach equilibrium.

Networks are today a very often used organization structure. Modifications of concept for conditions of the network environment can use principles of network economics and formal network analyses.

Instruments of games, negotiations, revenue management, auctions are used in the project.

Classification and identification of similarities and differences in approaches can help to design a modeling framework and to combine features of the approaches.

The proposed modeling framework should capture the essential features of models, such as:

- multiple agents,
- multiple criteria,
- network environment,
- dynamic environment,
- uncertainty environment,

To capture all features in one instrument is a very difficult task. The task is to prepare a set of models, methods and software for analyzing the specified features. New models and methods will combine the features of approaches; among these include e.g. network auctions, network revenue management, network allocation games, and others. Some instruments in the proposed modeling framework are described in next sections.

3. MULTIPLE AGENTS

Traditional cooperative and non-cooperative models of game theory (Kreps, 1991) and negotiation models (Raiffa, 1982) are applied. A software Matrix Game Solver was developed for solving standard models of matrix games. Negotiation models based on utility theory and negotiation under pressure were studied.

The network resource allocation problem was formulated (Fiala, 2013a). The problem considers a situation where a number of agents are connected in some network relationship. In the considered problem the network consists of a set of m links, each with capacity $c_i > 0$, $i = 1, 2, \dots, m$. The state of the network is described by a vector $\mathbf{c} = (c_1, c_2, \dots, c_m)$ of resource capacities. There are n flows (transmissions), defined by a routing matrix $\mathbf{A} = [a_{ij}]$, $i = 1, 2, \dots, m, j = 1, 2, \dots, n$, where

$$a_{ij} = 1, \text{ if flow } j \text{ traverses link } i, \text{ and} \\ a_{ij} = 0, \text{ otherwise.}$$

The decision vector $\mathbf{x} = (x_1, x_2, \dots, x_n)$ represent partitioned allocation of capacity for each of the m flows. Each flow j is characterized by the transmission rate $x_j \geq 0$, and an associated utility measure $u_j(x_j)$, which is assumed to be strictly increasing concave and twice-differentiable function of transmission rate.

The network resource allocation problem is formulated as follows:

$$u(\mathbf{x}) = \sum_{j=1}^n u_j(x_j) \tag{1}$$

subject to

$$\mathbf{Ax} \leq \mathbf{c}, \tag{2}$$

$$\mathbf{x} \geq \mathbf{0}, \tag{3}$$

The interaction between concurrent decision-making agents can be modeled as a network game. Approaches for searching Nash equilibrium are studied.

4. MULTIPLE CRITERIA

Many of real decision making problems are evaluated by multiple criteria. The universal multicriteria decision support system IZAR was developed (Kalčevová, Fiala, 2006). The main component of the system IZAR is an expert system helping the user with choosing the method most suitable for available information about the problem. IZAR not only suggests the most suitable method but also applies it immediately to the problem solving. By means of properly specified questions the expert system selects the right procedure for solving the problem, when it takes into account its peculiarities regarding entries and additional information, which user can assign to the system. An appropriate classification of multicriteria models and methods is needed because of universality of the system. The system solves discrete and continuous problems. Basic models for multiattribute evaluation and multi-objective optimization problems are included. Methods for multiattribute evaluation problems are classified by types of preference information and by calculation principles. Preference information is given as aspiration levels, ordinal information, and cardinal information. Basic calculation principles are utility maximization, minimization of a distance from the ideal alternative, and evaluation by preference relation. Methods for multiobjective optimization problems are classified by means of setting user information, as a priori information, a posteriori information, and progressive information.

5. NETWORK ENVIROMENT

The network economy is a term for today's global relationship among economic subjects characterized by massive connectivity. The analysis of possible effects of network economy is an opportune topic for challenging scientific research (Fiala, 2006). The traditional formal network analyses instruments as optimal paths and flows in networks can be used (Ahuja et al., 1993). There are some instruments that combine other features of the framework.

A hybrid procedure for network multi-criteria systems is proposed (Fiala, 2013b). The procedure is based on a combination of DEMATEL, ANP, and PROMETHEE approaches. DEMATEL is a comprehensive method for building and analyzing a structural model involving causal relationships between complex factors (Gabus and Fontela, 1972). Analytic Network Process combines network and uncertainty environment with multiple criteria and multiple agents (Saaty, 1996). The ANP makes possible to deal systematically with all kinds of dependence and feedback in the system. We used the ANP software Super Decisions developed by Creative Decisions Foundation (CDF) for some experiments for testing the possibilities of the expression and evaluation of the analyzed models. PROMETHEE methods are method for multi-criteria evaluation of alternatives, based on preference relations between alternatives, which may be expressed as a network (Brans and Mareschal, 2005). These methods have specific advantages in analyzing and evaluating network systems. The combination of these approaches gives a powerful instrument for analyzing network systems by multiple criteria.

The structure of the hybrid procedure for network multi-criteria systems can be as follows:

Step 1. Using of DEMATEL - to clarify initial relations of elements in the network system.

Step 2. Using step 1 of ANP - to form a supermatrix by pairwise comparisons.

Step 3. Using step 4 of DEMATEL and step 2 of ANP - the weighted supermatrix is obtained by multiplying the total-influence matrix (DEMATEL) with supermatrix (ANP) method.

Step 4. Using step 3 of ANP – to get the limited supermatrix with weighs.

Step 5. Using of PROMETHEE – evaluation of flows between alternatives with weights from the limited supermatrix (ANP).

6. DYNAMIC ENVIROMENT

Traditional dynamic models with continuous or discrete time can be used to capture the dynamic environment for the analyzed problems. We propose to use software system STELLA (Ruth and Hannon, 1997). The STELLA software is one of several computer applications created to implement concepts of system dynamics. It combines together the strengths of an iconographic programming style and the speed and versatility of computers. The instrument is very appropriate to proposed modeling framework.

The STELLA language consists of four basic building and one space-saving tool. The four building blocks are:

- Stock- represents something that accumulates.
- Flow- activity that changes magnitude of stock.
- Converter - modifies an activity.
- Connector - transmits inputs and information.

The approach enables to model and to solve a broad class of dynamic problems. Differential equation can be used for modelling of system dynamics. STELLA software offers the numerical techniques (Eller's method, Runge-Kutta-2 and Runge-Kutta-4 methods) to solve the model equations.

For the prediction of time-dependent priorities ANP method we propose a hybrid procedure that combines the benefits of long-term forecasting of pairwise comparisons and short-term predictions using exponential smoothing compositional data. This procedure also mutually enriches both procedures obtaining more accurate data.

Brief summary of the hybrid procedures steps:

Step 1: Formulation of pairwise comparison functions.

Step 2: Testing and improving consistency of pairwise comparisons.

Step 3: Collection of historical data by ANP priorities over time.

Step 4: Using of compositional exponential smoothing.

Step 5: Selection of the best coefficient α, β with lowest value of error.

Step 6: Forecasting of priorities for next time periods.

Step 7: Re-formulation of pairwise comparison functions based on short-run model. Go to Step 2.

7. CONCLUSIONS

The modeling framework was applied for modeling and solving specific problems in various areas as supply chain management (Fiala, 2004), revenue management (Fiala, 2012), project management, network industries. Some software for specific problems was developed, as for example CRAB (CombinatoRial Auction Body). CRAB is a non-commercial software system for generating, solving, and testing of combinatorial auction problems (Fiala et al., 2010). The solving of specific problems provides opportunities for further extension of the modeling framework. Such work on the modeling framework will continue in the future.

Acknowledgements: The research project was supported by the grant No. 13-07350S of the Grant Agency of the Czech Republic and by Grant No. IGA F4/19/2013, Faculty of Informatics and Statistics, University of Economics, Prague.

References

- [1] Ahuja, R.K., Magnanti, T.L. and Orlin, J.B. (1993) *Network Flows*, Enlewood Cliffs: Prentice-Hall.
- [2] Brans, J.-P. and Mareschal, B. (2005) 'PROMETHEE Methods', in Figueira, J., Greco, S. and Ehrgott, M. (ed.) *Multiple Criteria Decision Analysis: State of the Art Surveys*, Boston: Springer, pp. 163–195.

- [3] Fiala, P. (2004) 'Coordination of supply chains by contracts', *Mathematical Methods in Economics 2004 – Conference Proceedings*, The Czech Society for Operations Research Conference, Brno, pp. 81-88.
- [4] Fiala, P. (2006) 'An ANP/DNP analysis of economic elements in today's world network economy', *Journal of Systems Science and Systems Engineering*, vol. 15, pp. 131-140.
- [5] Fiala, P., Kalčevová, J and Vraný, J. (2010) 'CRAB – CombinatoRIal Auction Body Software System', *Journal of Software Engineering and Applications*, vol. 3, pp. 718–722.
- [6] Fiala, P. (2012) 'A framework for solving network revenue management problems with customer choice behavior', *Central European Journal of Operations Research*, vol. 20, pp. 383-392.
- [7] Fiala, P. (2013a) 'Equilibrium analyses in allocation games', *Mathematical Methods in Economics 2013 – Conference Proceedings*, The Czech Society for Operations Research Conference, Jihlava, pp. 165-170.
- [8] Fiala, P. (2013b) 'A Hybrid Procedure for Network Multi-Criteria Systems', *Acta Universitatis Palackianae Olomucensis. Facultas Rerum Naturalium. Mathematica*, vol. 52, pp. 53-60.
- [9] Gabus, A. and Fontela, E. (1972) *World problems, an invitation to further thought within the framework of DEMATEL*, Geneva: Battelle Geneva Research Centre.
- [10] Kalčevová, J. and Fiala, P. (2006) 'IZAR – Multicriteria Decision Support System', *Mathematical Methods in Economics 2006 – Conference Proceedings*, The Czech Society for Operations Research Conference, Pilsen, pp. 277-282.
- [11] Kreps, D. (1991) *Game Theory and Economic Modelling*, Oxford: Oxford University Press.
- [12] Raiffa, H. (1982) *The art and science of negotiation*, Cambridge, Mass: Harvard University Press.
- [13] Ruth, M. and Hannon, B. (1997) *Modeling Dynamic Economic System*, New York: Springer.
- [14] Saaty, T. L. (1996) *Decision making with Dependence and Feedback: The Analytic Network Process*, Pittsburgh: RWS Publications.

Author's address

Prof. RNDr. Ing. Petr Fiala, CSc., MBA,
University of Economics, Department of Econometrics,
W. Churchill Sq. 4, 130 67 Prague 3
Czech Republic
Email: petr.fiala@vse.cz

ARE SLOVAK ECONOMIC FACULTIES EFFICIENT IN THEIR SCIENTIFIC ACTIVITIES? DEA APPROACH

*Andrea Furková,
University of Economics in Bratislava*

Abstract

This paper focuses on evaluation of higher education institutions (HEI) from scientific point of view. Nowadays faculties' success in area of publications and citations is very discussed and important topic in regard to international evaluation and accreditation. We apply a nonparametric benchmarking approach - DEA to evaluate scientific activities of Slovak faculties of HEI. In the analysis we employ data set covering 11 Slovak economic faculties observed over the period of 4 years.

Keywords: Efficiency measurement, Higher education institutions, ARRA assessments, Data Envelopment Analysis

JEL Classification: I23, C02

AMS Classification: 90C05, 62J99

1 INTRODUCTION

Assessment of higher education institutions and their faculties seems to become very popular and important supporting decision tool for university leaders as well as for decision policy makers. HEI assessments and rankings provided by wide range of agencies and organizations are based on different ranking systems; different indicators or metrics are used to measure higher education activities. In Slovak Republic, there are two agencies dealing with assessment and ranking of HEI: Accreditation Commission and ARRA (Academic Ranking and Rating Agency). ARRA is an independent Slovak civil association established in 2004 by former student leaders and personalities from the academic field with the objectives of assessing the quality of Slovak higher education institutions and to stimulate positive changes in Slovak higher education [4]. In our study we also decided to focus on assessment of HEI, namely we chose economic sciences (group EKONOM - Slovak economic faculties) following ARRA classification of higher education institutions and their faculties. According to ARRA, the faculties are classified into eleven field-specific groups in order to compare only faculties that have the same orientation and similar working conditions [8]. The criteria (indicators) are divided into two main groups; education and research. The criteria and evaluation methodology are defined in ARRA [8]. Annually ARRA prepares and publishes report assessing Slovak higher education institutions from overall point of view. In this paper we decide to focus on faculties' success only from scientific point of view, i.e. their success in area of publications and citations following ARRA criteria. Data Envelopment Analysis (DEA) seems to be convenient methodology for evaluation scientific activities of HEI. Applying several DEA models for measuring technical efficiency of economic faculties within the time period of 4 years we try to evaluate a quality of scientific research activities. Main goal of this paper is to point out that quantitative benchmarking approach like DEA would be a good tool for evaluation of HEI.

2 METHODOLOGY FOR ASSESMENT OF HEI

In this part of the paper we briefly present proposed methodology for assessments of higher education institutions. We have chosen DEA methodology which is based on the estimation of efficient frontier and measures the efficiencies of DMUs (Decision Making Unit) relative to the

estimated frontier. As DEA methodology is well-known and widely applied we discuss only models to be used in our analysis. With regard to our problem in the first part of our analysis we decided to use output oriented versions of CRS (constant returns to scale) and VRS (variable returns to scale) models. With technical efficiency (TE) scores in a hand, it is possible to calculate scale efficiency (SE) and the nature of returns to scale technology of units is determined by solving additional VRS models in which non-increasing returns scale (NIRS) is assumed. Next part of our analysis was focused on additive models assuming a CRS and also VRS.

DEA involves the use of linear programming methods to construct a non-parametric piece-wise surface – frontier over the data and efficiency measures are then calculate relative to this frontier. Comprehensive treatments of the methodology are available in e.g. Cooper et al. [2], Coelli et al. [1], etc. The objective of input oriented DEA models is to identify technical inefficiency (for more details about the input-oriented models and technical inefficiency see e.g. [1], [2]) as a proportional reduction in input usage, with output levels held constant. This corresponds to Farrell’s [3] input-based measure of technical inefficiency. However, it is also possible to measure technical inefficiency as a proportional increase in output production, with input levels held fixed. In many studies, analysts have tended to select input-orientated models because the input quantities appear to be the primary decision variables. In some cases, an output orientation would be more appropriate, if the units may be given a fixed quantity of resources and asked to produce as much output as possible. This is precisely our problem of evolution of scientific activities of HEI that means by given resources faculties are requested to produce as much scientific outputs as possible.

Our discussion of DEA we begin with a description of the output-oriented CCR model. Assume there are data on N inputs and M outputs for each of I DMUs. For the i -th DMU these are represented by the column vectors \mathbf{x}_i and \mathbf{q}_i , respectively. The $N \times I$ input matrix \mathbf{X} and the $M \times I$ output matrix \mathbf{Q} , represent the data for all I units. Consider the following output-oriented CCR model [1]:

$$\begin{aligned} \max_{\phi, \lambda} \quad & \phi \\ -\phi \mathbf{q}_i + \mathbf{Q}\lambda & \geq \mathbf{0} \\ \mathbf{x}_i - \mathbf{X}\lambda & \geq \mathbf{0} \\ \lambda & \geq \mathbf{0} \end{aligned} \tag{1}$$

where $1 \leq \phi \leq \infty$, and $\phi - 1$ is the proportional increase in outputs that could be achieved by the i -th unit, with the input quantities held constant and λ is a $I \times 1$ vector of constants. The value of ϕ obtained is the efficiency score for the i -th unit, a value of 1 indicating point on the frontier and hence a technically efficient unit, according to the Farrell definition [3]. The linear programming problem (1) must be solved I times, once for each unit in the sample. A value of ϕ is then obtained for each unit. We can note that $1/\phi$ defines a TE score that varies between zero and one.

The CCR model can be easily modified to account for VRS by adding to model (1) the convexity constraint $\mathbf{e}^T \lambda = 1$, where \mathbf{e} is an $I \times 1$ vector of ones. This constraint ensures that an inefficient firm in only “benchmarked” against units of a similar size [1]. The CRS assumption is appropriate when all units are operating at an optimal scale otherwise measures of TE scores are confounded by scale efficiencies. SE measures can be obtained by conducting both a CRS and a VRS models and then decomposing the TE_{CRS} scores into two components – scale inefficiency and “pure” technical inefficiency (TE_{VRS}):

$$TE_{CRS} = TE_{VRS} \times SE \tag{2}$$

The shortcoming of the SE measure is that this value does not indicate whether the unit operates in an area of increasing returns to scale (IRS) or decreasing returns to scale (DRS). Solving this problem is possible by running an additional DEA problem with non-increasing returns to scale (NIRS) assumption imposed ($\mathbf{e}^T \boldsymbol{\lambda} \geq 1$). Modified model is following:

$$\begin{aligned} \max_{\phi, \lambda} \quad & \phi \\ -\phi \mathbf{q}_i + \mathbf{Q}\boldsymbol{\lambda} \geq & \mathbf{0} \\ \mathbf{x}_i - \mathbf{X}\boldsymbol{\lambda} \geq & \mathbf{0} \\ \mathbf{e}^T \boldsymbol{\lambda} \geq & 1 \\ \boldsymbol{\lambda} \geq & \mathbf{0} \end{aligned} \tag{3}$$

The nature of SE for a particular unit can be determined by differences between TE_{NIRS} scores and TE_{VRS} . If they are unequal then IRS exist for that unit otherwise DRS apply (for more details see [1], [2]).

All models defined before are radial models. That means that they followed Farrell definition [1], [2], [3] of TE in terms of the radial reduction in inputs (input-oriented models) that is possible or radial expansion in outputs (output-oriented models) that is possible. The value of 1 of the efficiency score for the i -th unit indicating point on the frontier and hence a technically efficient unit, according to the Farrell definition. Some authors provide a more strict definition of technical efficiency which is equivalent to stating that a unit is only technically efficient if it operates on the frontier and furthermore that all associated slacks are zero (output slack - \mathbf{s}^+ and input slack - \mathbf{s}^-). DEA additive model (also called Slack Based Model) takes into account these slacks and in addition it is not necessary to make a decision about input and output orientation of the model. The model can be formulated as follows:

$$\begin{aligned} \max_{\mathbf{s}^+, \mathbf{s}^-, \lambda} \quad & \mathbf{e}^T \mathbf{s}^+ + \mathbf{e}^T \mathbf{s}^- \\ \mathbf{X}\boldsymbol{\lambda} + \mathbf{s}^- = & \mathbf{x}_i \\ \mathbf{Q}\boldsymbol{\lambda} - \mathbf{s}^+ = & \mathbf{q}_i \\ \mathbf{e}^T \boldsymbol{\lambda} \leq & \geq 1 \\ \boldsymbol{\lambda}, \mathbf{s}^-, \mathbf{s}^+ \geq & \mathbf{0} \end{aligned} \tag{4}$$

where sign of relation in condition $\mathbf{e}^T \boldsymbol{\lambda} \leq \geq 1$ could be modified according to assumption about returns to scale. Unit is ADD efficient only if all associated slacks variables are zero (for more on this issue see [1], [6]).

3 MODEL SPECIFICATION AND DATA

DEA models defined in previous part were applied in order to evaluate the scientific research activities of economic faculties through estimated levels of efficiency. Our data set consists of 11¹ Slovak economic faculties observed over a period from 2009 to 2012. All data are based on information from statistics of ARRA [8]. The output and input selection is the first step of a model construction. As our goal is to evaluate the scientific research activities, we chose as

¹

Faculty of Management, Comenius University in Bratislava (CUB); Faculty of Business Economy, University of Economics in Bratislava (UEB); Faculty of Economic Informatics, University of Economics in Bratislava (UEB); Faculty of Economics, Technical University of Košice (TUK); Faculty of Management, University of Prešov (UP); Faculty of Business, University of Economics in Bratislava (UEB); Faculty of National Economy, University of Economics in Bratislava (UEB); Faculty of Economics, Matej Bel University in Banská Bystrica (MBUBB); Faculty of Economics and Management, Slovak University of Agriculture in Nitra (SUAN); Faculty of Business Management, University of Economics in Bratislava (UEB); Faculty of Operation and Economics of Transport and Communications, University of Žilina (UZ).

output variable aggregated ARRA indicator *Publications and Citations (VV1 – VV2a)*. As inputs which would significantly influence scientific research activities were chosen aggregated ARRA indicators *Students and Teachers (SV1 – SV4)*, *PhD Studies (VV4a – VV6)* and *Grants (VV7 – VV10)* (for more details see [8]). In the first part of our analysis, output oriented versions of CRS and VRS models (1) were applied. Based on the obtained TE scores, SE scores were also calculated (2) and the nature of returns to scale technology of faculties were determined by solving additional VRS models (3) with NIRS assumption. Next, additive models assuming a CRS technology and also VRS were estimated. Due to insufficient space we present only the most important results of applied models in next section.

4 CONCLUSION

Applied models have provided individual TE and SE scores for the faculties in each year (see tab.1, tab.2, and tab.3), unfortunately it is not possible to present other interesting models' results (e.g. virtual inputs, virtual output, pears, etc.) due to insufficient space. Results listed in tab.1 and tab. 2 show us that not all faculties operated at an optimal scale and therefore the use of the CRS specification is not appropriate. The use of the VRS specification permits the calculation of TE devoid of SE effects. More strict definition of efficiency is assumed in additive model. TE values of 1 indicate fully successful faculty in scientific activities otherwise listed values express sum of slack variables that is a distance from the efficient frontier.

Tab. 1: Results of CRS MODEL / VRS MODEL /NIRS MODEL (SCALE) – 2009, 2010

Faculty	CRS MODEL / VRS MODEL /NIRS MODEL (SCALE)							
	2009				2010			
	CRS	VRS	SCALE		CRS	VRS	SCALE	
Faculty of Economics, TUK	0,994	1	0,994	IRS	1	1	1	-
Faculty of Economics and Management, SUAN	1	1	1	-	1	1	1	-
Faculty of National Economy, UEB	1	1	1	-	1	1	1	-
Faculty of Business, UEB	1	1	1	-	0,693	0,696	0,995	DRS
Faculty of Operation and Economics of Transport and Communications, UZ	0,098	0,098	1	-	0,095	0,1	0,948	DRS
Faculty of Business Economy, UEB	0,799	0,871	0,917	IRS	0,966	0,968	0,998	IRS
Faculty of Management, CUB	1	1	1	-	1	1	1	-
Faculty of Economic Informatics, UEB	1	1	1	-	0,883	0,942	0,937	IRS
Faculty of Economics, MBUBB	0,787	0,974	0,808	IRS	0,849	0,874	0,971	DRS
Faculty of Business Management, UEB	0,348	1	0,348	IRS	0,373	0,375	0,995	IRS
Faculty of Management, UP	0,391	1	0,391	IRS	0,325	1	0,325	IRS
AVERAGE	0,765	0,904	0,86		0,744	0,814	0,924	

Source: own calculations

Tab. 2: Results of CRS MODEL / VRS MODEL /NIRS MODEL (SCALE) – 2011, 2012

Faculty	CRS MODEL / VRS MODEL /NIRS MODEL (SCALE)							
	2011				2012			
	CRS	VRS	SCALE		CRS	VRS	SCALE	
Faculty of Economics, TUK	1	1	1	-	1	1	1	-
Faculty of Economics and Management, SUAN	1	1	1	-	1	1	1	-
Faculty of National Economy, UEB	0,849	0,979	0,867	DRS	0,81	0,869	0,932	DRS
Faculty of Business, UEB	0,490	0,588	0,834	DRS	0,564	0,616	0,915	IRS
Faculty of Operation and Economics of Transport and Communications, UZ	0,043	0,051	0,85	DRS	0,142	0,142	0,999	-
Faculty of Business Economy, UEB	0,753	0,874	0,862	DRS	0,869	1	0,869	IRS
Faculty of Management, CUB	1	1	1	-	0,979	1	0,979	IRS
Faculty of Economic Informatics, UEB	1	1	1	-	1	1	1	-
Faculty of Economics, MBUBB	0,763	1	0,763	DRS	1	1	1	-
Faculty of Business Management, UEB	0,318	0,348	0,913	DRS	0,374	0,416	0,899	IRS
Faculty of Management, UP	0,217	1	0,217	IRS	1	1	1	-
AVERAGE	0,676	0,804	0,846		0,794	0,822	0,963	

Source: own calculations

Tab. 3: Results of ADDITIVE MODEL – 2009 - 2012

Faculty	ADDITIVE MODEL							
	2009		2010		2011		2012	
	CRS	VRS	CRS	VRS	CRS	VRS	CRS	VRS
Faculty of Economics, TUK	48	1	1	1	1	1	1	1
Faculty of Economics and Management, SUAN	1	1	1	1	1	1	1	1
Faculty of National Economy, UEB	1	1	1	1	87	68	69	67
Faculty of Business, UEB	1	1	55	43	64	51	60	41
Faculty of Operation and Economics of Transport and Communications, UZ	173	103	162	105	132	96	119	79
Faculty of Business Economy, UEB	44	26	9	8	29	27	34	1
Faculty of Management, CUB	1	1	1	1	1	1	4	1
Faculty of Economic Informatics, UEB	1	1	30	21	1	1	1	1
Faculty of Economics, MBUBB	47	18	42	41	45	1	1	1
Faculty of Business Management, UEB	105	1	98	58	90	67	87	45
Faculty of Management, UP	64	1	54	1	66	1	1	1

Source: own calculations

Acknowledgements: This work was supported by the Grant Agency of Slovak Republic - VEGA, grant no. 1/0595/11 "Analysis of Business Cycles in the Economies of the Euro Area (with Regards to the Specifics of the Slovak Economy) Using Econometric and Optimization Methods".

Acknowledgements: This work was supported by the Grant Agency of Slovak Republic - VEGA, grant no. 1/0285/14 "Regional modelling of the economic growth of EU countries with concentration on spatial econometric methods"

References

- [1] Coelli, T. J., Rao Prasada, D. and Battese, G. (2005) *An Introduction to Efficiency and Productivity Analysis*, 2nd edition, New York: Springer.
- [2] Cooper, W. W., Seiford, L. M. and Tone, K. (2000) *Data Envelopment Analysis*, Boston: Kluwer Academic Publishers.
- [3] Farrell, M. J. (1957) 'The Measurement of Productive Efficiency', *Journal of the Royal Statistical Society. Series A*, vol. 120, no. 3, pp. 253-281.
- [4] Furková, A. (2013) 'An econometric approach to efficiency evaluation of higher education institutions', *Efficiency and Responsibility in Education 2013 – Conference Proceedings*, Prague, pp. 151-158.
- [5] Horvát, P., König, B. and Ostrihoň, F. (2013) 'The impact of the technological progress on the development of the Slovak economy - neoclassical approach', *Mathematical Methods in Economics 2009 – Conference Proceedings*, The Czech Society for Operations Research Conference, Jihlava, pp. 151-158.
- [6] Jablonský, J. and Dlouhý, M. (2004) *Modely hodnocení efektivnosti produkčních jednotek*, Prague: Professional Publishing.
- [7] Szomolányi, K., Lukáčiková, A., and Lukáčik, M. (2011) 'The β -convergence of the EU27 Countries', *Mathematical Methods in Economics 2011 – Conference Proceedings (part II)*, The Czech Society for Operations Research Conference, Janská Dolina, p. 287-291.
- [8] ARRA: Report Assessment of higher education institutions and their Faculties 2009, 2010, 2011, and 2012, [online], Available: <http://www.arra.sk/ranking> - 2009, 2010, 2011, 2012. [14 Mar 2013].

Author's address

Ing. Andrea Furková, PhD.

University of Economics in Bratislava, Faculty of Economic Informatics, Department of Operations Research and Econometrics

Dolnozemska cesta 1, 852 35 Bratislava

Slovak Republic

e-mail: andrea.furkova@euba.sk

INVENTORY MANAGEMENT IN COURNOT DUOPOLY

*Milan Horniaček,
Comenius University in Bratislava*

Abstract

We analyze an infinite horizon symmetric Cournot duopoly producing a homogeneous good, with discounting of future single period payoffs, and management of inventories of an input in the way described by the model of dynamic lot sizing with deterministic non-stationary demand. The variable unit procurement cost depends on the total purchase of the input by both duopolists. Durability of the input equals two periods. The model has the form of a difference game. We restrict attention to pure strategy open-loop equilibria in it and consider only discount factors for which all open-loop equilibria involve alternating purchases of the input.

Keywords: Cournot duopoly, difference game, dynamic lot sizing, open loop equilibria, inventory management.

JEL Classification: C73, D43.

AMS Classification: 90C39, 91A25.

1 INTRODUCTION

Literature dealing with dynamic oligopoly models usually assumes that each firm buys all inputs in perfectly competitive markets in the period in which it uses them. Thus, the minimal expenditures on inputs needed to produce different levels of output are given by the cost function. This holds not only for infinite or finite repetition of strategic form non-cooperative oligopoly games but also (with the exception of capital inputs in the models with capital) for dynamic oligopoly models in the form of difference games. On the other hand, in operations research literature, there are models of dynamic lot sizing taking into account storing of an input for later use, in which sum of ordering, procurement and holding cost is minimized subject to satisfying demand in each period of the time horizon of the model. (See [4] Chapter 4, for description of these models.)

In the present paper, we try to unite the two approaches mentioned above. We analyze a difference game modeling an infinite horizon symmetric Cournot duopoly producing a homogeneous good, with discounting of future net cash flows, and decisions on procurement of an input taking into account ordering, procurement, and holding cost. (In order to keep the model as simple as possible, we concentrate on one input.) Durability of the input equals two periods. (This is again a simplifying assumption made in order to keep the model as simple as possible.) That is, if it is produced and bought in period t , it can be used only in period t or period $t + 1$. Unit procurement cost for the input depends on the sum of its quantities purchased by duopolists. That is, duopolists have market power in the market for the input. We restrict attention to open-loop equilibria (i.e. equilibria in which players' actions depend only on the number of a period, not on a history leading to it) and consider only discount factors for which all open-loop equilibria involve alternating purchases of the input (in odd periods by one firm and in even periods by the other firm).

2 MODEL

We denote by N the set of positive integers, by N_1 the set of odd positive integers, by N_2 the set of even positive integers, and by \mathfrak{R} the set of real numbers. For each $n \in N$, we endow \mathfrak{R}^n with the Euclidean topology and \mathfrak{R}^∞ with the product topology. The apostrophe denotes a derivative.

Time horizon of the model is N . There are two identical Cournot duopolists producing a homogeneous good. The inverse demand function, $P: [0, \infty) \rightarrow [0, P(0)]$, assigns to each sum of duopolists' outputs Q the unit price $P(Q)$ of the good. It has the following properties: (i) it is continuous, (ii) there exists $\bar{Q} > 0$ such that $P(Q) > 0$ for each $Q \in [0, \bar{Q})$ and $P(Q) = 0$ for each $Q \geq \bar{Q}$, (iii) it is twice continuously differentiable, strictly decreasing, and concave on $[0, \bar{Q})$.

In each period, ordering cost for the input is $K > 0$, unit holding cost is $h > 0$, and unit procurement cost is expressed by function $C: [0, \infty) \rightarrow [0, \infty)$. When the quantities of the input purchased by duopolists are x_1 and x_2 , the unit procurement cost is $C(x_1 + x_2)$. Function C is twice continuously differentiable, strictly increasing, and convex.

For each duopolist, production function $f: [0, \infty) \rightarrow [0, \infty)$ assigns to each used quantity x of the input the maximal output $f(x)$ that can be produced from it. Function f is (i) twice continuously differentiable, (ii) strictly increasing, (iii) strictly concave, and (iv) it satisfies $f(0) = 0$.

Both firms discount single period payoffs identified with single period net cash flows by discount factor $\delta \in (0, 1)$. Single period net cash flow is defined as the difference between the single period revenue from selling output and the sum of ordering, procurement, and holding cost in the period. We denote the analyzed game with discount factor δ by $\Gamma(\delta)$. It is a difference game because firms' stocks of the input at the beginning of the current period are payoff relevant (they affect single period payoffs from their purchases of the input in the current period). Average discounted single period net cash flow is the payoff of each firm in $\Gamma(\delta)$.

Let

$$z = \arg \max \{P(f(z))f(z) - C(z)z \mid z \in [0, f^{-1}(\bar{Q})]\}. \quad (1)$$

We assume that

$$(C'(4z) - C(0) + h)z < K. \quad (2)$$

It follows from (1) that there does not exist an open-loop equilibrium in which some firm in some period uses a quantity of the input equal to or exceeding z . The same holds for any of the firms acting as a monopolist. Then (2) implies (taking into account that the durability of the input equals two periods) that in each open-loop equilibrium each purchase of the input by any firm covers its use in the two consecutive periods.

3 EQUILIBRIUM WITH ALTERNATING PURCHASES

Since unit procurement cost for the input depends on its total purchase, for discount factors close to one the firms may increase their payoffs by purchasing the input in different periods. We restrict attention to discount factors for which all open-loop equilibria involve alternating purchases of the input. The lower bound on such discount factors is derived from the quantities of the input used in the Nash equilibrium on the set of open-loop strategy profiles with simultaneous purchase of the input. (The latter equilibrium can be shown to be symmetric and unique.) For such discount factors, in order to prove the existence of an open-loop equilibrium, it is enough to prove the existence of a Nash equilibrium on the set of open-loop strategy profiles with a given time schedule of alternating purchases of the input. Here we analyze the equilibrium, in which in odd periods other than one only firm 1 purchases the input and in even periods only firm 2 purchases the input. In period one firm 1 purchases the input for the use in periods one and two, while firm 2 purchases the input for the use only in the first period. Taking into account (1), we consider only used amounts of the input from the interval $[0, z]$.

Let $x_j(t)$ be the amount of the input used in period $t \in N$ by firm $j \in \{1, 2\}$. We identify sequences of used inputs with the firms' open-loop strategies. Then firm 1's payoff function $\Pi_1 : [0, z]^\infty \times [0, z]^\infty \rightarrow \mathfrak{R}$ is defined by

$$\begin{aligned} & \Pi_1(\{x_1(t)\}_{t \in N}, \{x_2(t)\}_{t \in N}) \\ &= P(f(x_1(1)) + f(x_2(1)))f(x_1(1)) - C(x_1(1) + x_2(1) + x_1(2))(x_1(1) + x_1(2)) - K \\ &+ \sum_{t \in N_1 \setminus \{1\}} \delta^{t-1} [P(f(x_1(t)) + f(x_2(t)))f(x_1(t)) - C(x_1(t) + x_2(t+1))(x_1(t) + x_2(t+1)) - hx_1(t+1) - K] \\ &+ \sum_{t \in N_2} \delta^{t-1} P(f(x_1(t)) + f(x_2(t)))f(x_1(t)) \end{aligned} \quad (3)$$

Similarly, firm 2's payoff function $\Pi_2 : [0, z]^\infty \times [0, z]^\infty \rightarrow \mathfrak{R}$ is defined by

$$\begin{aligned} & \Pi_2(\{x_1(t)\}_{t \in N}, \{x_2(t)\}_{t \in N}) \\ &= P(f(x_1(1)) + f(x_2(1)))f(x_2(1)) - C(x_1(1) + x_2(1) + x_1(2))x_2(1) - K \\ &+ \sum_{t \in N_2} \delta^{t-1} [P(f(x_1(t)) + f(x_2(t)))f(x_2(t)) - C(x_2(t) + x_2(t+1))(x_2(t) + x_2(t+1)) - hx_2(t+1) - K] \\ &+ \sum_{t \in N_1} \delta^{t-1} P(f(x_1(t)) + f(x_2(t)))f(x_2(t)) \end{aligned} \quad (4)$$

These functions are defined on nonempty compact convex subset $[0, z]^\infty \times [0, z]^\infty$ of metrizable space $\mathfrak{R}^\infty \times \mathfrak{R}^\infty$. With respect to the assumptions about functions P , C , and f , they are continuous in $(\{x_1(t)\}_{t \in N}, \{x_2(t)\}_{t \in N})$. If $(\{x_1^*(t)\}_{t \in N}, \{x_2^*(t)\}_{t \in N})$ is an open-loop equilibrium, then $\{x_1^*(t)\}_{t \in N}$ solves

$$\max \Pi_1(\{x_1(t)\}_{t \in N}, \{x_2^*(t)\}_{t \in N}) \quad \text{subject to } \{x_1(t)\}_{t \in N} \in [0, z]^\infty \quad (5)$$

and $\{x_2^*(t)\}_{t \in N}$ solves

$$\max \Pi_2(\{x_1^*(t)\}_{t \in N}, \{x_2(t)\}_{t \in N}) \quad \text{subject to } \{x_2(t)\}_{t \in N} \in [0, z]^\infty. \quad (6)$$

Moreover, each solution to (5), satisfies

$$f(x_1(t)) + f(x_2^*(t)) < \bar{Q}, \forall t \in N \quad (7)$$

and each solution to (6) satisfies

$$f(x_1^*(t)) + f(x_2(t)) < \bar{Q}, \forall t \in N. \quad (8)$$

From the first order conditions for (5) and (6) and the assumption that f is strictly increasing and strictly concave (which implies that the first derivative of f is positive on its domain) it follows that each solution to (5) satisfies

$$P(f(x_1(t)) + f(x_2^*(t))) + f(x_1)P'(f(x_1(t)) + f(x_2^*(t))) > 0, \forall t \in N \quad (9)$$

and each solution to (6) satisfies

$$P(f(x_1^*(t)) + f(x_2(t))) + f(x_2)P'(f(x_1^*(t)) + f(x_2(t))) > 0, \forall t \in N \quad (10)$$

The subset of open-loop strategies of firm 1 (firm 2) that satisfies (7) and (9) ((8) and (10)) is convex. (In the case of (7) and (8) it follows from the assumption that f is strictly increasing. In the case of (9) and (10) it follows from the fact that its left hand side is strictly decreasing in $x_1(t)$ and $x_2(t)$, respectively.) In each period, firm 1's (firm 2's) revenue is strictly concave in its use of the input on the subset of its open-loop strategies that satisfy (7) and (9) ((8) and (10)). In each odd (even) period firm 1's (firm 2's) expenditures on the input (as a function of two variables) is convex and its cost of holding inventories is linear. Thus, firm 1's (firm 2's) payoff function is strictly concave in its open-loop strategy on the subset of its open-loop strategies that satisfy (7) and (9) ((8) and (10)). This implies that maximization problems (5) and (6) have the unique solution. The latter conclusion holds for any feasible open-loop strategy of the other firm (because a strategy that prescribes the use of the input exceeding z in some period is not feasible). This, together with continuity of firms' payoff functions, implies that the mapping $g : [0, z]^\infty \times [0, z]^\infty \rightarrow [0, z]^\infty \times [0, z]^\infty$ that assigns to each pair of firms' open-loop strategies the pair of best responses is a continuous function. Its domain is a nonempty compact convex subset

of metrizable (and, hence, locally convex) space $\mathfrak{R}^\infty \times \mathfrak{R}^\infty$. Therefore, by Theorem 1 in [1], it has a fixed point. (Since the range of g equals $[0, z]^\infty \times [0, z]^\infty$, g is a special case of the mapping considered in Theorem 1 in [1].) Thus, an open-loop equilibrium with the properties described in the first paragraph of this section exists.

4 CONCLUSIONS

In the open-loop equilibrium in Section 3 (with the exception of period one) firms alternate in purchase of the input but they both produce in each period. There can be also open-loop equilibria, in which firms alternate also in production, i.e., they behave as a monopolist in an alternating way. They can either act as one-period monopolist (avoiding holding cost, but incurring fixed ordering cost in every second period) or as a two-period monopolist (incurring holding cost, as well as fixed ordering cost, in every fourth period). In both cases, such equilibrium exists only if fixed ordering cost is large enough to prevent a firm from gaining positive net cash flow from buying the input and producing in a period (or periods) in which it is not supposed to do so. In all cases considered in this paper, firms coordinate their purchases in order to decrease cost associated with obtaining of the input. Nevertheless, such coordination leads also to coordination with respect to output. Thus, it is (at least) questionable whether such coordination of outputs can be viewed as violation of competition laws.

The approach based on coordination of input purchases could be incorporated also into other models with market power of some economic agents, e.g. in analysis of behavior of large issuers of securities that could supplement traditional decomposition methods in portfolio analysis (that are used, for example, in [2] and [3]).

Acknowledgements: The research reported in this paper was supported by grant VEGA 1/0181/12.

References

- [1] Browder, F. E. (1967) ‘A new generalization of the Schauder fixed point theorem’, *Mathematische Annalen*, vol. 174, no. 4, pp. 285-290.
- [2] Mlynarovič, V. (2013) ‘Dekompozícia výnosov a rizika portfolio’, *Využitie kvantitatívnych metód vo vedecko-výskumnej činnosti a v praxi X – Conference Proceedings*, The Seminar of Department of Operations Research and Econometrics, Čingov, pp. 122-128.
- [3] Mlynarovič, V. (2013) ‘Rozvinuté schémy dekompozície výnosov portfolio’, *Nové trendy v ekonometrii a operačným výzkumu – Conference Proceedings*, The Seminar of Department of Econometrics in Prague and Department of Operations Research and Econometrics in Bratislava, Prague, pp. 138-146.
- [4] Muckstadt, J. A. and Sapra, A. (2010) *Principles of inventory management. When you are down to four, order more*, New York: Springer.

Author’s address

Doc. Ing. Milan Horniaček, CSc.
 Comenius University in Bratislava, Faculty of Social and Economic Sciences
 Institute of Economics
 Mlynské luhy 4, 821 05 Bratislava
 Slovak Republic
 email: milan.horniacek@fses.uniba.sk

ESTIMATION OF SLOVAK FISCAL POLICY MODEL USING BAYESIAN APPROACH

*Peter Horvát, Brian König, Filip Ostrihoň,
University of Economics in Bratislava*

Abstract

In the following paper a new Keynesian model is considered for the conditions of Slovak economy, which captures various tools and features of fiscal policy. Among these tools are various tax rate settings for consumption, income, capital and labour as well as government spending through subsidies and public procurement. Further the model incorporates nominal and real rigidities such as habit formation, Calvo prices and wages. The model is intended to allow analysis of the impact of the tax rate shocks on the burdened agents, by the taxes, as well as aggregate output, consumption, employment and behaviour of the government, maintaining balanced public finance. To ascertain relevance, the model is estimated by Bayesian techniques according to historical data.

Keywords: fiscal policy, estimation, Slovakia, Bayesian method, DSGE

JEL Classification: C51, C63, D58, E62

AMS Classification: 91B51, 91B64

1 INTRODUCTION

Fiscal policy as such belongs to the key competences of governmental decision making. Its outcome can in many ways affect the behaviour of other economic agents. On the other hand there are ever present restrictions of the fiscal policy, namely the state budget and the risk of public deficit, requiring policy to adjust and change. The sensitivity of particular economy to its fiscal policy is currently becoming an important issue, since European Union (EU) has recently proposed measures such as Common Consolidated Corporate Tax Base [1], which slowly moves the decision power from national governments to supra-national legislation of EU.

The paper is therefore intended to estimate the most appropriate parameterization of the new Keynesian model proposed by Iwata [4] adequate to the conditions of Slovak economy. The model is further intended for future analyses of Slovak fiscal policy and for examination of various economic agents' behaviour to the shocks in the taxation and governmental spending.

In the second section a brief theoretical description of the model is provided. Next section contains the calibration of priors, chosen as the starting point for the Bayesian estimation procedure according to historical Slovak data. Used data as well as the details of methodology and of selected settings for Bayesian estimation are presented in the section three. The fourth section is dedicated to the presentation of obtained results from the estimation and their additional analysis. The evaluation of the obtained posterior parameterization and its implications, for the Slovak economy, are stated in the fifth section. Revision of the obtained results and their relevance may be found in conclusion.

2 CHOSEN MODEL FOR THE CONDITIONS OF SLOVAKIA AND A BRIEF DESCRIPTION

For the purposes of presented paper the model described by Iwata [4] was adopted, since other considered models focus more on identification of Taylor – like rule, which is not the aim of our future analyses. The used model represents an extended variant of DSGE model developed by Smets and Wouters [6] which contains various rigidities. Following part is written according to Iwata [4].

2.1 Households

Presented model considers two types of households: Ricardian and non-Ricardian. The Ricardian household i maximizes its utility by making choice about its consumption $C_t^R(i)$, investment $I_t(i)$, government bonds $B_t(i)$, next period's capital stock $K_t(i)$ and intensity of the capital stock utilization $z_t(i)$, wherein utility function takes into accounts decisions between consumption and labour. The Ricardian household is based on a flow budget constraint in the following form:

$$(1 + \tau_t^c)C_t^R(i) + I_t(i) + \Psi(z_t(i))K_{t-1}(i) + \frac{B_{t-1}(i)}{R_t P_t} = (1 - \tau_t^d)\omega_t(i)L_t^R(i) + (1 - \tau_t^k)r_t^k z_t(i)K_{t-1}(i) + (1 - \tau_t^d)\frac{D_{t-1}(i)}{P_t} + \frac{B_{t-1}(i)}{P_t} \quad (1)$$

Where $\Psi(z_t(i))$ represents costs associated with different levels of capital utilization $z_t(i)$. $D_t(i)$ refers to dividends distributed by firms to the Ricardian household. $\tau_t^c, \tau_t^d, \tau_t^k$ represent consumption, labour and capital income tax rates, respectively. $P_t, R_t, \omega_t(i), r_t^k$ denote aggregate price level, riskless return on government bonds, real wage income and real rental rate of capital. Capital stock K_{t-1} and government bonds $B_{t-1}(i)$ at current period are expressed by using $(t-1)$ meaning that their decisions are made in previous period.

The physical capital accumulation law for the Ricardian household can be expressed as follows:

$$K_t(i) = (1 - \delta)K_{t-1}(i) + \left[1 - S\left(\frac{\varepsilon_t^i I_t(i)}{I_{t-1}(i)}\right)\right] I_t(i) \quad (2)$$

Where δ denotes depreciation rate, $S\left(\frac{\varepsilon_t^i I_t(i)}{I_{t-1}(i)}\right)$ is the adjustment cost function in investment. ε_t^i denotes a shock to investment cost function.

Using $A_t, A_t Q_t$ to denote the Lagrange multipliers, the first-order conditions with respect to $C_t^R(i), B_t(i), K_t(i), z_t(i)$ can be expressed as:

$$(1 + \tau_t^c)A_t = \varepsilon_t^k (C_t^R(i) - h C_{t-1}^R(i))^{-\sigma} \quad (3)$$

$$\beta R_t E_t \left[\frac{A_{t+1}}{A_t} \frac{P_t}{P_{t+1}} \right] = 1 \quad (4)$$

$$Q_t \left[1 - S\left(\frac{\varepsilon_t^i I_t(i)}{I_{t-1}(i)}\right) \right] - Q_t S\left(\frac{\varepsilon_t^i I_t(i)}{I_{t-1}(i)}\right) \frac{\varepsilon_t^i}{I_{t-1}(i)} I_t(i) = -\beta E_t \left[\frac{A_{t+1}}{A_t} Q_{t+1} S\left(\frac{\varepsilon_{t+1}^i I_{t+1}(i)}{I_t(i)}\right) \frac{\varepsilon_{t+1}^i I_{t+1}(i)}{I_t(i)^2} \right] + 1 \quad (5)$$

$$Q_t = \beta E_t \left[\frac{A_{t+1}}{A_t} ((1 - \delta)Q_{t+1} + (1 - \tau_{t+1}^k)r_{t+1}^k z_{t+1}(i) - \Psi(z_{t+1}(i))) \right] + \eta_t^k \quad (6)$$

$$(1 - \tau_t^k)r_t^k = \Psi(z_t(i)) \quad (7)$$

Q_t denotes the shadow price of additional unit of capital.

Characteristic feature of the non-Ricardian household j is that it is considered as non-optimizing agent, which does not have any access to financial markets. For that reason it simply consumes all its net disposal income. If we denote consumption and labour of non-Ricardian households as $C_t^{NR}(j), L_t^{NR}(j)$, respectively, the budget constraint they face can be written as follows:

$$(1 + \tau_t^c)C_t^{NR}(j) = (1 - \tau_t^d)\omega_t(j)L_t^{NR}(j) \quad (8)$$

2.2 Wage Setting

In the model it is assumed that the members of Ricardian households are able to set their wages for their differentiated labour supply $L_t^R(i)$. Calvo's staggered price setting represents key factor determining the nominal wages $W_t^R(i)$ of Ricardian households. On the contrary, non-Ricardian households set their wages $W_t^{NR}(j)$ of their differentiated labour service $L_t^{NR}(j)$ as an average of wages of Ricardian households. Since every household face the same labour demand schedule, the wages as well as the labour supplies of both types of households are the same, i.e.

$W_t^R(i) = W_t^{NR}(j) = W_t(n)$ and $L_t^R(i) = L_t^{NR}(j) = L_t(n)$. The adjustment of aggregate wage can be written as:

$$w_t = \left[(1 - \xi_w)(w_t(n))^{-\frac{1}{\lambda_{wt}}} + \xi_w \left(\left(\frac{P_{t-1}}{P_{t-2}} \right)^{\eta_w} w_{t-1}(n) \right)^{-\frac{1}{\lambda_{wt}}} \right]^{-\lambda_{wt}} \quad (9)$$

Where $(1 - \xi_w)$ represents probability that particular Ricardian household is allowed to reset its wage in optimal pattern. λ_{wt} denotes the wage markup given as $\lambda_{wt} = \lambda_w + \eta_t^w$ where η_t^w is an i.i.d. normal error.

2.3 Firms

The model considers two types of firms: perfectly competitive final-good firms, which produce the goods Y_t , and on the other hand monopolistically competitive intermediate-good firms f . The differentiated intermediate-goods $y_t(f)$ are combined and form final-goods Y_t . Particular intermediate-good firms produce output by using increasing returns to scale Cobb-Douglas technology. Cost minimization with respect to the production technology determines marginal cost in the following form:

$$mc_t = \frac{w_t^{1-\alpha} (r_t^k)^\alpha}{\varepsilon_t^\alpha (1-\alpha)^{1-\alpha} \alpha} \quad (10)$$

r_t^k is real rental cost of capital, w_t represents aggregate real wage and ε_t^α denotes a technology shock which assumes a first-order autoregressive process in the following form $\varepsilon_t^\alpha = \rho_\alpha \varepsilon_{t-1}^\alpha + \eta_t^\alpha$. The labour aggregate demand function can be given as:

$$L_t = \frac{1-\alpha}{\alpha} \frac{r_t^k}{w_t} z_t K_{t-1} \quad (11)$$

2.4 Price Setting

As was already mentioned the model assumes staggered contracts proposed by Calvo, therefore sluggish price adjustment is used. Then the aggregate price adjustment can be given as:

$$P_t = \left[(1 - \xi_p)(p_t(f))^{-\frac{1}{\lambda_{pt}}} + \xi_p \left(\left(\frac{P_{t-1}}{P_{t-2}} \right)^{\eta_p} p_{t-1}(f) \right)^{-\frac{1}{\lambda_{pt}}} \right]^{-\lambda_{pt}} \quad (12)$$

2.5 Fiscal and Monetary Policy

Fiscal authorities purchase final goods G_t , issue bonds B_t and collect following taxes: τ_t^c , τ_t^l , τ_t^k which denote consumption tax, labour income tax and capital income tax respectively. The flow budget constraint for the fiscal policy is given as follows:

$$G_t + \frac{B_{t-1}}{P_t} = \tau_t^c C_t + \tau_t^l w_t L_t + \tau_t^k r_t^k z_t K_{t-1} + \tau_t^d \frac{D_t}{P_t} + \frac{1}{R_t} \frac{B_t}{P_t} \quad (13)$$

Used model assumes that the tax rates positively respond to a debt-to-output ratio. Particular tax rates are expressed as follows:

$$\hat{\tau}_t^c = \rho_{tc} \hat{\tau}_{t-1}^c + (1 - \rho_{tc}) \phi_{tc} (\hat{b}_{t-1} - \hat{Y}_{t-1}) + \eta_{tc} \quad (14)$$

$$\hat{\tau}_t^l = \rho_{tl} \hat{\tau}_{t-1}^l + (1 - \rho_{tl}) \phi_{tl} (\hat{b}_{t-1} - \hat{Y}_{t-1}) + \eta_{tl} \quad (15)$$

$$\hat{\tau}_t^k = \rho_{tk} \hat{\tau}_{t-1}^k + (1 - \rho_{tk}) \phi_{tk} (\hat{b}_{t-1} - \hat{Y}_{t-1}) + \eta_{tk} \quad (16)$$

Where the variables with the hat denote log-deviations from steady state. $b_t \equiv B_t/P_t$ represents real government bonds. Similarly as in the previous case $\eta_{tc}, \eta_{tl}, \eta_{tk}$ denote i.i.d. normal errors. The combination of coefficients $\rho_{tc}, \rho_{tl}, \rho_{tk}, \phi_{tc}, \phi_{tl}, \phi_{tk}$, determines the reactions of particular tax on debt-to-output ratio.

Government expenditure is assumed to respond on output gap as follows:

$$\hat{G}_t = \rho_g \hat{G}_{t-1} + (1 - \rho_g) \phi_{g\pi} \hat{\pi}_{t-1} + \eta_{g\pi} \tag{17}$$

If we speak about the monetary policy it is assumed that interest rates are set in the following pattern:

$$\hat{R}_t = \rho_r \hat{R}_{t-1} + (1 - \rho_r) \phi_{r\pi} \hat{\pi}_{t-1} + (1 - \rho_r) \phi_{r\gamma} \hat{\gamma}_t + \eta_{r\pi} \tag{18}$$

where $\pi_{t-1} \equiv \log(P_{t-1}/P_{t-2})$ represents inflation rate. η_{tR} denotes i.d.d. normal error.

2.6 Aggregation and Market Clearing

Aggregate consumption of households C_t is combined by a weighted average of the consumption of Ricardian and non-Ricardian households respectively, in the following way:

$$C_t = (1 - \omega) C_t^R(i) + \omega C_t^{NR}(j) \tag{19}$$

In the similar way can be expressed aggregate labour hours L_t per capita:

$$L_t = (1 - \omega) L_t^R(i) + \omega L_t^{NR}(j) \tag{20}$$

To close the model the aggregate production equation and the final-goods market equilibrium condition have to be set. The model assumes following expressions for the mentioned variables:

$$Y_t = \varepsilon_t^Z Z_t K_{t-1}^\alpha L_t^{1-\alpha} - \Phi \tag{21}$$

$$Y_t = C_t + I_t + G_t + \Psi(z_t) K_{t-1} \tag{22}$$

3 CALIBRATION AND THE USED DATA

For the purposes of Bayesian estimation it was necessary to set prior distributions of model's parameters. Relevant parameterization for the conditions of Slovakia drawn from the work of Horvát, König and Ostrihoň, [3] for similar model [4] was used as starting point for the means of the distributions. The values were naturally adjusted for the purposes of estimation initiation. After several runs of estimation procedure (explained in the following section), final set of priors presented in the Table 1 was obtained.

Table 1: Final prior parameterization of the model for the purpose of the estimation. **Source:** Authors' calibration.

Parameters			Parameters		
Notion	Mean	Distribution	Notion	Mean	Distribution
h	0.1	Beta	ρ_{tc}	0.8	Beta
σ_c	1.9	Gamma	ϕ_{tcb}	0.1	Normal
σ_l	2	Gamma	ρ_{td}	0.8	Beta
ϕ	1.3	Gamma	ϕ_{tdb}	0.285	Gamma
φ	0.5	Gamma	ρ_{tk}	0.7	Beta
ε_w	0.78	Beta	ϕ_{tkb}	0.105	Normal
ε_p	0.82	Beta	ρ_a	0.9	Beta
γ_w	0.75	Beta	ρ_b	0.5	Beta
γ_p	0.74	Beta	ρ_l	0.8	Beta
ω	0.1	Beta	ρ_i	0.2	Beta
ρ_r	0.8	Beta	α	0.66	Beta
$\phi_{r\pi}$	1.7	Normal	β	0.98	Beta
$\phi_{r\gamma}$	0.5	Normal	δ	0.08	Beta
ρ_g	0.8	Beta	ζ	0.6	Beta
$\phi_{g\pi}$	0.112	Normal	λ_w	0.5	Beta

In order to obtain estimated values of the parameters we have used following quarterly nominal time series: private final consumption, government expenditures, investment, labour hours, wages and salaries, gross domestic products, inflation and interest rate for the time span 1999Q1-2012Q4, which corresponds to 56 observations. Trend components of the mentioned time series were removed by HP filter. Besides the data which were used in the HP filtered form, it was important to obtain derived time series. Average tax rates on the consumption, capital and labour were obtained according to Iwata [4] using time series of taxes on products (reported by general government), current taxes on income and wealth (reported by households), operating surplus (reported by households), property income (reported by households), employers social contributions (reported by households), total social contributions (reported by households), current taxes on income and wealth (reported by general government), other taxes on production (reported by general government) and operating surplus for total economy.

4 METHODOLOGY

For the purpose of the estimation of the parameters we have used Metropolis - Hastings Markov chains Monte Carlo (MH-MCMC) algorithm implemented in the software platform Dynare. The estimation procedure is composed from several estimations. In the first estimation we set the values of the priors to the values according to Horvát, König and Ostrihoň [3]. Estimated posteriors, corrected by our insight, served as the priors in the next estimation and the procedure repeated until the posterior values of all parameters are without 90% confidence interval. Final set of priors, stated in the previous section, was obtained using this procedure. For the last estimation, which results are presented in the following section, we have performed 500 000 replications of the Monte Carlo simulations.

5 RESULTS

The estimated parameters of final run of the MH-MCMC algorithm are presented in the Table 2. Due to the large number of estimated parameters we take a closer look only on some of them, which we consider crucial for description of Slovak economy. Chosen parameters are therefore more deeply analysed in the subsection 5.1.

Table 2: Estimated posterior parameters of the model through the MH-MCMC algorithm.

Parameters			Parameters		
Notion	Mean	Distribution	Notion	Mean	Distribution
h	0.0993	Beta	ρ_{tc}	0.8000	Beta
σ_c	1.9006	Gamma	ϕ_{icb}	0.1006	Normal
σ_l	2.0014	Gamma	ρ_{td}	0.7998	Beta
ϕ	1.2972	Gamma	ϕ_{tdb}	0.2854	Gamma
φ	0.4984	Gamma	ρ_{tk}	0.7000	Beta
ε_w	0.7801	Beta	ϕ_{tkb}	0.1051	Normal
ε_p	0.8244	Beta	ρ_a	0.8997	Beta
γ_w	0.7482	Beta	ρ_b	0.4991	Beta
γ_p	0.7417	Beta	ρ_l	0.7999	Beta
ω	0.1003	Beta	ρ_i	0.1993	Beta
ρ_r	0.8005	Beta	α	0.6602	Beta
$\phi_{r\pi}$	1.6999	Normal	β	0.9802	Beta
ϕ_{ry}	0.5002	Normal	δ	0.0765	Beta
ρ_g	0.8166	Beta	ζ	0.5993	Beta
ϕ_{gy}	0.1084	Normal	λ_w	0.5000	Beta

Source: Authors' computation via Dynare platform.

5.1 The Estimates of Key Parameters of Slovak Economy

Few of the estimated parameters were selected for deeper analysis. First such is the parameter β , which describes consumer's time preference. At approximate estimated value 0.98 the parameter denotes relatively high consumer's preference for current consumption, since consumption of the same good one year from now would yield only 92.3% of present utility. The value may be compared to the works of Zeman and Senaj [7], and Zeman et al. [8], which assumed for the conditions of Slovakia higher value 0.99 and 0.998 respectively. The parameter is still higher than relatively extreme value for conditions of Slovakia used by Horvát, König and Ostrihoň [2], 0.95.

Another selected parameter is α , which prior value was set according to the work of Szomolanyi, Lukáčik and Lukáčiková [5], to the value 0.66. Bayesian estimation procedure has confirmed this value, which describes the elasticity of output to the change of capital. Due to the assumption of constant returns to scale, we also know the value of elasticity of labour, which is 0.34. According to the estimated value the production technology in Slovakia is far more demanding on capital than on labour. Different assumptions for Slovak economy may be found in works of Zeman and Senaj [7], Zeman et al. [8], which set the α to the values of 0.5 and 0.3 respectively.

Another parameter chosen for a deeper analysis is the depreciation rate δ , which is estimated at value 0.0765. At this rate a stock of capital will depreciate under the 10% of its original value in less than 8 years. Estimated rate may be viewed little high compare to the values used by Zeman and Senaj [7] and Zeman et al. [8], which used 0.015 and 0.02 respectively.

The parameter of degree of habit formation h was estimated to the value 0.0993. The value allows relatively high utility, yielded from the same consumption level in two subsequent periods. Compared to the value used in works of Zeman and Senaj [7] and Zeman et al. [8], which used values 0.6 and 0.64 respectively for the conditions of Slovakia, we may see that estimated value is relatively low.

The last of more closely analysed parameters is the share of non-Ricardian households ω , estimated to the approximate value 0.1. The interpretation of the parameter is that approximately 10% of Slovak households do not have access or do not use the financial markets, and therefore consume all of their disposable income. Compare to the work of Zeman and Senaj [7] for the conditions of Slovakia, the share is relatively low since the work assumes similar parameter at value 0.5.

The prior (grey curve) and posterior (black curve) distributions of the examined parameters are presented in the following Figure 1. The commentary to the figure is stated in the section 6.

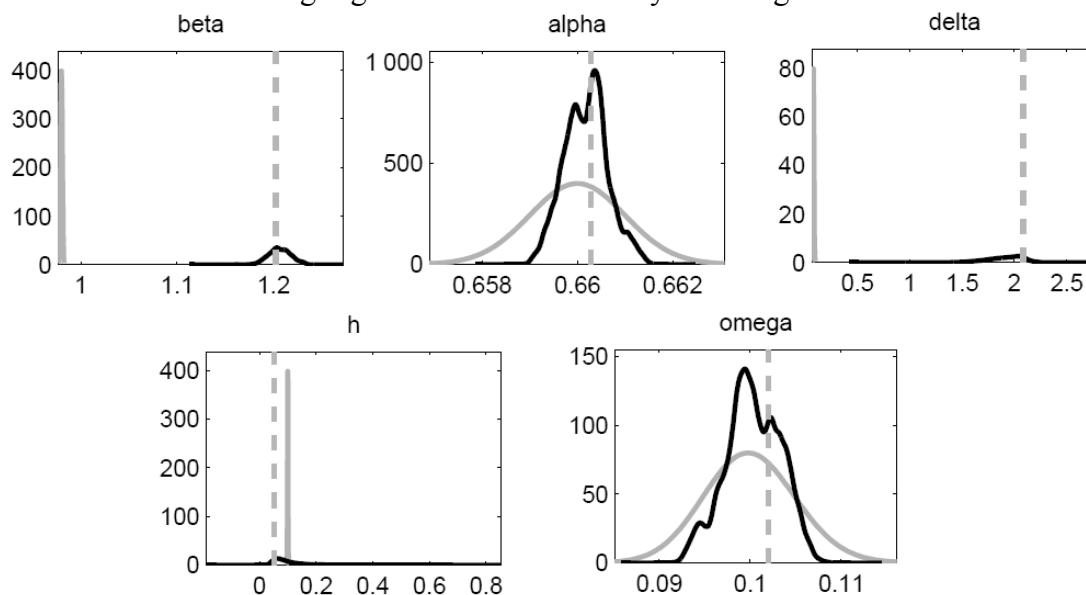

Figure 1: Prior and posterior distributions of estimated key parameters of Slovak economy

In similar way we could analyse the estimates of other parameters, but for the sake of the length of the paper we rather focused on the parameters relevant to the fiscal policy of Slovakia.

5.2 Estimated Parameters for the Fiscal Policy of Slovakia

In the paper Horvát, König and Ostrihoň [3] the values of the fiscal and monetary policy parameters were estimated using Ordinary Least Squares method (OLS). Estimated values were used as priors in the first run of the Bayesian estimation. Comparison of the estimated values of the parameters is shown in the table 3. In general, it is possible to observe that values of the autoregressive (AR) coefficients are underestimated using OLS inference compared to the Bayesian estimation. Values of the AR coefficients were estimated around 0.8 for government expenditure, consumption and labour tax and interest rate coefficients and 0.7 for capital tax coefficient according to posterior mean using Bayesian techniques. The tax rate debt coefficients supposed to have positive sign to output-debt ratio. The assumption is not satisfied in the OLS inference but it is satisfied for the Bayesian estimation. Values of those parameters are close to the values stated by Iwata [4]. One exception is labour tax debt coefficient which is significantly higher. For the conditions of Slovakia the Taylor rule coefficients for the monetary policy often have higher estimated values than in the standard economies using Bayesian techniques. The same result is valid for the estimation of the interest rate output gap coefficient which has value 0.5002 compared to the standardly used value 0.125.

Table 3: Estimated values of parameters comparison based on the regression and Bayesian inference

Parameter	Regression	Bayesian
ρ_g	0.471035	0.8166
ϕ_{gy}	-0.08883	0.112
ρ_{tc}	0.229268	0.8
ϕ_{tcb}	0.00031	0.1006
ρ_{td}	0.3816	0.7998
ϕ_{tdb}	-0.12554	0.2854
ρ_{tk}	0.305743	0.7
ϕ_{tkb}	0.02789	0.1051
ρ_r	0.748697	0.8005
$\phi_{r\pi}$	0.495004	1.6999
ϕ_{ry}	1.540336	0.5002

Source: Authors' calculations.

The comparison of the prior (grey curve) and posterior (black curve) distribution is presented in the figure 2. Based on the figure 2 we have reason to believe that estimated values of the monetary and fiscal policy parameters are appropriate.

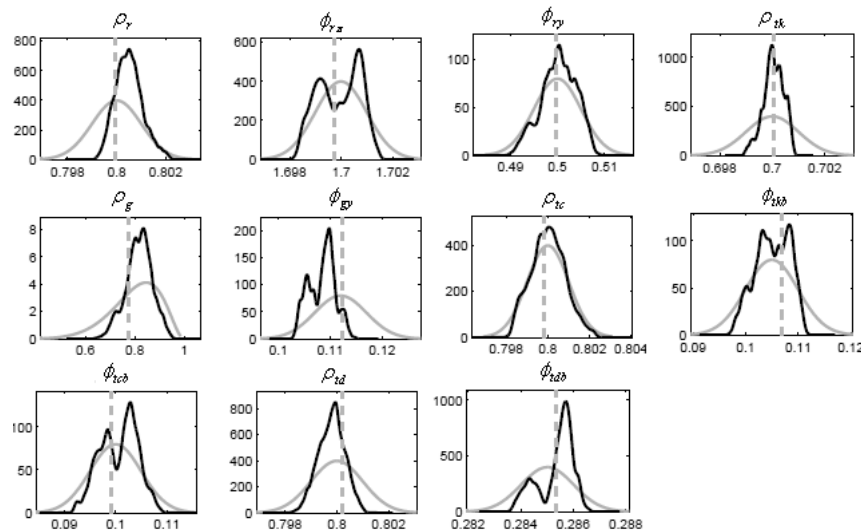

Figure 2: Prior and posterior distributions of fiscal and monetary policy parameters

6 CONCLUSION

In the presented paper an estimation of new Keynesian model, focused on governmental decision making, has been provided. For the estimation a prior distribution was necessary for all of the parameters to initialize the estimation procedure using MH-MCMC algorithm. Set values naturally affect the outcomes of the estimation. Therefore we have iterated the procedure multiple times to ensure that the parameters will obtain values in accordance to the historical data, unbiased by the prior information. Unfortunately as may be seen by the comparison of the prior and posterior distribution for selected parameters, there are still parameters for which additional runs of Bayesian estimation are necessary to obtain a relevant fit. We are aware that for the presented parameters β and δ in the section 5.1, the posterior distributions clearly missed the prior, and we admit that there are still many non-presented parameters, which exhibit the same flaw. Unfortunately the chosen model is of larger scale and therefore it takes much longer to estimate it properly. For the future research we intend to continue with the estimations until stable posteriors has been reached. Concerning the current results of the estimation, it is important to note that they are only preliminary and may change in the process of future estimation.

Acknowledgements: This paper is supported by the Grant Agency of Slovak Republic - VEGA, grant no. 1/0595/11 "Analysis of Business Cycles in the Economies of the Euro Area (with Regards to the Specifics of the Slovak Economy) Using Econometric and Optimization Methods" and grant no. 1/0285/14 "Regional modelling of the economic growth of EU countries with concentration on spatial econometric methods".

References

- [1] Domonkos, T., Domonkos, Š., Jánošová, M. and Grisáková, N. (2013) 'The effect of the formula apportionment of the Common Consolidated Corporate tax Base on tax revenue in the Slovak Republic', *Ekonomický časopis*, vol. 61, no. 4, pp. 453-467.
- [2] Horvát, P., König, B. and Ostrihoň, F. (2013) 'The Impact of the Technological Progress on the Development of the Slovak Economy – Neoclassical approach', *Mathematical Methods in Economics 2013 – Conference Proceedings (part I)*, The Czech Society for Operations Research Conference, Jihlava, pp. 291-296.
- [3] Horvát, P., König, B. and Ostrihoň, F. (2013) 'The Basis for Modelling the Fiscal Shocks' Impact on the Business Environment of Slovakia', *Business trends*, vol. 4, pp. 11-19.

- [4] Iwata, Y. (2009) *Fiscal Policy in an Estimated DSGE Model of the Japanese Economy: Do Non-Ricardian Households Explain All?*, [Online], Available: http://www.esri.go.jp/en/archive/e_dis/abstract/e_dis216-e.html [13 Oct 2013].
- [5] Szomolanyi, K., Lukáčik, M. and Lukáčiková, A. (2012) 'Estimate of Parameters of Production Function of Slovak Economy: Econometric Analysis of Nominal Wages', *Quantitative Methods in Economics: Multiple Criteria Decision Making XVI – Conference Proceedings*, The Slovak Society for Operations Research Conference, Bratislava, pp. 210-215.
- [6] Smets, F. and Wouters, R. (2002) *An Estimated Stochastic Dynamic General Equilibrium Model of the Euro Area*, [Online], Available: www.ecb.europa.eu/pub/pdf/scpwps/ecbwp171.pdf [13 Oct 2013].
- [7] Zeman, J. and Senaj, M. (2009) *DSGE Model – Slovakia*, [Online], Available: http://www.nbs.sk/_img/Documents/PUBLIK/WP_3-2009%20DSGE%20Slovakia.pdf [13 Oct 2013].
- [8] Zeman, J., Výškrabka, M. and Senaj, M. (2010) *MUSE: Monetary Union and Slovak Economy model*, [Online], Available: http://www.nbs.sk/_img/Documents/PUBLIK/WP_1-2010.pdf [13 Oct 2013].

Author's address

Ing. Peter Horvát

University of Economics in Bratislava, Faculty of business informatics, Department of Operations research and Econometrics, Dolnozemská 1/b, 852 35 Bratislava /

Slovak Academy of Sciences, Institute of Economic Research,

Šancová č. 56, 811 05 Bratislava

Slovak Republic

email: 1peter.horvat@gmail.com

Ing. Brian König, PhD.

University of Economics in Bratislava, Faculty of business informatics, Department of Operations research and Econometrics, Dolnozemská 1/b, 852 35 Bratislava

Slovak Republic

email: konigbrian@gmail.com

Ing. Filip Ostrihoň

University of Economics in Bratislava, Faculty of business informatics, Department of Operations research and Econometrics, Dolnozemská 1/b, 852 35 Bratislava /

Slovak Academy of Sciences, Institute of Economic Research,

Šancová č. 56, 811 05 Bratislava

Slovak Republic

email: filip.ostrihon@euba.sk

EXPLORING FACTORS OF WORKERS ALLOCATION INTO OCCUPATION IN SLOVAKIA

Peter Horvát,
University of Economics in Bratislava

Abstract

In this paper we present results based on the European Union Labour Force Survey micro-data complemented by the information from the Information System on Average Earnings in Slovakia. Using this data we analyze the decisions of individuals on the combination of economic sector and occupation where they accept employment. These decisions determine the allocation of supply of labour on the labour market. We identify two basic groups of factors influencing individuals' decisions: individual (gender, age, education, and region), market (wage, unemployment, dynamic of employment). We explore these factors using a multinomial logistic regression model approach. The data allow us to compare the contributions of particular factors to individuals' decisions. Allocation functions projecting individuals into economic sectors and occupations will be constructed.

Keywords: workers allocation function, multinomial logistic regression, micro-data estimation

JEL Classification: J2

AMS Classification: 91B40

1. INTRODUCTION

This study uses a strictly empirical approach to explore the factors influencing allocation of individuals into jobs. Coefficients acquired logistic regression based analysis are produced in the way they could be later employed in a wider structural model projecting the structure of Slovak labour market based on demographic projections and a macroeconomic model. The list of individual characteristics involved in the model was therefore influenced by the characteristics covered in demographic projections and mainly the list of sectors was determined by the structure of the macroeconomic model linked to this exercise.

Allocation was captured in two moments; one covers the allocation of individuals into economic sectors and the other the allocation into occupations. The structure of this paper as of the results corresponds to this distinction. In the first part of the paper we describe the data used in the analysis and the estimation strategy. Results are presented separately for allocation into economic sectors and allocation into occupations.

2. DATA USED

Two main micro-data sources were used for the analysis. Labour Force Survey (LFS) micro-data database for years 1998- 2012 provided by the Statistical Office of the Slovak republic to the Institute of Economic Research of Slovak Academy of Sciences (IER SAS) is used to obtain demographic characteristics of population, unemployment rate and economic sector dynamics. Main problem with LFS data is presence of structural break in the time series of economic sector. The Statistical Office of Slovak republic changed economic sectors classification from NACE rev.1 to NACE rev. 2. In order to secure consistency of the data and to reduce computational difficulty, we aggregate economic sectors and occupations into 11 sectors and 10 occupations. Sectors are:

- 1 Agriculture, forestry and fishery
- 2 Mining, gas, oil extraction and processing, energy industry
- 3 Industry
- 4 Construction
- 5 Retail

- 6 Information and Telecommunication services
- 7 Finances
- 8 Real Estate
- 9 Administrative, scientific, technical and support services
- 10 Public services, education, health and social services
- 11 Arts, entertainment industry and other non-public service

Occupations correspond to ISCO-08 1 digit classification:

- 1 Managers
- 2 Professionals
- 3 Technicians and associate professionals
- 4 Clerical support workers
- 5 Service and sales workers
- 6 Skilled agricultural, forestry and fishery workers
- 7 Craft and related trades workers
- 8 Plant and machine operators and assemblers
- 9 Elementary occupations
- 0 Armed forces occupations

Second input is micro-data database of Information System on Average Earnings for years 2004-2011 provided by TREXIMA Bratislava to IER SAS. Based on this dataset, average hourly wages for economic sectors and occupations are computed.

3. METHODOLOGY

Demographic characteristics such as gender, age and education are main qualitative determinants of labour market supply and are used as approximation of the productivity of individual. They all affect possibility of finding new job, level of wage and security of employment. Therefore, we analyze influence of demographic characteristics on the decision process of individuals where they accept employment. Following demographic characteristics were obtained from LFS data:

- Gender (male, female)
- Age group (15-19, 20-24, 25-29,30-34,35-39,40-44,45-49, 50-54,55-59,60-64, 65-69, 70-74, 75+)
- Region (Bratislava, Trnava, Trenčín, Nitra, Žilina, Banská Bystrica, Prešov, Košice region)
- Level of education (without education or primary, secondary without graduation, secondary with graduation, tertiary)
- Field of education, based on the ISCED 97 classification (Basic programmes, Literacy and numeracy, Personal development, Teacher training and education science, Arts, Humanities, Social and behavioural science, Journalism and information, Business and administration, Law, Life sciences, Physical sciences, Mathematics and statistics, Computing, Engineering and engineering trades, Manufacturing and processing, Architecture and building, Agriculture, forestry and fishery, Veterinary, Health, Social services, Personal services, Transport services, Environmental protection, Security services, non know or unspecified)

On the other side, we examine market factors, such as unemployment rate, average hourly wage in the economic sector or occupation and growth rate of the sector which affect demand side of the market. The full equation of the individual's decision about economic sector where he/she accepts employment is:

$$\begin{aligned} \text{LOG} \left(\frac{P_{i,j}}{P_{i,1}} \right) = & \beta_{0,j} + \beta_{1j} \text{GENDER}_{i,\text{Dummy}(2)} + \beta_{2j} \text{AGE}_{i,\text{Dummy}(2-13)} + \beta_{3j} \text{REGION}_{i,\text{Dummy}(2-8)} \\ & + \beta_{4j} \text{L_EDU}_{i,\text{Dummy}(2-4)} + \beta_{5j} \text{F_EDU}_{i,\text{Dummy}(1-17,19-26)} + \beta_{6j} \text{UR} + \beta_{7j} \text{W}_j \\ & + \beta_{8j} \text{SG}_j \end{aligned} \quad (1)$$

where economic sector 1 was chosen as base outcome, i represents individual, j economic sector (2-11), $\text{LOG}\left(\frac{P_{ij}}{P_{i,1}}\right)$ is logarithm of the odds ratio, $GENDER$, AGE , $REGION$, L_EDU , F_EDU are dummy variables for individual demographic factors, UR refers to unemployment rate, W_j average hourly wage in sector j and SG_j growth rate of the sector j . Similar equation is used to estimate individual's decision about occupation:

$$\text{LOG}\left(\frac{P_{i,k}}{P_{i,1}}\right) = \beta_{0,k} + \beta_{1k} GENDER_{i,Dummy(2)} + \beta_{2k} AGE_{i,Dummy(2-13)} + \beta_{3k} REGION_{i,Dummy(2-8)} + \beta_{4k} L_EDU_{i,Dummy(2-4)} + \beta_{5k} F_EDU_{i,Dummy(1-17,19-26)} + \beta_{6j} UR + \beta_{7k} W_k \quad (2)$$

where occupation 1 was chosen as base outcome, k represents occupation (0, 2-9) and W_k average hourly wage in occupation k . Multinomial logistic regression approach was used to estimate equations (1) and (2). After estimation we have computed marginal effects of variables on alternatives probability.

4. ESTIMATION RESULTS

Summary statistics for both models are displayed in the Table 1.

Table 1: Summary statistics of mlogit estimation of sector and occupation

	Sector	Occupation
Number of obs.	348585	350575
LR chi2(443)	464821.2	595556.5
Prob > chi2	0	0
Log likelihood	-438396	-425847
Pseudo R²	0.3465	0.4115

Comparison of estimated mean probabilities of individual being employed in one of economic sectors or occupations and real mean share of economic sector and occupation on the whole employment are shown in the Table 2. It is possible to observe slight differences between estimated and actual data on proportions of employed. There is no difference in the order of alternatives, but in an overestimation or underestimation of the share of employees. The model overestimates the proportion of employees in industry and retail sector, which is actually 25% respectively 22.8% of employment, but the model predicts proportion about 34.8%, respectively 32.7% of the whole employment. On the other hand, the model underestimates the number of employees in other sectors. The situation is similar when looking at the occupations. The model overestimates around 10% the proportion of technicians and associate professionals. On the other side the share of managers is undervalued five times.

Table 2: Predicted mean probabilities and real mean share of sectors and occupations

Sector			Occupation		
No.	Estimated probability	Real share	No.	Estimated probability	Real share
1	0.010762	0.040724	0	0.001694	0.005587
2	0.012752	0.032221	1	0.00905	0.057708
3	0.347583	0.255125	2	0.071155	0.10909
4	0.058831	0.102316	3	0.283018	0.188774
5	0.32691	0.228127	4	0.090034	0.063212
6	0.000281	0.017933	5	0.142639	0.145626
7	0.000261	0.021587	6	0.004628	0.009674
8	0.006279	0.005495	7	0.164604	0.180684
9	0.017235	0.05547	8	0.165995	0.144277
10	0.210932	0.210579	9	0.067183	0.095368
11	0.008174	0.030425			
Sum	1	1	Sum	1	1

Source: Author's calculation

GENDER₂	-0.0069	-18.6	-0.014	-23.2	-0.0277	-10.9	-0.1367	-71.1	0.0116	4.7	0.0000414	-23.2
AGE₂	0.0032	1.5	-0.007	-5.4	-0.0832	-5.9	-0.0086	-2.1	-0.0003	-0.02	-0.007	-5.4
AGE₃	0.0042	2	-0.0061	-4.2	-0.1364	-10.2	-0.0158	-4.1	-0.0162	-1	-0.0061	-4.2
AGE₄	0.0043	2	-0.0025	-1.3	-0.1578	-12.1	-0.0181	-4.9	-0.0519	-3.2	-0.0025	-1.3
AGE₅	0.0067	2.8	-0.0033	-1.8	-0.1906	-15.8	-0.0219	-6.2	-0.0541	-3.3	-0.0033	-1.8
AGE₆	0.0072	2.9	-0.0009	-0.4	-0.2029	-16.6	-0.0221	-6.1	-0.0881	-5.5	-0.0009	-0.4
AGE₇	0.0093	3.5	-0.0018	-0.9	-0.2068	-17.4	-0.0225	-6.3	-0.1084	-7.4	-0.0018	-0.9
AGE₈	0.0123	4.1	-0.002	-1	-0.2228	-18.6	-0.0238	-6.6	-0.1362	-9.3	-0.002	-1
AGE₉	0.0132	3.9	-0.0054	-3.7	-0.2408	-21.5	-0.031	-9.7	-0.1573	-10.8	-0.0054	-3.7
AGE₁₀	0.0141	3.5	-0.0079	-7.3	-0.2689	-30.4	-0.0319	-9.8	-0.1624	-10.3	-0.0079	-7.3
AGE₁₁	0.0186	2.8	-0.0104	-11.9	-0.2962	-29.4	-0.0333	-6.4	-0.1643	-6.2	-0.0104	-11.9
AGE₁₂	-0.0103	-12.6	-0.0101	-7.9	-0.2889	-16.9	-0.048	-11.6	-0.1373	-2.9	-0.0101	-7.9
AGE₁₃	0.0056	0.5	-0.0066	-1.6	-0.1876	-4.1	-0.0001	0	-0.2342	-6.8	-0.0066	-1.6
REGION₂	0.0058	8.8	0.0034	5.2	0.1659	34.6	-0.0039	-2.5	-0.0893	-25	0.0034	5.2
REGION₃	0.0017	3.1	0.0032	4.8	0.2559	54.7	-0.007	-4.7	-0.1497	-44.9	0.0032	4.8
REGION₄	0.0098	12	-0.0024	-4.6	0.1571	31.7	-0.0056	-3.7	-0.092	-25.1	-0.0024	-4.6
REGION₅	0.0026	4.7	-0.0015	-2.9	0.1799	38.6	0.0324	15.9	-0.1262	-38	-0.0015	-2.9
REGION₆	0.011	12.8	0.0003	0.5	0.1548	31.1	-0.0162	-11.4	-0.107	-29.9	0.0003	0.5
REGION₇	0.0055	9	-0.0032	-6.7	0.1398	30.6	0.0344	17.3	-0.1211	-36.9	-0.0032	-6.7
REGION₈	0.0038	6.3	0.0023	3.7	0.116	24.3	-0.0152	-11.2	-0.086	-24.5	0.0023	3.7
L_EDU₂	-0.0113	-12	-0.013	-13.8	-0.1178	-17.7	-0.0213	-8.3	0.1794	24.7	-0.013	-13.8
L_EDU₃	-0.0181	-17.6	-0.016	-13.9	-0.1726	-27.1	-0.0408	-15.3	0.148	22.5	-0.016	-13.9
L_EDU₄	-0.012	-14.6	-0.0126	-19.6	-0.2169	-39.6	-0.0453	-25.9	-0.0134	-1.8	-0.0126	-19.6
UR	-0.0036	-18.7	0.0049	26.8	0.0231	51.1	-0.0038	-23.5	-0.0109	-25.4	0.0049	26.8
SG	-0.1985	-15.2	0.037	9.6	-0.3311	-8.6	0.0147	1.1	0.9054	23.8	0.037	9.6
W	-0.0317	-19	0.0387	28.6	0.1916	87.9	-0.0276	-33.8	-0.0722	-35.1	0.0387	28.6

	Sector 7		Sector 8		Sector 9		Sector 10		Sector 11	
Variable	dy/dx	z	dy/dx	z	dy/dx	z	dy/dx	z	dy/dx	z
GENDER₂	0.0002	11.9	0.0011	3.2	-0.0012	-3.3	0.163	71.2	0.0038	16
AGE₂	-0.0001	-1.8	0.0216	0.9	-0.0017	-0.7	0.0804	3.7	-0.001	-1.1
AGE₃	-0.0001	-2.6	0.027	1	-0.003	-1.3	0.1526	6.3	-0.0018	-2.2
AGE₄	-0.0001	-2.3	0.0267	1	-0.0058	-2.8	0.2127	8.3	-0.0029	-4.1
AGE₅	-0.0002	-3.4	0.028	1	-0.0079	-4.2	0.2543	9.5	-0.0041	-6.5
AGE₆	-0.0001	-2.8	0.0341	1	-0.0078	-4.2	0.2921	10.3	-0.004	-6.2
AGE₇	-0.0002	-4.9	0.028	1	-0.0082	-4.4	0.3244	11.9	-0.0043	-6.9
AGE₈	-0.0002	-4.9	0.0388	1.1	-0.0079	-4.2	0.3579	11.7	-0.0037	-5.5
AGE₉	-0.0003	-8.8	0.0448	1	-0.0109	-7.5	0.403	11.4	-0.002	-2.4
AGE₁₀	-0.0003	-13.6	0.0495	1	-0.0083	-4.9	0.4301	10.2	0.0001	0.1
AGE₁₁	-0.0002	-7.4	0.119	1.1	-0.0076	-3.3	0.3904	4.8	0.0028	1.2
AGE₁₂	-0.0002	-5.5	0.2107	1.2	-0.0116	-5.8	0.2861	2.5	0.0012	0.4
AGE₁₃	-0.0003	-10.8	0.0682	0.8	-0.0033	-0.7	0.3627	4.3	0.0015	0.4
REGION₂	-0.0002	-12	-0.0018	-4.7	-0.0086	-21.7	-0.0631	-20.8	-0.0026	-10.4
REGION₃	-0.0002	-11.8	-0.0045	-13.1	-0.0125	-34.2	-0.08	-27	-0.0051	-21.2
REGION₄	-0.0002	-11.3	-0.0024	-6.3	-0.0116	-30.7	-0.04	-11.9	-0.0032	-12
REGION₅	-0.0002	-14.1	-0.0045	-12.7	-0.0133	-36	-0.0623	-20.8	-0.0042	-17.5
REGION₆	-0.0002	-11	-0.0041	-11.6	-0.0094	-24.2	-0.015	-4.3	-0.0035	-13.9
REGION₇	-0.0002	-12	-0.0045	-12.7	-0.0136	-36	-0.0272	-8.6	-0.0044	-18.6

REGION ₈	-0.0002	-13.2	-0.0041	-11.8	-0.0102	-26.9	0.0002	0.1	-0.0028	-11
L_EDU ₂	0.0009	4.4	-0.0004	-0.4	-0.0029	-2.8	-0.0328	-6.1	0.0079	8.8
L_EDU ₃	0.0016	6.1	0.0046	4.4	0.0064	6.1	0.058	11.3	0.0107	13
L_EDU ₄	0.0053	4.2	0.0079	4.1	0.0208	10.2	0.2418	30.4	0.012	8.6
UR	0.0002	17.4	0.0002	2.7	0.0077	57.9	-0.0176	-45.4	-0.0038	-43.1
SG	0.003	14.8	0.0707	14	0.1748	33.4	-0.8085	-22.7	-0.0666	-17.6
W	0.0013	17.3	0.0001	0.3	0.0583	67.9	-0.1612	-90.3	-0.029	-45.2

Source: Author's calculation

4.2. Occupation results

The results of estimation of marginal effects in army forces occupation weren't statistically significant and are not included in the Table 4. The same is valid for dummy variables describing field of education. From the gender perspective is evident that men have the highest probability being employed in the occupation craft and related workers. Conversely women have the highest probability being employed in the occupation sales and service workers. In the age structure is not possible to find aging tendencies like in the economic sectors age structure. On the contrary with the increasing age is possible to detect decline in likelihood to be hired as manager or craft and related workers. In other professions the likelihood development are mixed. From a regional perspective is possible to observe an increased likelihood to be employed in the four highest levels of the occupations in the Bratislava region and decrease in the likelihood of other professions. Against economical intuition are results for the manager occupation, where according to the maximum likelihood estimation the highest likelihood to be employed as a manager has person with primary education and with the growth of level of education is the probability decreasing. For the rest of higher profile occupations such as professionals, technicians and clerical support workers the marginal effects on the probability correspond with expectations and intuition. The probability grows with growth of the level of education. For the other occupations is luxury to have high level of education. This corresponds with the results where we can see the decrease of probability with increasing levels of education. If the unemployment rate will increase by 1%, this change will cause increase of the probability to be employed as manager, professional, technicians or craft and related workers. While in other occupations this development will cause decrease of the probability. A 1 % increase in the average hourly wages in corresponding occupation will cause increase of the likelihood to be employed for majority of occupations but the most increase by 0.084 is in the technicians and associate professionals occupation. On the other hand the highest decline in probability to be employed will be in the elementary occupations.

Table 4: Computed marginal effects on the probabilities of occupations and individuals matching

Variable	ISCO 1		ISCO 2		ISCO 3		ISCO 4		ISCO 5	
	dy/dx	z	dy/dx	z	dy/dx	z	dy/dx	z	dy/dx	z
GENDER ₂	-0.0031	-10	0.0118	9.7	0.086	27.8	0.089	47.5	0.11	39.9
AGE ₂	-0.0034	-2.4	-0.0408	-8.7	-0.0373	-2.4	-0.0053	-0.7	0.0533	5.1
AGE ₃	-0.0052	-4.3	-0.03	-5.1	0.0036	0.2	0.0034	0.4	0.0448	4.5
AGE ₄	-0.0054	-4.5	-0.0236	-3.7	0.0253	1.5	-0.0036	-0.5	0.032	3.3
AGE ₅	-0.005	-4	-0.028	-4.6	0.0394	2.3	-0.0104	-1.5	0.0305	3.2
AGE ₆	-0.0047	-3.6	-0.0223	-3.4	0.0373	2.2	0.0009	0.1	0.007	0.8
AGE ₇	-0.0048	-3.6	-0.0179	-2.6	0.0324	1.9	-0.0046	-0.6	0.0057	0.7
AGE ₈	-0.0053	-4.2	-0.0094	-1.2	0.0498	2.8	-0.0018	-0.2	-0.0013	-0.2
AGE ₉	-0.0056	-5.3	-0.0096	-1.3	0.0466	2.6	0.0015	0.2	0.0215	2.3
AGE ₁₀	-0.0056	-6.3	0.0109	1.1	0.0164	0.9	0.0039	0.4	0.0621	4.7
AGE ₁₁	-0.0061	-6.5	0.004	0.4	-0.0615	-2.8	0.0209	1.4	0.0888	3.8
AGE ₁₂	-0.0046	-2.3	-0.0144	-1.3	-0.001	-0.03	-0.0004	-0.02	0.0607	1.9

AGE₁₃	-0.0064	-3.4	-0.0157	-0.9	-0.168	-4.4	-0.0709	-5	0.0344	0.6
REGION₂	-0.0006	-1.3	-0.0171	-10.9	-0.1015	-29.3	-0.0187	-10.3	0.0279	8.2
REGION₃	-0.0007	-1.4	-0.0227	-14.5	-0.1075	-29.5	-0.046	-28.4	0.0051	1.6
REGION₄	-0.0005	-0.9	-0.0255	-16.5	-0.1066	-30.1	-0.0413	-25.1	0.0372	10
REGION₅	-0.0002	-0.3	-0.029	-20.4	-0.1178	-34.9	-0.0573	-37.9	0.0252	7.7
REGION₆	-0.001	-2.1	-0.0158	-9.9	-0.1132	-33.1	-0.0489	-31.4	0.036	9.3
REGION₇	4.39E-05	0.1	-0.0299	-21.5	-0.1419	-43.3	-0.0549	-36	0.0303	9.4
REGION₈	0.0001	0.2	-0.0276	-19.7	-0.1054	-31.5	-0.0341	-20.9	0.0497	13.7
L_EDU₂	-0.0084	-10.4	-0.0792	-19.6	-0.1018	-11.5	0.1253	17.7	0.1339	21.2
L_EDU₃	-0.0195	-15.1	0.0205	5	0.2442	27.8	0.1521	26.1	0.0705	15.1
L_EDU₄	-0.0141	-31.7	0.2256	17.8	0.22	17.6	0.126	13.6	-0.0064	-1.2
UR	0.0017	24.2	0.0011	5.7	0.0016	3.8	-0.0004	-1.9	-0.002	-7.8
W	0.0176	46.4	0.0323	46.4	0.0837	54.1	-0.0166	-19.4	-0.0908	-40.4

Variable	ISCO 6		ISCO 7		ISCO 8		ISCO 9	
	dy/dx	z	dy/dx	z	dy/dx	z	dy/dx	z
GENDER₂	-0.0023	-0.7	-0.1951	-42.5	-0.1045	-37.9	0.0114	10.4
AGE₂	0.0043	0.7	-0.0009	-0.1	0.0322	3	-0.0083	-2.2
AGE₃	0.0039	0.7	-0.01	-1.1	0.0044	0.5	-0.021	-6.4
AGE₄	0.003	0.6	-0.0107	-1.2	0.0031	0.3	-0.0257	-8.3
AGE₅	0.006	0.7	-0.0112	-1.2	0.0015	0.2	-0.026	-8.4
AGE₆	0.005	0.7	-0.0062	-0.7	0.0049	0.5	-0.023	-7.2
AGE₇	0.0076	0.7	-0.0024	-0.3	0.0087	0.9	-0.0247	-7.8
AGE₈	0.0068	0.7	-0.0093	-1	-0.0102	-1.1	-0.0188	-5.5
AGE₉	0.0055	0.7	-0.0266	-3.1	-0.0212	-2.3	-0.0106	-2.8
AGE₁₀	0.0042	0.6	-0.0525	-6.6	-0.0465	-5.4	0.0104	1.9
AGE₁₁	0.0235	0.7	-0.0899	-8.1	-0.0683	-4.9	0.0887	5.5
AGE₁₂	-0.0047	-0.7	-0.0669	-2.9	-0.1037	-5.2	0.1377	4.7
AGE₁₃	0.0998	0.7	0.0089	0.1	0.0077	0.1	0.1127	2
REGION₂	0.0008	0.7	0.0516	13.1	0.0395	10.5	0.0205	9.2
REGION₃	-0.001	-0.7	0.0994	21.8	0.0473	12.1	0.0254	10.7
REGION₄	0.0025	0.7	0.0349	9.1	0.0853	19.1	0.0156	7.1
REGION₅	-0.0002	-0.5	0.1	22.7	0.0443	12	0.0358	14.8
REGION₆	0.0046	0.7	0.0522	11.9	0.0627	14	0.0234	9.5
REGION₇	-0.0009	-0.7	0.1075	24.7	0.0544	14.8	0.0352	15.1
REGION₈	0.0008	0.7	0.03	8.4	0.0477	12.6	0.0387	15.2
L_EDU₂	-0.0068	-0.7	0.0697	10.2	-0.0259	-5	-0.1082	-30.8
L_EDU₃	-0.0127	-0.7	-0.0853	-13.5	-0.1629	-24.9	-0.2101	-30.5
L_EDU₄	-0.0059	-0.7	-0.1958	-37.3	-0.2465	-65.6	-0.1094	-52.6
UR	-0.0002	-0.7	0.0016	5.7	-0.0014	-4.7	-0.002	-13.3
W	-0.0033	-0.7	0.0145	11.7	0.0158	12.8	-0.0531	-52.4

Source: Author's calculation

5. CONCLUSIONS AND DISCUSSION

In this paper we have tried to explore and describe the factors influencing allocation of individuals entering Slovak labour market into economic sectors and occupations. We have taken into account demographic characteristics of individuals, as well as characteristics referring to the situation on the labour market.

Fields of education originally included into the analysis brought insignificant and unclear results. For this reason we have decided not to include them into the interpretation. The analysis in this area is in need of some more refinement. Other form of aggregation could bring reasonable results.

Demographic characteristics such as gender, age, region and level of education showed to play a significant role in allocation into economic sectors as well as occupations. The probabilities of allocation depend on these characteristics and in depth exploration helps to understand and identify the crucial dynamics in the structure of Slovak labour market.

Market characteristics also seem to play an important role in the allocation into economic sectors and occupations. Unfortunately, because of the differences in measurement, the coefficients acquired for demographic and market characteristics are not comparable in absolute terms. Nevertheless significance and the direction of their contribution can be interpreted.

The strength of models which were applied was limited by the list of characteristics which was possible to include as explanatory variables. This was determined by the structure of involved demographic projections and the output of a macroeconomic model.

Acknowledgements: This work was supported by the Slovak Research and Development Agency under the contract No. APVV-0541-10

References:

- [1] Bujňáková, T. and Štefánik, M. (2013) 'Projekcie počtu ekonomicky aktívneho obyvateľstva v závislosti od zvyšovania veku odchodu do dôchodku s využitím logit modelu', *Ekonomický časopis*, vol. 61, no. 10, pp. 1011-1033.
- [2] Radvanský, M., Domonkos, T., Lichner, I., Štefánik, M., Weyerstrass, K. and Haluška, J. (2013) *Labour market analysis and long-term forecast up to 2025: forecast inf. report. Skopje (Macedonia)*, Skopje: Ministry of Labour and Social Policy, 18.4.2013.
- [3] Štefánik, M. and Hošťáková, Z. (2011) 'Nezamestnanosť a prevzdelanosť ako situácie znižujúce kvalitu života obyvateľov Slovenska: (spracovanie dát z VZPS)', in Juhaščíková, I. and Štukovská, Z. (ed.) *Kvalita života v podmienkach globalizácie*, Bratislava: Štatistický úrad SR.
- [4] Štefánik, M.: (2012), 'Internet job search data as a possible source of information on skills demand (with results for Slovak university graduates)', *Building on skills forecasts - comparing methods and applications* – Conference Proceedings, Publications Office of the European Union, Luxembourg, pp. 246-260.
- [5] Workie Tiruneh, M., Bujňáková, T., Horvát, P., Lichner, I. and Štefánik, M. (2012) *Predvídanie potrieb trhu práce v SR: teoretické východiská a empirické výsledky*, Bratislava: Ekonóm.

Author's address

Ing. Peter Horvát

Address 1: University of Economics in Bratislava, Faculty of business informatics, Department of Operations research and Econometrics

Dolnozemska 1/b, 852 35 Bratislava

Slovak Republic

Address 2: Institute of Economic Research (EU SAV)

Sancova No. 56, 811 05 Bratislava

Slovak Republic

email: 1peter.horvat@gmail.com

FACTORING CREDIT RISK AND ITS SECURITY MODELING

*Eduard Hozlár,
Comenius University in Bratislava*

Abstract

Factoring company provides financial services based on granting of a loan secured by assignment of receivables. The paper concerns of modelling default risk of the provided loan and safeguarding of the risk by a borrower trade receivables. An optimal balance between the risk of default of credit drawn down and the level of coverage receivables against customers is looking for. Among important factors there are financial indicators of the company and objectified prices of a set of receivables owing to customers. In this paper we present an approach that as a result provides an optimal size of the security for the loan drawn under the lending factoring.

Keywords: *receivables, risk modelling, optimization*

1. FACTORING

Factoring is an agreement between a factor and a supplier in which the factor purchases the supplier's accounts receivable. *Non-recourse factoring* is an agreement which assumes responsibility for the supplier's customers' financial inability to pay – *in this case factor assumes the risk of non-payment accounts receivable*. In a case *recourse factoring factor has no risk of non-payment accounts receivable*. Factor however in both cases has the risk of non-payment of a loan that was given to the supplier.

The factor may provide the supplier with cash advances (loan) prior to the maturity date of the invoices. This allows the supplier to be paid upon shipment while actually offering credit terms to its retailers. Typical advance rates are up to 90% of the value of the invoice. These advances are subsequently repaid by collection proceeds from their retailers.

1.1 Recourse factoring

In recourse factoring, the factor turns to the client (seller), if the receivables become bad, i.e. if the customer does not pay on maturity. The risk of bad receivables remains with the client, and the factor does not assume any risk associated with the receivables. The factor provides the service of receivables collection, but does not cover the risk of the buyer failing to pay the debt. The factor can recover the funds from the seller (client) in the case of such default. The seller assumes the risks associated with the credit and the buyer's creditworthiness. The factor charges the seller for the management of receivables and debt collection services, while also charging interest on the amount advanced to the client (seller).

1.2 Client's costs associated with factoring

There are two cost associated with factoring:

- the factoring commission and
- the interest charged on advances against receivables.

The factoring commission is quoted as a percentage of factored volume, and typically ranges from about 0.40% of sales to approximately 2.0% of sales. It is based upon these variables:

- Factored sales volume
- Average invoice size
- Terms of sale
- Number of customers
- The creditworthiness of your customers

If you are borrowing, the interest rate is competitive with short-term revolving credit interest rates. Interest is charged monthly at a rate tied to major interest rate indices.

2. DETERMINISTIC MODEL OF BALANCING THE RISK

One of the ways to reduce factor's credit risk in recourse factoring is to setting parameters for payments so that the cooperation with the client was a mutually useful. Let

- $P(i, t)$ value of the invoices (accounts receivables) in the month t and maturity of the invoices is i months ($i \leq n$),
- $C(i, t)$ - loan prior to the maturity date of the invoices $P(i, t)$,
- α - advance rates,
- L - credit limit of the client,
- p - factoring commission,
- r - interest rate,
- T - number of months,
- n - maximum number of months overdue invoices.

We assume that the invoices are paid in the due date. Further it is assumed that the client requires advance payment on all open (unpaid) invoices, up to a maximum credit limit L . Under these assumptions, the following relationship funding for client hold:

$C(i, t) = \alpha P(i, t)$, when

$$\alpha \sum_{j=1}^t \left(\sum_{i=1}^n C(i, j) - \sum_{i=1}^{j-1} C(i, j-i) \right) \leq L, \quad j > 1; \quad t = 1, 2, \dots, T;$$

otherwise $C(i, t) = 0$.

The annual factoring fee F is a percentage p of annual factored volume (annual sales):

$$F = p \sum_{i=1}^n \sum_{t=1}^T P(i, t)$$

The annual interest cost U is the sum of the monthly interest. Monthly credit is $u(t)$:

$$u(t) = \sum_{i=1}^n \sum_{j=t-i+1}^t C(i, j), \quad t = 1, 2, \dots, T$$

and annual interest cost is

$$U = \frac{r}{T} \sum_{t=1}^T u(t)$$

Client's annual cost of the funding is N :

$$N = F + U$$

2.1 The estimate of the average annual cost

To estimate the average annual cost of the client we just need to know the status of average monthly open invoices, and annual sales and parameters of factoring. In the month t the total volume of open claims $s(t)$ is :

$$s(t) = \sum_{i=1}^n \sum_{j=t-i+1}^t P(i, j), \quad t = 1, 2, \dots, T$$

Let us denote average monthly share of open claims on the annual volume of claims as β .

Then the average amount of monthly loan is

$$mi n \left(\alpha \beta \sum_{i=1}^n \sum_{t=1}^T P(i, t), L \right) \tag{1}$$

Client's average annual costs then can be written in the form

$$E(N) = (\alpha\beta r + p) \sum_{i=1}^n \sum_{t=1}^T P(i, t) \quad (2)$$

The expression $(\alpha\beta r + p)$ expresses the average share of the cost of the annual sales of the client. If for example funding $\alpha = 70\%$, factoring fee $p = 0.5\%$, the interest rate $r = 8\%$ and average monthly share of open claims on annual sales $\beta = 40\%$, then the annual cost of the client consists on average 2.74% of sales.

2.2 Client efficiency conditions from factoring services using

The client have to use the credit sources (1) under the costs (2) effectively. He has an opportunity to protract the invoices maturity but in this way he increases open claims *beta* can draw the higher credit but his costs increase as well. On the other hand in this way the client can use new resources to increase production and profit. The increase profit can cover the higher costs on external resources. The client needs to set an optimal level for his open claims. The risk of credit and connected costs payments is covered by producing sufficient number of claims. The client profit characteristic should not be worsen by credit using.

If we know profit level before taxes μ , then revenues have to be increased by

$$V_1 = \frac{N}{\mu}$$

so that the excess profit covered costs N . In other words the excess credit sources have to provide to profit increase in level N .

2.3 Factor efficiency conditions from factoring services providing

The factor conditions for credit providing on claims before their maturity have to bring expected rate of return from capital and factoring fee. If a factor provides to client in the month t the credit $u(t)$ with a credit rate $r\%$ *p. a.* , and from advanced claims he obtains in month t factoring fee at the rate p , then his monthly return is

$$W(t) = \frac{r u(t)}{T} + p \sum_{i=1}^n P(i, t)$$

and this return should not drop under the required level

It means that factor have to choice such levels of factoring parameters α, L, p, r so that the client have a possibility to produce open claims for credit using.

References

- [1] Elton, E. J., Gruber, M. J., Brown, S. J. and Goetzmann, W. N. (2009) *Modern Portfolio Theory and Investment Analysis*, 6th edition, New York: John Wiley & Sons Inc.
- [2] Horniaček, M. (2008) 'Negotiation, preferences over agreements, and the core', *International Journal of Game Theory*, vol. 37, no. 2, pp. 235-249.
- [3] Mlynarovič, V. (1989) *Modely a metódy viackriteriálneho rozhodovania*, Bratislava: Ekonóm.

Author's address

doc. RNDr. Eduard Hozlár, PhD.

Comenius University in Bratislava, Faculty social and economic Sciences, Institute of Economics

Mlynské luhy 4, 821 05 Bratislava

Slovak Republic

email: eduard.hozlar@fses.uniba.sk

RELATIONSHIP BETWEEN CONDITIONAL CORRELATION AND CONDITIONAL VOLATILITY: EVIDENCE FROM SELECTED CENTRAL AND EASTERN EUROPEAN MARKETS

*Michaela Chocholatá,
University of Economics in Bratislava*

Abstract

This paper investigates the relationship between dynamic conditional correlation (DCC) and conditional volatility. The analysis was provided on weekly data for the period 2003-2013 in order to avoid the noise (e.g. different national holidays, day-of-week effects) connected with the use of daily data. The analysis was twofold - in the first step after estimation of the univariate generalized autoregressive conditional heteroskedasticity (GARCH) models the multivariate DCC-GARCH models were estimated; in the second step the relationship between DCC and conditional volatility was assessed concerning the impact of the higher conditional volatility during the period October 17th, 2008 – December 25th, 2009. The whole analysis concentrates on the selected Central and Eastern European (CEE) markets (Czech Republic, Hungary, Poland) and their relationship to the Western European stock market represented by stock market of Germany and France, respectively, as well as on relationships between German and French market and between individual CEE markets.

Keywords: conditional volatility, GARCH, dynamic conditional correlation, DCC-GARCH

JEL Classification: G15, C58

AMS Classification: 91B84, 62P20

1 INTRODUCTION

The time-varying character of the stock returns' correlation is nowadays well documented in the international finance literature. Analyzing of co-movements between stock markets has become an attractive issue especially for portfolio managers concerning the international portfolio diversification and also for policy makers concerning the stability of the financial system. It is commonly known that in case of high correlations between the stock returns the potential gain from international diversification is reduced, since in such a case a loss in one market is likely to be accompanied by a loss in other market (see e.g. Syllignakis and Kouretas (2011)). On the other hand, if the level of returns' correlation is low, the investors are encouraged to invest to such markets in order to exploit the potential diversification benefits. Very interesting issue is also to study the relationships between the conditional correlation and conditional volatility. Longin and Solnik (1995) presented several reasons (presence of a time trend, threshold and asymmetry) why correlations between stock markets are not constant over time and they furthermore showed that changes in correlations can be explained by changes in conditional covariance. Cappiello et al. (2006) and Gjika and Horvath (2012) pointed out the fact and proved that the stock market conditional volatility and correlation are positively related.¹ The whole analysis in this paper was mainly inspired by papers of Syllignakis and Kouretas (2011) and Gjika and Horvath (2012) who analyzed relationships between conditional volatility and conditional correlation for CEE countries based on weekly data during the period 1997-2009 and daily data during 2001-2011, respectively.

This paper analyzes the relationships between the dynamic conditional correlation and conditional volatility for the selected CEE markets (Czech Republic, Hungary, Poland) and the

¹ From the space reasons we do not provide the survey of literature dealing with the DCC in CEE countries. An excellent survey of literature can be found e.g. in Syllignakis and Kouretas (2011).

Western European stock market represented by stock market of Germany and France, respectively, as well as the relationship between German and French market and between individual CEE markets for weekly data during the period 2003-2013. The impact of the higher volatility during the period October 17th, 2008 – December 25th, 2009 is also analyzed. The structure of the paper is as follows: section 2 deals with data, section 3 contains the methodological issues and empirical results, section 4 concludes.

2 DATA

The analyzed data set contains weekly data of stock price indices of CEE countries - the Czech PX, Hungarian BUX, Polish WIG20 and two Western European stock indices - the German DAX and French CAC40. The analyzed time period spans from January 3rd, 2003 to January 3rd, 2014 (i.e. 575 observations for each index), the data were retrieved from the web-page <http://stooq.com> and the analysis was carried out in econometric software EViews.²

Table 1: Descriptive statistics of logarithmic stock returns and unconditional correlations

	BUX	PX	WIG	DAX	CAC
Mean	0,151860	0,132428	0,119699	0,197812	0,051615
Std. Dev.	3,562397	3,311555	3,247232	3,207019	3,043438
Skewness	-0,978616	-1,549669	-0,397702	-0,953029	-1,293369
Kurtosis	10,21027	17,57873	5,867259	10,93746	12,19645
Jarque-Bera	1332,674***	5303,720***	211,3854***	1590,943***	2178,974***
<i>Unconditional correlations</i>					
BUX	1,000000	0,714319	0,676988	0,593688	0,620141
PX		1,000000	0,682225	0,645627	0,676240
WIG			1,000000	0,609298	0,598369
DAX				1,000000	0,923446
CAC					1,000000

Source: Own calculation in econometric software EViews.

Note: In the whole paper the symbols ***, **, * denote the rejection of the H_0 hypothesis at significance level 1%, 5% and 10%, respectively.

The analysis is based on logarithmic stock returns³ the descriptive statistics (mean, standard deviation, skewness coefficient, kurtosis coefficient, the Jarque-Bera normality test statistics) of which are summarized in Table 1. All the analyzed markets are relatively equally volatile (around 3%), the return series are negatively skewed and leptokurtic, the normality hypothesis can be rejected. Table 1 reports also the pair-wise unconditional correlations between all pairs of stock returns. The highest correlation can be observed between DAX and CAC40 stock returns, the correlations of the individual CEE countries' stock returns with the DAX and CAC40, respectively vary between 0,593 and 0,676. Correlations between pairs of CEE countries' stock returns are slightly higher and vary between 0,677 and 0,714.

3 METHODOLOGICAL ISSUES AND EMPIRICAL RESULTS

In order to assess the relationship between the conditional volatility and conditional correlation, we will briefly describe the idea behind the estimation of conditional correlation via multivariate DCC-GARCH models and thereafter we will concentrate on estimation of the relationship between the conditional correlations and conditional volatilities.

² Program for estimation of DCC model was written with the help of advice provided on the web-page <http://forums.eviews.com/>

³ The logarithmic stock returns in time t are calculated as differences between the logarithmic stock price in time t and logarithmic stock price in time $t-1$ and thereafter multiplied by 100%.

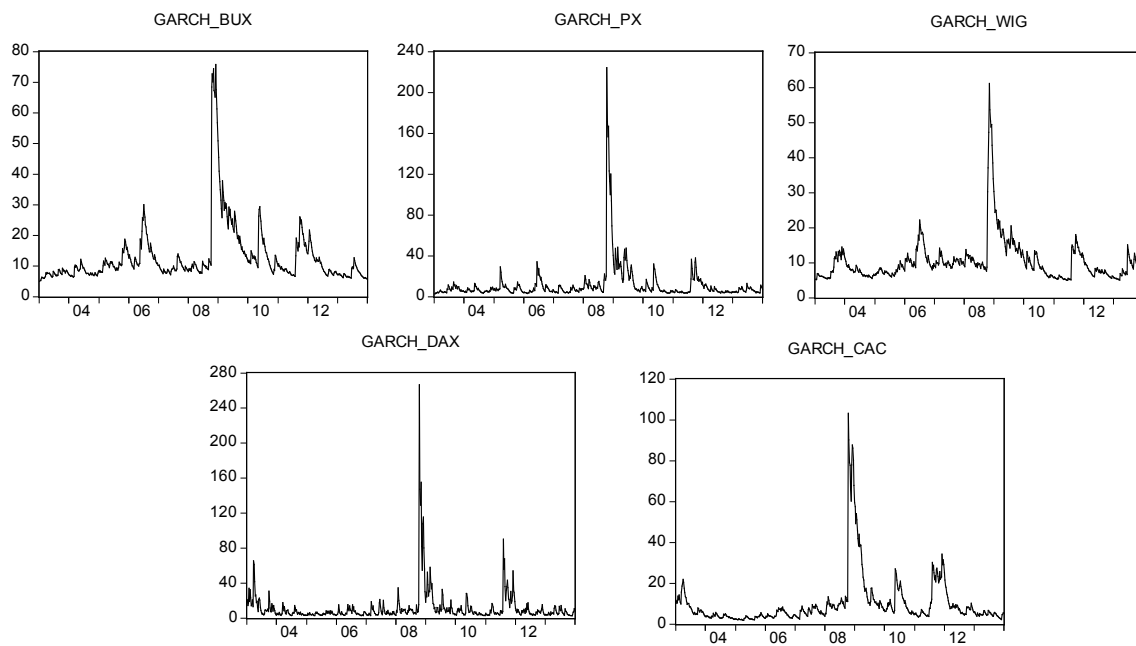

Figure 1: Conditional volatilities (i.e. conditional variances) of individual return series
Source: Own calculation in econometric software EViews.

Estimation of the DCC-GARCH model is carried out in two steps – in the first step the appropriate univariate GARCH model is to be estimated⁴ and after diagnostic checking of standardized residuals from this model, it follows the estimation of the DCC model⁵. In analysis conducted in this paper all parameters of the univariate GARCH models were statistically significant at 1% level of significance (the only exception was the intercept in case of CAC stock returns)⁶, the standardized residuals were uncorrelated, but non-normally distributed (i.e. the estimates are consistent only as quasi-maximum likelihood estimates - see e.g. Franses and Dijk (2000)). Estimated conditional volatilities for all individual return series are graphically depicted in Figure 1. From these graphs it is apparent that the conditional volatility was very high after the outbreak of the financial crisis in the half of October 2008 and returned to the pre-crisis levels around the end of 2009.

Conditional correlations for all pairs of individual return series are plotted in Figure 2. It is worth noting that the highest correlations in almost all cases (with exception of DCC_WIG_DAX and DCC_BUX_PX) occurred in the week of October 17th, 2008. The highest correlations in case of DCC_WIG_DAX and DCC_BUX_PX were reached in the week of May 25th, 2012 and October 7th, 2011, respectively. Conditional correlations significantly above the average values were recorded in the second half of the 2011 almost in all analyzed cases and one of the possible explanations is given by Baumöhl (2013) who speaks about the „fears that the sovereign debt crisis would spread”.

⁴ For more information and details about GARCH model see e.g. Franses and Dijk (2000). In this paper we used the univariate GARCH model of Bollerslev (1986), but in general it is possible to use different univariate ARCH-type models for individual return series (the selection is typically based on the use of BIC - see e.g. Capiello et al. (2006), Gjika and Horvath (2012)).

⁵ For more information about DCC model see e.g. Baumöhl (2013), Wang and Moore (2008).

⁶ Complete results are available from author upon request.

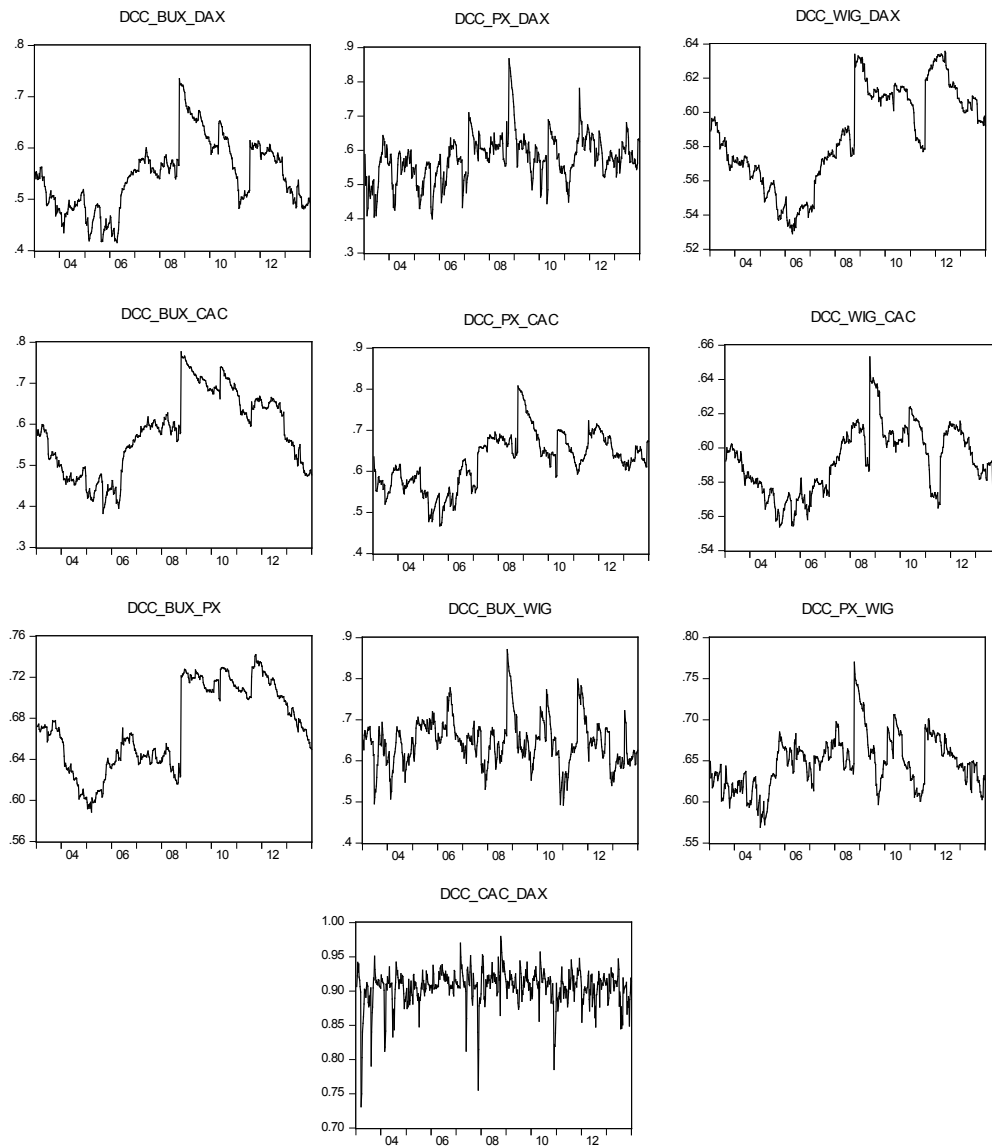

Figure 2: Dynamic conditional correlations between all analyzed pairs of logarithmic stock returns
Source: Own calculation in econometric software EViews.

In the next step we also examined the relationship between conditional correlations and conditional volatilities based on following regression (see e.g. Syllignakis and Kouretas (2011))⁷:

$$\rho_{ij,t} = \omega + \beta_i h_{i,t} + \beta_j h_{j,t} + \varepsilon_{ij,t} \quad (1)$$

where $\rho_{ij,t}$ is the estimated pair-wise conditional correlation coefficient between the stock returns of markets i and j . Symbols $h_{i,t}$ and $h_{j,t}$ denote the conditional volatility of the market i and j , respectively. Positive value of β_i indicates that conditional correlations between the market i and j rise with the volatility of the market i , whereas negative value of β_i means that the correlations between the return series of market i and market j fall in periods of high volatility in the market i . We also try to assess the regression concerning the dummy variable dum_t taking the value of 1 in the period of higher conditional volatility (October 17th, 2008 – December 25th, 2009), i.e.

⁷ Syllignakis and Kouretas (2011) and Gjika and Horvath (2012) did the analyzes also using the rolling stepwise regressions.

$$\rho_{ij,t} = \omega + \beta_i h_{i,t} + \beta_j h_{j,t} + \alpha_0 dum_t + \alpha_i dum_t h_{i,t} + \alpha_j dum_t h_{j,t} + \varepsilon_{ij,t} \quad (2)$$

where α_0 denotes the shift in the level of DCC during the above mentioned period, positive values of α_i and α_j indicate the rise of conditional correlations between the market i and j with the rise of volatility of the market i and j , respectively during the period October 17th, 2008 – December 25th, 2009. In the same time period the negative values of α_i and α_j indicate the fall of conditional correlations between the return series of market i and market j caused by rising volatility in the market i and j , respectively. The estimated parameters of the equation (2) are summarized in Table 2.

Table 2: Estimated parameters of the equation (2)

i j	BUX DAX	PX DAX	WIG DAX	CAC DAX	BUX CAC	PX CAC	WIG CAC	BUX PX	BUX WIG	PX WIG
ω	0,486 ***	0,532 ***	0,594 ***	0,899 ***	0,505 ***	0,578 ***	0,578 ***	0,634 ***	0,543 ***	0,605 ***
β_i	0,003 ***	0,003 ***	-0,002 ***	4.10^{-4}	-0,001	-0,001 ***	-3.10^{-4}	0,004 ***	0,006 ***	0,001 ***
β_j	0,001 ***	0,001 *	0,001 ***	2.10^{-4}	0,009 ***	0,007 ***	0,002 ***	-0,001 ***	0,004 ***	0,004 ***
α_0	0,127 ***	0,028 ***	0,011	0,006	0,185 ***	0,078 ***	0,024 ***	0,075 ***	-1.10^{-5}	0,013
α_i	-0,001 *	-0,002 ***	0,003 ***	-4.10^{-4}	0,002	0,001 **	2.10^{-4}	-0,004 ***	-0,002 **	-0,001 *
α_j	-0,001 ***	-0,001 *	-0,001 ***	1.10^{-4}	-0,009 ***	-0,005 ***	-0,001 ***	0,001 **	-0,004 ***	-0,002 **

Source: Own calculation in econometric software EViews.

Concerning the statistical significance of the estimated parameters, the DCC of individual CEE return series with the Western European return series (DAX and CAC40) rise as a result of growing volatility of Western European returns (positive values of β_j), whereas during the period October 17th, 2008 – December 25th, 2009 the decline in DCC was recorded as a reaction to the rising volatility of DAX and CAC40, respectively (negative values of α_j). The impact of volatilities in CEE countries on DCC values was not so clear (statistically significant positive and negative values of β_i and α_i as well as in some cases non-significant parameters' values). Taking into account the DCC values between the pairs of CEE countries, it is also not possible to adopt a clear conclusion, whereas in case of DCC_DAX_CAC the impact of volatility on conditional correlation was definitely not confirmed.

4 CONCLUSION

In this paper we examined the DCC between the selected CEE markets (Czech Republic, Hungary, Poland) and the Western European stock market (Germany, France), as well as between individual CEE stock returns and between German and French stock returns. The main aim was to analyze the relationship between DCC and conditional volatility and it was assessed concerning the impact of the higher volatility during the period October 17th, 2008 – December 25th, 2009. It was proved the clear impact of conditional volatilities in German and French market, respectively on the DCC of individual CEE countries with the German and French market respectively. No impact of conditional volatilities on DCC values was detected for the pair Germany-France. Not so clear results were received for the pairs of CEE countries' returns.

Acknowledgements: This work was supported by the Grant Agency of Slovak Republic - VEGA grant No. 1/0595/11 “Analysis of Business Cycles in the Economies of the Euro Area (with Regards to the Specifics of the Slovak Economy) Using Econometric and Optimization Methods” and VEGA grant No. 1/0285/14 “Regional modelling of the economic growth of EU countries with concentration on spatial econometric methods“.

References

- [1] Baumöhl, E. (2013) *Stock market integration between the CEE-4 and the G7 markets: Asymmetric DCC and smooth transition approach*, [Online], Available: <http://mpira.ub.uni-muenchen.de/43834/> [11 Feb 2014].
- [2] Bollerslev, T. (1986) ‘Generalized Autoregressive Conditional Heteroskedasticity’, *Journal of Econometrics*, vol. 31, pp. 307-327.
- [3] Cappiello, L., Engle, R.F. and Sheppard, K. (2006) ‘Asymmetric Dynamics in the Correlations of Global Equity and Bond Returns’, *Journal of Financial Econometrics*, vol. 4, no.4, pp. 537-572.
- [4] Franses, P.H. and van Dijk, D. (2000) *Non-Linear Time Series Models in Empirical Finance*, Cambridge: Cambridge University Press.
- [5] Gjika, D. and Horvath, R. (2012) *Stock Market Comovements in Central Europe: Evidence from Asymmetric DCC Model*, [Online], Available: <http://wdi.umich.edu/files/publications/workingpapers/wp1035.pdf> [11 Feb 2014].
- [6] Hančlová, J. (2008) ‘Comparative Properties of Structural Macroeconomic Modelling’, *Quantitative Methods in Economics: Multiple Criteria Decision Making XIV – Conference Proceedings*, The Slovak Society for Operations Research Conference, High Tatras, pp. 70-75.
- [7] Longin, F. and Solnik, B. (1995) ‘Is the correlation in international equity returns constant: 1960–1990?’, *Journal of International Money and Finance*, vol. 14, pp. 3-26.
- [8] Syllignakis, M. N. and Kouretas, G. P. (2011) ‘Dynamic correlation analysis of financial contagion: Evidence from the Central and Eastern European markets’, *International Review of Economics and Finance*, vol. 20, no. 4, pp. 717-732.
- [9] Szomolányi, K., Lukáčik, M. and Lukáčiková, A. (2013) ‘Estimation of the Production Function Parameters in V4 Economies’, *Mathematical Methods in Economics 2009 – Conference Proceedings* (part II), The Czech Society for Operations Research Conference, Jihlava, pp. 898-902.
- [10] Wang, P. and Moore, T. (2008) ‘Stock Market Integration for the Transition Economies: Time-Varying Conditional Correlation Approach’, *The Manchester School*, vol. 76, no. 1, pp. 116-133.
- [11] *EViews forums*, [Online], Available: <http://forums.eviews.com/> [30 Nov 2013]
- [12] *Stooq*, [Online], Available: <http://stooq.com> [11 Feb 2014].

Author’s address

Ing. Michaela Chocholatá, PhD.

University of Economics in Bratislava, Faculty of Economic Informatics, Department of Operations Research and Econometrics

Dolnozemska 1/b, 852 35 Bratislava

Slovak Republic

email: michaela.chocholata@euba.sk

CONSUMPTION SMOOTHING AND RISK SHARING ACROSS THE REGIONS (FISCAL EFFECTS PANEL DATA APPROACH)

*Zlatica Ivaničová, Filip Ostrihoň,
University of Economics in Bratislava*

Abstract

The economic adjustment process of regions is influenced by three main mechanisms: flexible labour market, fiscal risk sharing and risk sharing via capital market. All mentioned mechanisms mitigate consumption effects of asymmetric income shocks. However, the labour market is in general quite rigid and fiscal risk sharing almost not used as a competence of fiscal policy. Therefore the economic adjustment may not occur for all of the regions.

The paper is aimed to empirically test the presence of asymmetric risk sharing among Slovak regions and its effect on consumption smoothing in panel econometric framework. Similar approach was employed for the Eurozone by Zemanek (2010), verifying the significance of capital flows on the asymmetric risk sharing. In this context we test the presence of intra-national, interregional risk sharing, by measuring the correlation of GDP growth and consumption growth of regions (NUTS 3 level). We further examine influence of relative GDP growth extracting the region specific uninsured risk of particular region relative to the average of other regions (using threshold variables).

Keywords: *Interregional risk sharing, consumption smoothing, fixed effects model, asymmetries*

JEL Classification: C23, E22, E32, R15

AMS Classification: 62P20, 91B42, 91B64

1 INTRODUCTION

Presented paper is intended to examine the intra-national, interregional consumption smoothing by applying the methodology for international risk sharing to the Slovak regional data. On the international level the adjustment process of countries and territories is mainly influenced by three key mechanisms. Namely the tools are flexible labour market, fiscal risk sharing and risk sharing through capital markets. Of all three the risk sharing through capital flows may be viewed as most robust towards governmental interference and mostly dependant on individual agents.¹ Therefore the paper takes additional focus on the possibilities of capital market for the consumption smoothing both on international and interregional level.

The main focus of the paper is to provide empirical evidence whether consumption smoothing occurs also on the regional level of Slovakia in regard to the interregional risk sharing. It is expected that the risk sharing is present among Slovak regions, since Slovakia is a unitary state, with long common development of the regions and many channels for possible risk sharing. Nevertheless slow regionalisation of governmental power and growing disparities among the regions may have endangered such bond.

To verify stated assumption a panel data econometric framework has been employed. There are several examples of econometric modelling of regions in Slovakia², as well as of work with panel data both by domestic (Surmanová – Furková, 2006) and foreign authors (Hančlová, 2012), which mostly dealt with examination on national level. According to the authors'

¹ Such statement is made assuming the conditions of European Union, which proclaims free movement of labour and capital over its territory. Labour can be viewed as more rigid than capital, since its movement depends on other factors such as skills, language, nationality etc.

² See e.g. Domonkos – Radvanský (2010), Chocholatá (2013).

information, so far there has not been a study concerning the consumption smoothing in the context of interregional risk sharing in the conditions of Slovakia.

The first part of the paper is dedicated to the capital market as a tool for both international and interregional risk sharing. Because of insufficient data support considering the capital flow an econometric approach using dummy variables has been suggested in the next section. Third section contains the results for the application of the methodology described in second section on the panel data for Slovak regions on NUTS 3 level. The last section summaries the obtained results and draw implications concerning risk sharing across Slovak regions.

1.1 Role of capital market in risk sharing

Capital market is considered in the literature as the third possible regulatory instrument for balancing the efficiency of economies in the monetary union. It should be noted that the permanent capital assets' inflow from northern countries of European monetary union to its southern part, namely from Germany to Greece, Portugal and Spain, creates an asymmetric allocation of capital. Asymmetric allocation of capital assets leads to asymmetric international risk sharing, which limits the international risk sharing in the euro area. It is becoming a key issue in the smoothing-out process and in the overall stability of the euro area.

International risk sharing principle and the adjustment mechanism in the monetary union were first proposed by Mundell (1973). Mundell proposed that the monetary union should increase the integration of capital markets. He argued that the impact of cross-country capital assets is one of the tools for effective development of economies and consumption smoothing in the individual countries of euro area. Portfolio diversification of the capital assets would provide a mechanism of risk sharing among the countries and the asymmetric shocks of income and consumption should be compensated by changes in the capital assets income and capital assets evaluation.

1.2 Model of asymmetric international risk sharing mechanism

Mundell (1973) investigates in his textbook the international risk sharing. He assumed a symmetric cross-country holding of capital assets among countries relative to their economic size. In the context of risk sharing mechanism two channels of income distribution were described.

- First – direct distribution channel. Dividends on capital support boom, respectively suppress recession during the swings of economic cycle. In the boom a country has to pay more dividends on its foreign liabilities (inflow capital), but receives less investment income from its investments (outflow capital) in the recession, and vice versa.
- Second – capital evaluations are an indirect distribution channel. In the case of the boom (recession), the value of shares and immovable property may rise (fall). However, it is not clear if the rate of these values, profits or losses will affect income. It depends whether the evaluated income or loss is immediately implemented or if evaluated loss affects income in the form of remission of the debt.

Capital flows among countries in the euro area exhibited a significant asymmetry. Accordingly the international risk sharing became also asymmetric. For comparison the effect of symmetric versus asymmetric diversification of international risk a basic model of consumption smoothing for a two-country monetary union, which assumes full business cycles, was formulated. The detailed model was formulated in the paper “Asymmetric International Risk Sharing in the Euro Area” by Zemanek (2010). The analysis of consumption smoothing and asymmetric foreign capital asset distribution was done for the whole euro-area and individual member states.

In the case of abstracting the economic cycle we will describe the basic idea of the model for two regions (i, j). Consumption in both regions depends on their own gross national income (Y) and

net cross-border capital flow (net investment income). The international risk sharing mechanism distributes gross national income between the two countries. The net investment income for i -th country³ is equal $(ra^jY_t^j - ra^iY_t^i)$, where r is the constant yield from investment in time t , a^i is the size of assets measured as share of foreign gross national income (j -th country) Y_t^j in time t , and a^j is the size of assets measured as share of foreign liabilities on the domestic gross national income (i -th country) Y_t^i in time t . Similarly we can formulate the net investment income for j -th country as $(ra^jY_t^i - ra^iY_t^j)$. On the basis of previous formulation, the consumption in i -th country in time t can be expressed as $C_t^i = Y_t^i + r(a^iY_t^j - a^jY_t^i)$ and in j -th country in time t as $C_t^j = Y_t^j + r(a^jY_t^i - a^iY_t^j)$ respectively.

More interesting research is focused on the analysis of trend in consumption. From this reason we will modify the above mentioned model.

If we assume that the rate of growth of consumption in the i -th country at time t (ΔC_t^i) ⁴ depends on the growth rate of its own GDP (ΔY_t^i) at time t and share of net income from the growth rate of cross-border capital in the i -th and j -th country in time t , we can formulate following relation:

$$\Delta C_t^i = \Delta Y_t^i + r(a^i \Delta Y_t^j - a^j \Delta Y_t^i) \quad (1)$$

An interesting modification of the model takes into consideration various rates of dividends:

$$\Delta C_t^i = \Delta Y_t^i + [(r^j a^i \Delta Y_t^j) - (r^i a^j \Delta Y_t^i)] \quad (2)$$

From the point of view of long-term development it is interesting to distinguish the rate of dividends considering the investigated years and business cycles respectively. Because of the problems with the data of net income from cross-border capital, the above formulated model was simplified.

1.3 Possibilities of using ideas of mentioned theory to analyse Slovak regions

As was indicated in the beginning of section 1, capital market can be a significant tool for the risk sharing not only on national level but also on regional level. We see its main advantage compared to the other two mentioned mechanisms (labour market and fiscal policy) in that possibly the key competence for the decision over fostering the risk sharing is on the individual economic agent instead of the government itself, although the government may significantly affect it as well.

The idea is that similar risk sharing process through capital inflow and outflow occurs also at intraregional level. Despite the fact that Slovak stock exchange is not utilized as a tool for capital allocation, the capital flow should be also present for Slovak regions, where there are no restrictions for starting businesses in region which is not of agents permanent residence. Agents can therefore channel the capital into economically more active regions and on the other hand smooth the consumption in the region of their residence.

Despite a reasonable expectation of interregional risk sharing via capital flow, such assumption cannot be verified through econometric methods, since there are no data for regional capital inflow or outflow. Therefore we have focused only on the presence of consumption smoothing. Conclusively we cannot empirically verify whether the capital flow is the only significant

³ Each country has capital income from its foreign assets in the other country (payment in - yield from capital outflow) and has to pay dividends on foreign liabilities (payment out - yield from capital inflow).

⁴ Where $\Delta C_{i,t} = \ln(C_{i,t}) - \ln(C_{i,t-1})$ and similar holds for $\Delta Y_{i,t}$.

mechanism for assuring interregional risk sharing, since labour market and fiscal policy are very probable to play a greater role on the regional level than on international level.

2 THEORETICAL SPECIFICATION FOR EMPIRICAL ANALYSIS OF SLOVAK REGIONS

Unbalanced development of consumption, investment and GDP induces in different regions of Slovak economy permanent opening of the gap in living standards of inhabitants. The model which allows the analysis of relation between consumption and GDP was formulated by Zemanek (2010) in form:

$$(\Delta C_{i,t} - \Delta C_{SE,t}) = \beta_1 (\Delta Y_{i,t} - \Delta Y_{SE,t}) \quad (3)$$

Where $\Delta C_{i,t}$ is per capita growth of consumption and $\Delta Y_{i,t}$ is per capita growth of GDP for the i -th region in time t . The subscript SE indicates average consumption per capita growth or average GDP per capita growth in Slovak economy. The parameter β_1 is defined as the percentage of uninsured risk in the Slovak economy.

If the parameter β_1 is zero then relative deviation of per capita in i -th region ($\Delta Y_{i,t} - \Delta Y_{SE,t}$) will not systematically affect relative per capita consumption growth ($\Delta C_{i,t} - \Delta C_{SE,t}$). That is the case of perfect risk sharing in the Slovak economy. On the other hand, if the parameter β_1 is equal to one, there is no risk sharing within the Slovak economy. The relative deviations of GDP growth rate are perfectly correlated with relative deviations of consumption growth rate. Hence, we can conclude that the expected value of the parameter take values β_1 from interval (0, 1).

2.1 Formulation of intraregional risk sharing model

For Slovak regions we will analyse panel data model, building upon work of Zemanek (2010), which analysed the consumption smoothing across euro area countries using panel data while taking into account the international investment position.

For the evaluation of interregional risk sharing for Slovak economy we have formulated the following standard panel equation with region specific fixed effects ρ_i , a constant β_0 and random component $u_{i,t}$ in the form:

$$(\Delta C_{i,t} - \Delta C_{SE,t}) = \beta_0 + \beta_{SE} (\Delta Y_{i,t} - \Delta Y_{SE,t}) + \rho_i + u_{i,t} \quad (4)$$

To estimate the parameters of equation (4) we have used a modification according to Sørensen et al. (2007). With the goal to model consumption smoothing across regions threshold dummy variables were included into the model (4). These variables enable the separation of the total uninsured risk β_{SE} to the region specific effect ($\beta_{T,i}$) and residual uninsured effect (β_1):

$$\beta_{SE} = \beta_1 + \beta_{T,i} D_i \quad (5)$$

Parameter $\beta_{T,i}$ indicates a region specific uninsured risk with T indicating the threshold dummy approach. D_i is a region specific dummy variable for i -th region. Its value is equal to 1 for investigated region and 0 for other regions. Substituting (5) into (4) gives the equation:

$$(\Delta C_{i,t} - \Delta C_{SE,t}) = \beta_0 + \beta_1 (\Delta Y_{i,t} - \Delta Y_{SE,t}) + \beta_{T,i} (\Delta Y_{i,t} - \Delta Y_{SE,t}) D_i + \rho_i + u_{i,t} \quad (6)$$

Equation (6) includes an interaction between regions. The interpretation of the parameters' changes was done by Hardy (1993). Parameters of estimated equation can be interpreted as follows:

- β_1 indicates the value of uninsured risk if D_i is equal 0, hence yielding the average uninsured risk for all regions but region i ,
- $\beta_{T,i}$ gives the number of units that β_1 changes if D_i becomes 1,
- $\beta_1 + \beta_{T,i}$ is the uninsured risk for region i .

On the basis of that interpretation, it is not possible to reject the hypothesis of identical risk sharing, if there is a significant parameter $\beta_{T,i}$, and thus, a significant variation in consumption smoothing between regions of Slovak economy.

3 DATA AND RESULTS

For the analysis of the risk sharing among Slovak regions historical data for eight regions on the NUTS 3 level (shire or “kraj”) were used. The data were available from 2001 to 2010 for each of the mentioned eight Slovak regions (Bratislava region, Trnava region, Trenčín region, Nitra region, Žilina region, Banská Bystrica region, Prešov region and Košice region), which, after making the first difference for periods, resulted in panel data set consisting of 72 observations. Average net monthly expenditures on consumption of a member of household were multiplied by twelve to approximate annual expenditures on consumption per capita in current prices. Annual gross domestic product (GDP) per capita in current prices was available without any need for adjustment. The source of the data is the regional database of Slovak statistical office (RegDat).

3.1 Testing for stationarity

Both dependent and independent variable of the model were tested for stationarity of used data. Given the panel data framework a common unit root test was employed (Levin, Lin and Chu, 2002), which assumes a common autoregressive process among all of the cross section units. To ensure that the mentioned assumption is not affecting the outcome of the tests we will verify the results by panel data modification of ADF test (Maddala and Wu, 1999) and PP test (Choi, 2001), which assume individual autoregressive processes.⁵ The results for null hypothesis of unit root for examined variables are presented in the table 1.

Table 1: Panel Unit Root tests (for the period 2002 – 2010)

	Panel unit root tests (p-values)		
	Levin – Lin – Chu test	Panel ADF test	Panel PP test
$\Delta C_{i,t} - \Delta C_{SE,t}$	0.000	0.000	0.000
$\Delta Y_{i,t} - \Delta Y_{SE,t}$	0.000	0.000	0.000

Source: Authors' computation via EViews based on particular RegDat data.

Presented p-values were estimated based on one lag difference term and no exogenous regressor specification for Levin – Lin – Chu (LLC) test and panel ADF test (which is the number of lags also selected by automatic selection methods based on Schwartz and Hannan – Quinn information criterion), and no exogenous regressor specification for panel PP test. Further Bartlett kernel method and automatic bandwidth selection based on the Newey – West method was selected for kernel weighting of LLC test and panel PP test.

Described specification was considered most appropriate, since lag difference above one either rendered the test non-functional⁶ or resulted in significantly different results of the test, which we associated with the low number of observations in each cross-section. Therefore we consider

⁵ For more detailed description of autoregressive processes and models see e.g. Rubliková – Prihodová (2008).

⁶ Test could not be computed for trend and intercept specification for lag order two and every specification for lag order three or higher.

higher order of lag difference irrelevant. Different specification for exogenous regressors yield similar results to those stated in the table 1 for all the tests except panel ADF test, which implied nonstationarity for individual trend and intercept specification.

3.2 Testing the consumption smoothing without the threshold variables

For the hypothesis of identical risk sharing across the regions the specification (4) assumed correlation of GDP growth and consumption growth, which was subsequently estimated on the historical panel data for the period 2002 – 2010. According to the Hausman test (1978) for the appropriate estimator for panel data model we cannot reject the null hypothesis of consistency of GLS estimator for random effects. Hence we have estimated the specification (4) both by using Swamy – Arora quadratic unbiased estimator for random cross-section effects and Least Square Dummy Variable (LSDV) estimator for fixed cross-section effect, which assigns a dummy variable to each cross-section unit. In both cases there is a strong evidence of serial correlation of residuals so we have chosen White robust coefficient estimator, which should produce standard errors robust to the effects of serial correlation.

Table 2: Estimates for the specification (4)⁷

	Random effects model	Fixed effects model
β_1	0.090411 (0.232591)	0.046612 (0.274474)
Constant	0.000733 (0.002809)	0.000617 (0.000730)
R^2	0.003725	0.022796
F static (p-value)	0.610534	0.992354
Durbin – Watson statistic	3.015601	3.086276

Source: Authors' computation via EViews based on particular RegDat data.

Based on the resulting estimates in table 2, disregard of the cross – section effects' nature the model is still insignificant according to the p-values of F statistic. Although the overall explanatory performance of the random effects model is greater than the fixed effects model, it is still very small. The conclusion of joint insignificance is supported by the results of the t - test, based on which all of the parameters are statistically insignificant on 10% significance level. Furthermore according to the F - test for joint significance of fixed effects in the fixed effects model, the effects were insignificant. Therefore we may conclude that deviations from the country average of regional consumption are not affected by the net deviations of GDP in a particular region, which can be interpreted as consumption smoothing, indicating a perfect risk sharing across Slovak regions during the examined period.

3.3 Testing the consumption smoothing with threshold variables

Augmented hypothesis assumes different region specific uninsured risks across Slovakia. To evaluate such assumption specification (6) was estimated on historical panel data for period 2002 – 2010. Although the Hausman test (1987) have confirmed the random effects model as appropriate for the panel data specification, due to the further use of dummy variables for region specific uninsured risk effects we will use fixed effects model to not mix the cross-section effects.⁸ Following the approach of Zemanek (2010) we examine the parameter for threshold variable or region specific uninsured risk for one region at a time. This way we are comparing the uninsured risk of particular region captured via threshold variable to the uninsured risks of the average of other regions in Slovakia. Such approach results in eight different models, one for each region and region specific uninsured risk (threshold variable), all of which were estimated

⁷ Particular White robust standard errors are presented in the parenthesis under the associated parameter.

⁸ The threshold dummy variables and the region specific fixed variables are technically the same, therefore we have decided to use fixed effects instead of random effects.

by the LSDV estimator. Again White robust coefficient estimator was used to ascertain standard errors robust to the serial correlation.

Table 3: Multiple estimates for specification (6), which include region specific threshold variable.⁹

	Bratislava region	Trnava region	Trenčín region	Nitra region
β_1	0.092730 (0.310681)	0.024541 (0.369181)	-0.008618 (0.303924)	0.041293 (0.289578)
β_T	-0.330062 (0.310681)	0.089865 (0.369181)	0.650721** (0.303924)	0.125174 (0.289578)
Constant	0.001148 (0.001211)	0.000439 (0.001470)	0.001006* (0.000558)	0.000637 (0.000690)
R^2	0.028253	0.023420	0.036502	0.023062
F static (p-value)	0.993285	0.996751	0.982622	0.996942
DW statistic	3.077945	3.082997	3.094458	3.083874
	Žilina region	Banská Bystrica region	Prešov region	Košice region
β_1	0.005137 (0.293053)	-0.188570 (0.271626)	0.199676 (0.241409)	0.163037 (0.246457)
β_T	0.849361*** (0.293053)	0.883398*** (0.271626)	-1.167363*** (0.241409)	-2.830289*** (0.246457)
Constant	-0.000303 (0.001059)	0.001580*** (0.000234)	-0.000208 (0.000387)	-0.005355*** (0.000108)
R^2	0.036759	0.086325	0.087493	0.154464
F static (p-value)	0.982176	0.749234	0.740894	0.277531
DW statistic	3.072427	3.010427	3.035745	3.017720

Source: Authors' computation via EViews based on particular RegDat data

The estimates verifying augmented hypothesis has also confirmed that for Slovakia as a unitary state the intraregional risk sharing is very close to perfect and therefore on average intraregional risk sharing produce almost perfect consumption smoothing. However the uninsured region specific risk, which is represented by the threshold variable, is statistically significant for 5 of the regions, namely Trenčín region, Žilina region, Banská Bystrica region, Prešov region and Košice region. In that sense the total uninsured risk for particular region is significant and there are hints of differences for consumption smoothing, which point on imperfections in the risk sharing among the Slovak regions. Such statement can be considered to be valid only for marginal cases, since for average of regions all estimated models have confirmed consumption smoothing across, as may be seen on the high p-value for the F - test, which is lowest for Košice region, but still insignificant.

Interesting is also the sign of parameter for threshold variable, since according to the Zemanek (2010), positive threshold variable parameter indicates worse consumption smoothing in the region than for the average of the other regions, while negative value indicates better consumption smoothing compare to the other regions. The magnitude of threshold variable parameters has to be still interpreted carefully since for each region the average of consumption smoothing of particularly not examined regions changes. Mutual comparison would therefore

⁹ Particular White robust standard errors are presented in the parenthesis under the associated parameter. The significance of parameter at 10%, 5% and 1% level is highlighted by *, ** and *** respectively.

have been biased since each of the regions has a different starting position. Based on the significant threshold variables we may still assume that for the Košice region and Prešov region the consumption smoothing is higher, than for the average of not examined regions, while for Trenčín region, Žilina region and Banská Bystrica region the consumption smoothing is lower, than for the average of not examined regions.

4 CONCLUSION

In the presented paper we have shown the possibilities of capital flows for the risk sharing and consequently consumption smoothing both on international and intraregional level. Despite that we were not able to extract the effect of capital flows on regional consumption smoothing, we have shown that for Slovak regions the consumption smoothing and consequently risk sharing does occur. The assumption was additionally confirmed by models incorporating region specific threshold variable. Threshold variables have also shown that there is statistically significant difference for consumption smoothing in 5 regions, namely Trenčín region, Žilina region, Banská Bystrica region, Prešov region and Košice region.

Although the overall significance for every model has confirmed the hypothesis of consumption smoothing for all of the regions, statistical significance of particular threshold variables indicates that the situation is not so straightforward and foreshadows possible future danger of asymmetric risk sharing across the regions, resulting in limitations of interregional consumption smoothing.

Acknowledgements: This paper is supported by the Grant Agency of Slovak Republic - VEGA, grant no. 1/0595/11 "Analysis of Business Cycles in the Economies of the Euro Area (with Regards to the Specifics of the Slovak Economy) Using Econometric and Optimization Methods" and grant no. 1/0285/14 "Regional modelling of the economic growth of EU countries with concentration on spatial econometric methods".

References

- [1] Chocholatá, M. (2013) 'Regional Convergence: A Spatial Econometric Approach', *Ekonomika a Informatika*, vol. 9, no. 2, pp. 85-95.
- [2] Choi, I. (2001) 'Unit Root Tests for Panel Data', *Journal of International Money and Finance*, vol. 20, pp. 249-272.
- [3] Domonkos, T. and Radvanský, M. (2010) 'Regional modeling at the Slovak academy of sciences', *Quantitative Methods in Economics: Multiple Criteria Decision Making XV – Conference Proceedings*, The Slovak Society for Operations Research Conference, Bratislava, pp. 15-22.
- [4] Surmanová, K. and Furková, A. (2006) 'Does the Entrance of the Country into European Union Influence an Inflation Convergence?', *Quantitative Methods in Economics: Multiple Criteria Decision Making XIII – Conference Proceedings*, The Slovak Society for Operations Research Conference, Bratislava, pp. 176-181.
- [5] Hančlová, J. (2011) 'Panel Modelling of Globalization for the Selected New EU Countries', *LEF 2011 – Conference Proceedings*, 10th International Conference of Technical University of Liberec, Liberec, pp. 161-170.
- [6] Hardy, M.A. (1993) *Regressions with Dummy Variables*, Newbury Park: Sage.
- [7] Hausman, J. A. (1978) 'Specification Tests in Econometrics', *Econometrica*, vol. 46, pp. 1251-1272.
- [8] Levin, A., Lin, C. F. and Chu, C. (2002) 'Unit Root Tests in Panel Data: Asymptotic and Finite-Sample Properties', *Journal of Econometrics*, vol. 108, pp. 1-24.
- [9] Maddala, G. S. and Wu, S. (1999) 'A Comparative Study of Unit Root Tests with Panel Data and A New Simple Test', *Oxford Bulletin of Economics and Statistics*, vol. 61, pp. 631-652.
- [10] Rublíková, E. and Príhodová, I. (2008) *Analýza vybraných časových radov-ARIMA modely*, Bratislava: Ekonom.

- [11] Sørensen, B. E., Wu, Y.T., Yosha, O. and Zhu, Y. (2007) 'Home Bias and International Risk Sharing: Twin Puzzles Separated at Birth', *Journal of International Money and Finance*, vol. 26, pp. 587-605.
- [12] Zemanek, H. (2010) Asymmetric International Risk Sharing in the Euro Area, 5th Workshop Makroökonomik und Konjunktur, [Online], Available: http://www.cesifo-group.de/de/dms/ifodoc/docs/event/Conferences/conf_nd/2010-11-18-Fifth-Workshop-MacroeconomicsandBusinessCycle/work-makro5-zemanek-h__14407557_en.pdf
[10 Mar 2014]

Author's address

Prof. Ing. Zlatica Ivaničová, PhD.

University of Economics in Bratislava, Faculty of business informatics, Department of Operations research and Econometrics

Dolnozemska 1/b, 852 35 Bratislava

Slovak Republic

email: zlatica.ivanicova@euba.sk

Ing. Filip Ostrihoň

University of Economics in Bratislava, Faculty of business informatics, Department of Operations research and Econometrics

Dolnozemska 1/b, 852 35 Bratislava

Slovak Republic;

email: filip.ostrihon@euba.sk

COMPARISON OF RANKING METHODS IN TWO-STAGE SERIAL DEA MODELS

Josef Jablonský
University of Economics, Prague

Abstract

Data envelopment analysis (DEA) is a non-parametric technique for evaluation of relative efficiency of decision making units characterized by multiple inputs and outputs. An interesting modification of conventional DEA models are models with network structure. The paper presents a modified SBM model for analysis of two-stage serial production systems. The results given by the SBM model are compared to other two models – Kao and Hwang and Chen model. Numerical experiments are realized on the original data set of 24 Taiwanese insurance companies presented in [5].

Keywords: data envelopment analysis, two-stage model, SBM model, efficiency, ranking

JEL Classification: C44

AMS Classification: 90C15

1 INTRODUCTION

Conventional DEA models as they have been formulated in [5] and [2] measure the efficiency of transformation of multiple inputs into multiple outputs in one production stage. The efficiency score of the decision making unit (DMU) under evaluation is defined as the weighted sum of outputs divided by the weighted sum of inputs with weights u_k , $k = 1, 2, \dots, r$, and v_i , $i = 1, 2, \dots, m$, respectively. Let us suppose that the set of decision making units (DMUs) contains n elements and the DMUs are evaluated by m inputs and r outputs with input and output values x_{ij} , $i = 1, 2, \dots, m$, $j = 1, 2, \dots, n$ and y_{kj} , $k = 1, 2, \dots, r$, $j = 1, 2, \dots, n$, respectively. The conventional envelopment DEA model originally formulated in [3] is as follows:

maximize

$$\theta_q = \frac{\sum_{k=1}^r u_k y_{kq}}{\sum_{i=1}^m v_i x_{iq}},$$

subject to

$$\frac{\sum_{k=1}^r u_k y_{kj}}{\sum_{i=1}^m v_i x_{ij}} \leq 1,$$

$$v_i \geq \varepsilon, u_k \geq \varepsilon,$$

(1)

where θ_q is the efficiency score of the DMU_q and ε is an infinitesimal constant. Model (1) is not linear in its objective function but can be easily re-written using Charnes-Cooper transformation into a linear program.

Let us suppose that the production process consists of two serial stages. The inputs of the first stage are transformed into its outputs and all or at least some of these outputs are utilized as inputs of the second stage that are used for production of final outputs. Let us denote the input

values of the first stage $x_{ij}, i = 1, 2, \dots, m, j = 1, 2, \dots, n$ and the output values of the first stage that serve as inputs of the second stage as $y_{kj}, k = 1, 2, \dots, r, j = 1, 2, \dots, n$. The independent final outputs of the first stage are $y'_{gj}, g = 1, 2, \dots, t, j = 1, 2, \dots, n$. Similarly, independent inputs of the second stage can be denoted as $y''_{hj}, h = 1, 2, \dots, s, j = 1, 2, \dots, n$ and final outputs of the second stage (final outputs of the production process) are $z_{lj}, l = 1, 2, \dots, p, j = 1, 2, \dots, n$. The general two-stage production process is presented in Figure 1.

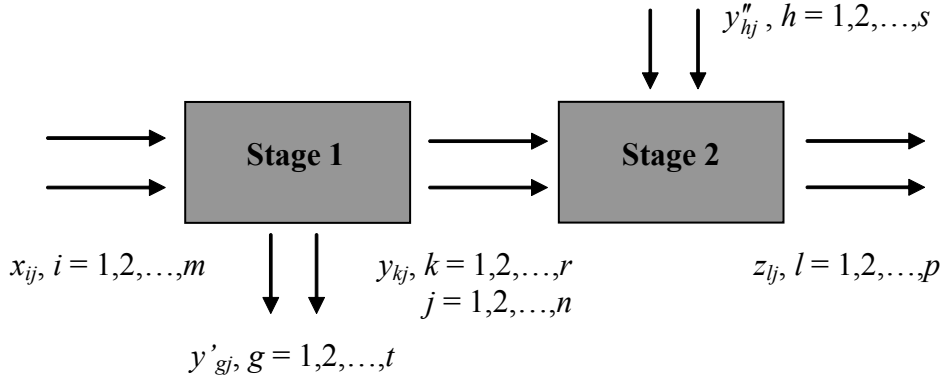

Figure 1: General two-stage serial production process.

The paper deals with two-stage serial DEA models. Next section contains formulation of several models of the mentioned class including the SBM models that is based on Tone’s SBM model and extend his formulation by some other additional features. Section 3 illustrates advantages and disadvantages of presented models on a numerical example of 24 insurance companies in Taiwan. Final section of the paper contains conclusions and discusses possibility of future research in this field.

2 TWO-STAGE SERIAL DEA MODELS

Two- and more generally multi-stage serial DEA models have been widely discussed by many researchers in the last ten years. Kao and Hwang model [5] and Chen model [4] belong among the most often applied ones. This section contains mathematical formulation of both models together with and extended SBM two-stage serial model. The further presented models suppose that the first stage has no independent outputs and the second stage has no independent inputs, i.e. $s = t = 0$.

Kao and Hwang model was formulated in 2008 in [5]. Below is its dual formulation with constant returns to scale assumption and input orientation:

Minimize

$$\theta_q$$

subject to

$$\sum_{j=1}^n x_{ij} \lambda_j \leq \theta_q x_{iq}, \quad i = 1, 2, \dots, m,$$

$$\sum_{j=1}^n y_{kj} \lambda_j - \sum_{j=1}^n y_{kj} \mu_j \geq 0, \quad k = 1, 2, \dots, r,$$

$$\sum_{j=1}^n z_{lj} \mu_j \geq z_{lq}, \quad l = 1, 2, \dots, p,$$

$$\lambda_j \geq 0, \mu_j \geq 0, \quad j = 1, 2, \dots, n,$$

(2)

where λ_j and $\mu_j, j = 1, 2, \dots, n$, are weights of the DMUs in the first and second stage, and θ_q is the efficiency score of the DMU $_q$. The efficiency measure of model (2) is always lower or equal to 1 and it is possible to prove simply that it is a product of efficiency measures of two single stages given by model (3) with constant returns to scales with the identical weights of intermediate characteristics - see e.g. [5] or [1]. Target values for inputs, intermediate characteristics and final outputs of the inefficient DMUs, i.e. characteristics of virtual units, can be given as linear (convex) combination of DMUs using their optimal weights λ_j^* and $\mu_j^*, j = 1, 2, \dots, n$. Output oriented version of this model is straightforward.

Another formulation of two-stage DEA model under constant returns to scale assumption is given in [4]. This formulation follows:

Minimize

$$\theta_q - \phi_q$$

subject to

$$\begin{aligned} \sum_{j=1}^n x_{ij} \lambda_j &\leq \theta_q x_{iq}, & i = 1, 2, \dots, m, \\ \sum_{j=1}^n y_{kj} \lambda_j &\geq \tilde{y}_{kq}, & k = 1, 2, \dots, r, \\ \sum_{j=1}^n y_{kj} \mu_j &\leq \tilde{y}_{kq}, & k = 1, 2, \dots, r, \\ \sum_{j=1}^n z_{lj} \mu_j &\geq \phi_q z_{lq}, & l = 1, 2, \dots, p, \\ \theta_q &\leq 1, \phi_q \geq 1, \\ \lambda_j \geq 0, \mu_j &\geq 0, & j = 1, 2, \dots, n. \end{aligned} \tag{3}$$

where λ_j and $\mu_j, j = 1, 2, \dots, n$, are weights of the DMUs in the first and second stage, θ_q and ϕ_q efficiency scores of the DMU $_q$ in the first and second stage and \tilde{y}_{kq} are variables to be determined. The DMU $_q$ is recognized as efficient by model (3) if the efficiency scores in both stages are $\theta_q = 1$ and $\phi_q = 1$ respectively, and the optimal objective value of the presented model is 0. Target values for inputs, intermediate characteristics and final outputs of the inefficient DMUs can be given in the same way as in the previous model. The inefficient units in model (3) can be ranked relatively e.g. by the following geometric average efficiency measure:

$$e_q = \left(\theta_q \frac{1}{\phi_q} \right)^{1/2}, \tag{4}$$

SBM two-stage serial model presented below combines advantages of conventional Tone's SBM model [8] and two-stage DEA model (3). This model with the assumption of constant returns to scale is as follows:

Minimize

$$\psi_q = \frac{1 - \frac{1}{m} \sum_{i=1}^m (s_i^- / x_{iq})}{1 + \frac{1}{r} \sum_{l=1}^r (s_l^+ / z_{lq})} \tag{5}$$

subject to

$$\sum_{j=1}^n x_{ij} \lambda_j + s_i^- = x_{iq}, \quad i = 1, 2, \dots, m, \quad (6)$$

$$\sum_{j=1}^n y_{kj} \lambda_j \geq \tilde{y}_{kq}, \quad k = 1, 2, \dots, r, \quad (7)$$

$$\sum_{j=1}^n y_{kj} \mu_j \leq \tilde{y}_{kq}, \quad k = 1, 2, \dots, r, \quad (8)$$

$$\sum_{j=1}^n z_{lj} \mu_j - s_l^+ = z_{lq}, \quad l = 1, 2, \dots, p, \quad (9)$$

$$(1 - \tau)y_{kq} \leq \tilde{y}_{kq} \leq (1 + \tau)y_{kq}, \quad k = 1, 2, \dots, r, \quad (10)$$

$$\lambda_j \geq 0, \mu_j \geq 0, s_k^+ \geq 0, s_i^- \geq 0.$$

where

s_i^- , $i = 1, 2, \dots, m$, is slack variable belonging to the i -th input,

s_l^+ , $l = 1, 2, \dots, p$, is surplus variable belonging to the l -th final output,

τ is the parameter that determines the rate of positive and negative deviations of values y_{kq} and \tilde{y}_{kq} (0.1 in numerical experiments presented in the next section of the paper), and

ψ_q is the total efficiency score of the DMU $_q$.

Constraints (6)-(9) correspond to the same set of constraints in model (3). Constraints (10) ensure that the variable \tilde{y}_{kq} differs from the original value of the k -th output by τ 100% at the most. The objective function of the model is the ratio of average relative slacks in the input space and average relative surplus variables in the output space. The unit under evaluation is efficient if all slack/surplus variables equal 0, i.e. the optimal objective function of the model is $\psi_q^* = 1$. Lower values indicate lower efficiency.

DEA models including network DEA models are often applied in economic practice. It is not possible to discuss all application fields. At least one can be mentioned – applications in banking, finance and insurance are numerous. An interesting survey of this kind of application can be found e.g. in [6] and [7]. A data set of 24 insurance companies will be used for illustration of presented models in the next section.

3 NUMERICAL EXAMPLE

In order to compare the results of the presented models, the data set of 24 insurance companies presented in [5] was used. Due to the limited space of the paper the original data set is not presented – it is given e.g. in [5]. The model contains two stages with two inputs (operational expenses and insurance expenses), two final outputs (underwriting profit and investment profit) and two intermediate characteristics (direct written premiums and reinsurance premiums). The first stage of the model measures efficiency of premium acquisition and the second stage evaluates profit efficiency.

Table 1 contains results given by models presented in previous section of the paper including rankings of DMUs (in parentheses). The following information are presented in this table:

Column (1) – efficiency score of the first stage given by CCR input oriented model.

Column (2) – efficiency score of the second stage given by CCR output oriented model. As the efficiency scores given by output oriented models are greater or equal 1, their reciprocal values are presented because it is more understandable for decision makers.

Column (3) – geometric average of efficiency scores in the previous two columns.

Column (4) – efficiency scores given by input oriented version of Kao and Hwang model (2).
 Column (5) – geometric average efficiency measures (4) based on the results of Chen model (3).
 Column (6) – results given by proposed SBM model (5)-(10) with parameter $\tau = 0.1$.

Table 1 Results of efficiency evaluation of the two-stage system

Company #	CCR-I	CCR-O	Geomean	Kao and	Chen	SBM
	1st stage	2nd stage	e_g	Hwang	model	model
	(1)	(2)	(3)	(4)	(5)	(6)
1	0.864 (8)	0.716 (7)	0.787 (6)	0.598 (5)	0.773 (5)	0.212 (12)
2	0.728 (13)	0.629 (10)	0.677 (10)	0.382 (11)	0.618 (11)	0.133 (19)
3	0.625 (17)	1.000 (1)	0.790 (5)	0.624 (3)	0.790 (3)	0.193 (14)
4	0.445 (24)	0.433 (16)	0.437 (24)	0.184 (22)	0.429 (22)	0.065 (22)
5	0.720 (15)	1.000 (1)	0.848 (3)	0.677 (2)	0.823 (2)	0.471 (2)
6	0.964 (6)	0.409 (18)	0.628 (12)	0.393 (8)	0.627 (8)	0.289 (9)
7	0.520 (21)	0.541 (13)	0.530 (19)	0.235 (17)	0.485 (17)	0.181 (15)
8	0.621 (18)	0.515 (15)	0.565 (16)	0.265 (15)	0.515 (15)	0.194 (13)
9	0.832 (10)	0.292 (23)	0.493 (21)	0.194 (21)	0.441 (21)	0.156 (17)
10	0.454 (23)	0.677 (9)	0.554 (17)	0.294 (13)	0.542 (13)	0.212 (11)
11	0.724 (14)	0.331 (22)	0.489 (22)	0.168 (23)	0.409 (23)	0.020 (23)
12	1.000 (1)	0.763 (6)	0.873 (2)	0.763 (1)	0.873 (1)	0.420 (5)
13	0.690 (16)	0.546 (12)	0.614 (14)	0.213 (19)	0.462 (19)	0.123 (21)
14	0.523 (20)	0.521 (14)	0.522 (20)	0.243 (16)	0.493 (16)	0.181 (16)
15	1.000 (1)	0.711 (8)	0.843 (4)	0.618 (4)	0.786 (4)	0.540 (1)
16	1.000 (1)	0.388 (19)	0.623 (13)	0.384 (9)	0.619 (9)	0.378 (6)
17	0.498 (22)	1.000 (1)	0.706 (8)	0.326 (12)	0.571 (12)	0.339 (7)
18	0.784 (11)	0.377 (20)	0.543 (18)	0.217 (18)	0.466 (18)	0.132 (20)
19	1.000 (1)	0.424 (17)	0.651 (11)	0.290 (14)	0.538 (14)	0.323 (8)
20	0.924 (7)	0.929 (5)	0.927 (1)	0.559 (7)	0.748 (7)	0.465 (3)
21	0.762 (12)	0.270 (24)	0.454 (23)	0.197 (20)	0.444 (20)	0.140 (18)
22	0.573 (19)	1.000 (1)	0.757 (7)	0.573 (6)	0.757 (6)	0.448 (4)
23	0.857 (9)	0.561 (11)	0.693 (9)	0.382 (10)	0.618 (10)	0.004 (24)
24	1.000 (1)	0.340 (21)	0.583 (15)	0.071 (24)	0.267 (24)	0.224 (10)

The presented results show that there are quite significant differences in efficiency measures of evaluated units in both stages – the units that are efficient or almost efficient in the first stage do not reach efficiency in the second stage and vice versa. Among all units there are not any that are efficient in both stages. Measuring the overall efficiency as the geometric average of particular efficiency scores of both stages among the best units DMU₂₀, DMU₁₂ and DMU₅ belong. It is interesting that the final ranking (and/or efficiency scores) of units given by this geometric average of both stages is very strong correlated with the same characteristics given by Kao and Hwang and Chen models. In the contrary, the results of the SBM model and other models are quite contradictory. This holds especially for units DMU₃ and the last two units in the set. The SBM model measures the efficiency level using slack and surplus variables of the inputs and final outputs, i.e. in a significantly different way than the other models. The differences in rankings of the both group of models should be explained in more detail and their detailed analysis is important for understanding of the whole production process.

4 CONCLUSIONS

Evaluation of efficiency of network production systems is a very complex task that can be solved using network DEA models. This class of models is widely discussed within professional community and many articles are published with a main focus on theoretical aspects and/or applications in this field. This paper is focused on a simplest system which is a two-stage serial

model. SBM two-stage serial DEA model is formulated and its results are verified on a real data set regarding evaluation of 24 insurance companies in Taiwan. Efficiency of companies is evaluated by two-stage model where the first stage takes into account acquisition efficiency and the second one profit efficiency. The results given by proposed SBM model are compared to results given by other two commonly used two-stage models. The conclusions given by applied models show quite significant differences in ranking of DMUs. It is difficult to explain the differences in results of the models but the efficiency scores given by proposed SBM model correspond to expectations given by results given by two single stages. Future research can be oriented on the more general network systems and their overall efficiency analysis.

Acknowledgements: The research is supported by the Czech Science Foundation, project no. P403/12/1387.

References

- [1] Ashrafi, A., Jaafar, A.B., Lee, L.S. and Abu Bakar, M.R. (2011) 'The efficiency measurement of parallel production systems: a non-radial DEA model', *Journal of Computer Science*, vol. 7, pp. 749-756.
- [2] Banker, R.D., Charnes, A. and Cooper, W.W. (1984) 'Some models for estimating technical and scale inefficiencies in data envelopment analysis', *Management Science*, vol. 30, pp. 1078-1092.
- [3] Charnes, A., Cooper, W. W. and Rhodes, E. (1978) 'Measuring the efficiency of decision making units', *European Journal of Operational Research*, vol. 2, pp. 429-444.
- [4] Chen, Y., Liang, L. and Zhu, J. (2009) 'Equivalence in two-stage DEA approaches', *European Journal of Operational Research*, vol. 193, pp. 600-604.
- [5] Kao, C. and Hwang, S.N. (2008) 'Efficiency decomposition in two-stage data envelopment analysis: An application to non-life insurance companies in Taiwan', *European Journal of Operational Research*, vol. 185, pp. 418-429.
- [6] Paradi, J.C., Rouatt, C. and Zhu, H. (2011) 'Two-stage evaluation of bank branch efficiency using data envelopment analysis', *Omega*, vol. 39, pp. 99-109.
- [7] Paradi, J.C. and Zhu, H. (2013) 'A survey on bank branch efficiency and performance research with data envelopment analysis', *Omega*, vol. 41, pp. 61-79.
- [8] Tone, K. (2002) 'A slack-based measure of super-efficiency in data envelopment analysis', *European Journal of Operational Research*, vol. 143, pp. 32-41.

Author's address

Prof. Ing. Josef Jablonský, CSc.

University of Economics, Prague, Faculty of Informatics and Statistics, Department of Econometrics

W. Churchill Sq. 4, 13067 Praha 3

Czech Republic

email: jablon@vse.cz

DISUTILITY RELEVANCE MODEL AND EFFECTIVENESS OF ALGORITHM FOR THE WEIGHTED P-MEDIAN PROBLEM

*Jaroslav Janáček, Marek Kvet,
University of Žilina*

Abstract

This contribution deals with the weighted p -median problem solving technique, which can be easily implemented within commercial IP-solver and which enables to solve huge instances of the problem originating in real transportation networks. Preliminary experiments with the method showed that so-called shifted exponential form of the disutility relevance brought a very successful algorithm for obtaining approximate solution of the problem in a short computational time. In this paper we concentrate on generalization of the approach to the disutility relevance and present results of our research, in which we study an influence of individual parameters on the algorithm effectiveness. In the concluding part of the article, we give a suggestion on construction of resulting algorithm based on the generalized disutility relevance.

Keywords: *weighted p -median problem, disutility relevance, approximate approach*

JEL Classification: C61

AMS Classification: 90C27

1 INTRODUCTION

The design of almost any public service system [3], [6], [14], [15], [18] includes determination of center locations, from which the associated service is distributed to all users of the system. Source of the service must be usually concentrated to a limited number of centers due to economic reasons, regardless of the case whether the service is delivered to users or the users travel for the service to some center. Thus the public service system structure is formed by the deployment of a limited number of service centers and the associated objective in the standard formulation is to minimize some sort of disutility as the social costs, which are proportional to the distances between served objects and the nearest service centers.

A substantial drawback of the original disutility minimization is the linear proportionality of disutility on the distance. This type of dependence may be approved only if cost of transport is considered, but it can be hardly accepted in the case of disutility, which is perceived by a user in emergency as fire, heart attack etc. In such cases, perceived disutility of the service for an afflicted user sharply increases, when the service is delivered after some time-threshold. We suggested the form of disutility, which depends nonlinearly on the distance or time of accessibility. We model this user's utility by nonlinear function, where the threshold represents a parameter of the function.

The above problem can be easily formulated as the weighted p -median problem, what is the task of determination of at most p network nodes as service center locations so that the sum of disutility contributions following from the distance between each user location and the nearest service center is minimal. Nevertheless the p -median problems associated with the above-mentioned service system designs are characterized by considerably big number of possible service center locations. As the location-allocation model constitutes such mathematical programming problem resisting to any attempt at fast solution, when size of the problem exceeds some limit, we make use of so called radial formulation [1], [2], [5], [7]. The radial approach avoids assigning the individual user location to some of located facilities and deals only with information, whether some facility is or is not located in a given radius from the user. This

approach leads to the model similar to the set covering problem, which is easily solvable by a common optimization software tool even for large instances of the problem. The associated solving technique for the modeled service system design problem can be implemented by various disposable tools. Depending on scientific background and information support a designer can choose either the way, when the resulting decision support tool is “tailored” directly to his concrete problem, or the way, when a commercial IP-solver is used. When the first way is followed, the design, development, programming and testing the tool take term of several months. The second way makes use of ready commercial IP-solvers [9]. This way avoids the long time of the tool development and thus the time of an application can be considerably reduced. That is why; we concentrate on the second way in this paper, which includes usage of a commercial IP-solver for the emergency public service system design.

Concentrating on the commercial IP-solver usage, a potential designer must face the complexity of the problem, when an optimal solution is sought. It was found that the number of possible service center locations seriously impacts the computational time in location-allocation models [16]. The necessity of solving larger instances of the design problem leads to the approximate approach, which can enable to solve real-sized problems in admissible time, what was proved for the classical p-median problems by [1], [5], [7], [10]. The suggested approximate approach is adjusted to the generalized disutility model. The approach is based on the upper bound minimization and performs as a heuristic, where the lower bound of the optimal value of the objective function is easy to obtain.

The remainder of the paper is organized as follows. Section 2 introduces the disutility contribution function, which models the contribution of a given service center to perceived disutility of a given user. Section 3 describes the principle of radial formulation employing so-called dividing points. Section 4 describes the ways of dividing point deployment. Section 5 and 6 contain numerical experiments, comparison of the approaches to the dividing point deployment and the final conclusions.

2 MODEL OF PERCEIVED USER’S DISUTILITY

The introduced model of the public service system disutility for an individual user is based on taking into account the minimal disutility contribution from the located service centers. The disutility contribution $d(t)$ for a given service center depends on the time distance t between the user and the service center accordingly to the function described by (1). In the description the symbol t_{krit} represents some time-threshold (limit), where the disutility contribution from the service center considerably increases, if the traveling time from the user to the service center reaches the limit. The positive shaping parameter T makes the increase of the function steeper if it takes a value near to zero. The constant C_0 determines the maximal value of the contribution.

$$d(t) = \frac{C_0}{1 + e^{\frac{-t}{T}}} - \frac{C_0}{1 + e^{\frac{t-t_{krit}}{T}}} \quad (1)$$

If I_1 denotes the set of all located service centers in the public service system and t_{ij} denotes the travelling time from a user located at the place j to the service center location i , then the disutility $Dis_j(I_1)$ of the system for the user j can be modeled by (2).

$$Dis_j(I_1) = \min\{d(t_{ij}) : i \in I_1\} \quad (2)$$

The public service system design problem with the system optimal disutility for users is formulated as the task of service centers determination so that the sum of user disutility contributions is minimal and the total number of located centers does not exceed a given number p . To describe the problems, we denote by J the set of user locations and by I the set of possible center locations. Let b_j denote the number of the users located at j . Then, the problem can be formulated in the following combinatorial form.

$$\min \left\{ \sum_{j \in J} b_j \text{Dis}_j(I_1) : I_1 \subset I, |I_1| \leq p \right\} \quad (3)$$

3 RADIAL MODEL OF THE WEIGTHED P-MEDIAN PROBLEM

To formulate the p-median problem on a discrete network, we denote a set of served users by symbol J and a set of possible service center locations by symbol I . There is necessary to determine at most p locations from I so that the sum of user disutility contributions from each element of J to the nearest center location is minimal. The disutility contribution perceived from a possible center location i by user j is denoted as d_{ij} . The general radial model of the p-median problem can be modeled by further introduced decision variables.

The variable $y_i \in \{0,1\}$ models a decision on service center location at place $i \in I$. The variable takes the value of 1 if a center is located at i and it takes the value of 0 otherwise.

The approximate approach is based on a relaxation of the unique assignment of a service center location to a user. In the radial approach, the disutility value between a user and the nearest service center is approximated unless the center must be assigned. A range of all possible disutility contributions is divided by an increasing sequence of disutility values $0 = D_0, D_1, D_2, \dots, D_v, D_{v+1} = \max\{d_{ij} : i \in I, j \in J\}$ and zero-one constant a_{ij}^s for each triple $[i, j, s]$ for $i \in I, j \in J$ and $s \in \{1, \dots, v\}$ is introduced. The constant a_{ij}^s is equal to 1 if and only if the disutility contribution for the user j and the possible location i is less or equal to D_s , otherwise a_{ij}^s is equal to 0. In addition an auxiliary zero-one variable x_{js} for $s=0, \dots, v$ is introduced. The variable takes the value of 1 if the disutility contribution to the user $j \in J$ from the nearest located center is greater than D_s and this variable takes the value of 0 otherwise.

A zone s of user j corresponds with the interval $(D_s, D_{s+1}]$. A width of the s -th interval is denoted by e_s for $k=0, \dots, v$. Then the expression $e_0 x_{j0} + e_1 x_{j1} + e_2 x_{j2} + e_3 x_{j3} + \dots + e_v x_{jv}$ is an upper approximation of d_{ij} . If the disutility d_{ij} belongs to the interval $(D_s, D_{s+1}]$, then it can be estimated by upper bound D_{s+1} with a possible deviation e_s . Under these prepositions the covering-type model can be formulated as follows:

$$\text{Minimize } \sum_{j \in J} b_j \sum_{s=0}^v e_s x_{js} \quad (4)$$

$$\text{Subject to } x_{js} + \sum_{i \in I} a_{ij}^s y_i \geq 1 \text{ for } j \in J \text{ and } s=0, \dots, v \quad (5)$$

$$\sum_{i \in I} y_i \leq p \quad (6)$$

$$x_{js} \geq 0 \quad j \in J \text{ and } s=0, \dots, v \quad (7)$$

$$y_i \in \{0,1\} \text{ for } i \in I. \quad (8)$$

In the model, the objective function (4) gives the upper bound of the sum of the original disutility contributions perceived by all users. The constraints (5) ensure that the variables x_{jk} are allowed to take the value of 0, if there is at least one center located in radius D_{jk} from the user j . The constraint (6) limits the number of located service centers by p .

The first approach [5] forms the particular finite system of $D_{j0}, D_{j1}, D_{j2}, \dots, D_{jv(j)}, D_{jv(j)+1}$ for each user j by selection from the j -th column of the network distance matrix $\{d_{ij}\}$. The second approach [7] forms one common system of $D_0, D_1, D_2, \dots, D_v, D_{v+1}$ of dividing points, which can be determined in accordance to various rules in a range of network distance values contained in $\{d_{ij}\}$.

4 POSSIBLE DEPLOYMENTS OF DIVIDING POINTS

It is obvious that limited number ν of dividing points D_1, D_2, \dots, D_ν determines size of the model (4)-(8). The model size must be kept below some limit for the problem to be solvable. This restriction impacts an accuracy of the approximate solution. Elements of the disutility contribution matrix $\{d_{ij}\}$ form finite ordered set of values $d^0 < d^1 < \dots < d^m$, where $D_0 = d^0$ and $D_m = d^m$. As the disutility contribution values belong to the interval $[0, C_0]$, one way of dividing point deployment consists in equidistant dividing of this range by dividing points determined accordingly to (9).

$$D_s = d^0 + s \frac{d^m - d^0}{\nu + 1} \quad \text{for } s=1, \dots, \nu \quad (9)$$

Other way of the dividing point deployment is based on so called relevancy of the particular disutility values. The distance relevancy was broadly studied in [10], [11] and [12]. We apply here a similar approach to the disutility contribution relevancy.

Let value d^h have a frequency N_h of its occurrence in the matrix $\{d_{ij}\}$ reduced by the $p-1$ largest disutility values from each column.

A disutility d perceived by user and the nearest located center can be only estimated taking into account that it belongs to an interval $(D_s, D_{s+1}]$ given by a pair of dividing points. Let us denote $D_s^1, D_s^2, \dots, D_s^{\nu(k)}$ the values of the sequence $d^0 < d^1 < \dots < d^m$, which are greater than D_s and less than D_{s+1} . Maximum deviation of the upper estimation D_{s+1} from the exact value d is $D_{s+1} - D_s^1$.

If we were able to anticipate a frequency n_h of each d^h in optimal solution, the total deviation could be minimized by dividing points obtained from solution of the following problem:

$$\text{Minimize} \quad \sum_{t=1}^m \sum_{h=1}^t (d^t - d^h) n_h z_{ht} \quad (10)$$

$$\text{Subject to } z_{h-t} \leq z_{ht} \quad \text{for } t=2, \dots, m \text{ and } h=2, \dots, t \quad (11)$$

$$\sum_{t=h}^m z_{ht} = 1 \quad \text{for } h=1, \dots, m \quad (12)$$

$$\sum_{t=1}^{m-1} z_{tt} = \nu \quad (13)$$

$$z_{ht} \in \{0, 1\} \quad \text{for } t=1, \dots, m \text{ and } h=1, \dots, t \quad (14)$$

If the disutility contribution d^h belongs to the interval which ends at a dividing point d^t , then the decision variable z_{ht} takes the value of 1. Link-up constraints (11) ensure that a value d^h belongs to the interval ending at d^t only if each other value between d^{h-1} and d^t belongs to this interval. Constraints (12) assure that each value d^h belongs to some interval and constraint (13) enables only ν dividing points. After the problem (11)-(14) is solved, the nonzero values of z_{tt} indicate the disutility values, which correspond with dividing points.

The keystone of this approach is determination of appropriate relevancy estimation. Based on the results reported in [13], we decided for the following hypotheses called shifted exponential approach:

$$n_h = N_h g(h) \quad (15)$$

The function $g(h)$ is equal to 1 for each $h \leq h_{crit}$ and it is defined by (16) for $h > h_{crit}$.

$$g(h) = e^{-h+h_{crit}} \quad (16)$$

The constant h_{crit} is a parameter of the approach, which can be determined according to (17).

$$h_{crit} = \min \left\{ h \in Z^+ : \sum_{u=0}^h N_u \geq \frac{\sqrt{|I|/p}}{p} \sum_{t=0}^m N_t \right\} \quad (17)$$

The following section is focused on finding how the way of the dividing point deployment may impact accuracy of the approximate approach to the public service system design, when the nonlinear disutility contribution is considered.

5 NUMERICAL EXPERIMENTS

To compare the both approaches to dividing point deployment, we performed the series of numerical experiments. Each experiment was performed for $t_{krit} = 18$ minutes in the disutility contribution function (1). In the experiments, the shaping parameter T of the disutility contribution $d(t)$ was set to the value of 1 and the coefficient C_0 was set to the value of 100. The number of dividing points was set to the value of 20 in all solved instances both for the equidistant and relevancy dependent deployment.

The instances were derived from real emergency health care system, which was originally designed for each of eight regions of Slovak Republic, i.e. Bratislava (BA), Banská Bystrica (BB), Košice (KE), Nitra (NT), Prešov (PO), Trenčín (TN), Trnava (TT) and Žilina (ZA). This system covers demands of all communities - towns and villages spread over the particular regions by given number of ambulance vehicles, where each of them represents one service center. These community locations were considered as elements of the set J of users' locations and also as elements of the set I of possible service center locations. The time distances t_{ij} were computed from the road network distances for the average speed of 60 kilometer per hour. To obtain bigger set of instances, the original number of ambulances was varied so that we covered given range of ratios $|I|/p$. The reported results were obtained for ratios 2, 10, 20 and 30 and they are plotted into tables 1, 2, 3 and 4 respectively.

To solve the problems described by models (4)-(8) and (10)-(14), the optimization software FICO Xpress 7.5 (64-bit, release 2013) was used and the experiments were run on a PC equipped with the Intel® Core™ i7 2630 QM processor with the parameters: 2.0 GHz and 8 GB RAM.

Each of the following tables is organized so that each row corresponds to one region accordingly to the abbreviation at the beginning of the row. Columns denoted by $|I|$ and p contains cardinality of the set of possible service center locations and maximal number of located centers respectively. Each instance was solved by three solving techniques. The first way consisted of establishing location-allocation model and direct solving by Xpress_IVE. Computational time in seconds and objective function value of obtained optimal solution rounded to integers are denoted as T-ex and F-ex respectively. The second approach made use of the radial formulation employing the equidistant dividing point deployment. Computational time in seconds and objective function value of obtained approximate solution rounded to integers are denoted as T-eq and F-eq respectively.

Table 1: Results obtained for all regions, where the ratio $|I|/p$ was set to 2.

Region	$ I $	p	T-ex	F-ex	T-eq	F-eq	Dif	T-rl	F-rl
BA	87	44	0,34	0	0,02	566	566	0,06	0
BB	515	258	24,31	0	0,13	816	816	0,66	0
KE	460	230	24,07	0	0,22	1083	1083	2,32	0
NT	350	175	8,27	0	0,11	1154	1154	0,61	0
PO	664	332	63,69	0	0,28	1555	1555	1,25	0
TN	276	138	4,82	0	0,08	1245	1245	0,45	0
TT	249	125	3,99	0	0,09	1421	1421	0,61	0
ZA	315	158	7,75	0	0,09	1099	1099	0,56	0

The column denoted by Dif contains the difference between objective function value of the solution obtained by the second approach and objective function value of the optimal solution. The third approach made use of the radial formulation with dividing point deployment based on the estimated relevance. Computational time in seconds and objective function value of obtained approximate solution rounded to integers are denoted as T-rl and F-rl respectively.

Table 2: Results obtained for all regions, where the ratio $|I|/p$ was set to 10.

<i>Region</i>	$ I $	p	T-ex	F-ex	T-eq	F-eq	Dif	T-rl	F-rl
BA	87	9	0,33	95	0,02	566	471	0,25	95
BB	515	52	45,24	73	0,14	826	754	5,24	73
KE	460	46	31,75	24	0,16	917	893	6,47	24
NT	350	35	13,34	78	0,16	1178	1100	3,96	78
PO	664	67	83,49	26	0,30	1394	1368	11,79	26
TN	276	28	7,02	36	0,11	1245	1209	2,37	36
TT	249	25	15,44	75	0,11	1421	1346	5,80	75
ZA	315	32	8,78	132	0,08	1099	968	1,11	132

Table 3: Results obtained for all regions, where the ratio $|I|/p$ was set to 20.

<i>Region</i>	$ I $	p	T-ex	F-ex	T-eq	F-eq	Dif	T-rl	F-rl
BA	87	5	0,33	4600	0,06	4768	168	0,27	4600
BB	515	26	131,93	7489	5,69	7899	410	8,85	7489
KE	460	23	54,96	2389	0,98	3985	1596	6,38	2389
NT	350	18	66,46	4897	2,75	5106	208	18,88	4897
PO	664	34	203,49	2586	2,45	3846	1260	18,89	2586
TN	276	14	5,91	3816	0,09	3932	115	1,00	3816
TT	249	13	9,27	3732	2,59	3796	64	3,71	3732
ZA	315	16	15,59	12570	0,61	12907	337	2,28	12570

Table 4: Results obtained for all regions, where the ratio $|I|/p$ was set to 30.

<i>Region</i>	$ I $	p	T-ex	F-ex	T-eq	F-eq	Dif	T-rl	F-rl
BA	87	3	0,34	30105	0,03	30105	0	0,27	30105
BB	515	18	56,14	30650	0,73	30774	124	4,81	30650
KE	460	16	41,15	19538	1,30	19538	0	8,14	19538
NT	350	12	19,78	30353	1,00	32247	1894	13,53	30353

PO	664	23	93,04	15270	0,61	15395	125	4,10	15270
TN	276	10	4,74	10950	0,16	11076	126	1,36	10950
TT	249	9	6,43	18828	0,19	18828	0	1,31	18828
ZA	315	11	16,66	54396	0,67	57882	3486	2,65	54396

6 CONCLUSIONS

It can be noticed in all presented tables that the approximate approaches are much faster than the exact approach. This characteristic may enable us to obtain a good design of a public service system even in the case, when exact approach fails due to size of the solved instance. Concerning the question about convenient dividing point deployment, it can be stated that the concept of disutility relevance enables to obtain almost optimal solution for each of solved instances, whereas the equidistant dividing point deployment causes the significant deviation from the optimal solution. We suggested an approximate approach to the public service system design, where user's utility is modeled by non-linear function, which increases with increasing time-distance of the user from the nearest located service center. The whole approach is represented by one program in the programming language *Mosel* and the design can be worked up using common commercial IP-solver.

The further research in this area will be aimed at usage of the radial formulation with the purpose to solve larger instances of the public service system design problem with fair criterion design quality and also possibility of applications to the public service system design with more generalized disutility will be studied.

Acknowledgements: This work was supported by the research grants VEGA 1/0296/12 "Public Service Systems with Fair Access to Service", APVV-0760-11 "Designing of Fair Service Systems on Transportation Networks" and also by the following project: University Science Park of the University of Žilina (ITMS: 26220220184) supported by the Research & Development Operational Program funded by the European Regional Development Fund.

References

- [1] Avella, P., Sassano, A. and Vassil'ev, I. (2007) 'Computational study of large scale p-median problems', *Mathematical Programming*, vol.109, pp. 89-114.
- [2] Cornujelos, G., Nemhauser, G.L. and Wolsey, L.A. (1980) 'A canonical representation of simple plant location problems and its applications', *SIAM Journal on Algebraic and Discrete Methods*, vol. 1, no. 3, pp. 261-272.
- [3] Current, J., Daskin, M. and Schilling, D. (2002) 'Discrete network location models', in Drezner, Z. (ed.) *Facility location - Applications and theory*, Berlin: Springer, pp. 81-118.
- [4] Doerner, K., Gutjahr, W., Hartl, R., Karral, Reimann, M. (2005) 'Heuristic solution of an extended double-coverage location problem for Austria', *Central European Journal of Operations Research*, vol. 13, pp. 325-340.
- [5] García, S., Labbé, M., and Marín, A. (2011) 'Solving large p-median problems with a radius formulation', *INFORMS Journal on Computing*, vol. 23, no. 4, pp. 546-556.
- [6] Ingolfsson, A., Budge, S. and Erkut, E. (2008) 'Optimal ambulance location with random delays and travel times', *Health Care management science*, vol. 11, no. 3, pp. 262-274.
- [7] Janáček, J. (2008) 'Approximate Covering Models of Location Problems', *ICAOR '08 – Conference Proceedings*, 1st International Conference on Applied Operational Research, Yerevan, Armenia, pp.53-61.

- [8] Janáček, J. (2013) ‘Modeling of utility in public service system design problem’, *Optimization of region covering by public service systems – Proceedings of the workshop*, Pardubice, Czech Republic, pp. 50-59.
- [9] Janáček, J. (2013) ‘Emergency Public Service System Design Using IP-Solver’, *OTENG’13 – Conference Proceedings*, 1st WSEAS International Conference on Optimization Techniques in Engineering, Antalya, pp. 97-101.
- [10] Janáček, J. and Kvet, M. (2011a) ‘Approximate solving of large p-median problems’, *ORP3-Operational research peripatetic post-graduate programme – Conference Proceedings*, Cádiz, Spain, pp. 221-225.
- [11] Janáček, J. and Kvet, M. (2011b) ‘A sequential zone adjustment method and approximate approach to large p-median problems’, *Operations Research Proceedings 2011: Selected Papers of the International Conference on Operations Research*, Zürich, Switzerland, Berlin Heidelberg: Springer-Verlag, pp. 269-274.
- [12] Janáček, J. and Kvet, M. (2012) ‘Dynamic Zone Adjustment for Approximate Approach to the p-Median Problem’, *ORP3-Operational research peripatetic post-graduate programme – Conference Proceedings*, Linz, Austria, pp. 555-562.
- [13] Janáček, J. and Kvet, M. (2013) ‘Public service system design with disutility relevance estimation’, *Mathematical Methods in Economics 2013 – Conference Proceedings*, The Czech Society for Operations Research Conference, Jihlava, Czech Republic, pp. 332-337.
- [14] Janáček, J., Linda, B. and Ritschelová, I. (2010) ‘Optimization of Municipalities with Extended Competence Selection’, *Prager Economic Papers-Quarterly Journal of Economic Theory and Policy*, vol. 19, no. 1, pp. 21-34.
- [15] Jánošíková, L. (2007) ‘Emergency Medical Service Planning’, *Communications – Scientific Letters of the University of Žilina*, vol. 9, no. 2, pp. 64-68.
- [16] Janáčková, M. and Szendreyová, A. (2006) ‘An impact of set of centers of distribution system design problem on computational time of solving algorithm’, in Mikulski, J. (ed.) *Advances in Transport Systems Telematics*, Katowice, pp 109-112.
- [17] Janáčková, M. and Szendreyová, A. (2013) ‘An Influence of the Lengths Distribution in the Distance Matrix on the Efficiency of the Exact p-Median Algorithm’, *OTENG’13 – Conference Proceedings*, 1st WSEAS International Conference on Optimization Techniques in Engineering, Antalya, pp. 97-101.
- [18] Marianov, V. and Serra, D. (2002) ‘Location problems in the public sector’, in Drezner, Z. (ed.) *Facility location - Applications and theory*, Berlin: Springer, pp. 119-150.

Author’s address

prof. RNDr. Jaroslav Janáček, CSc.

University of Žilina, Faculty of Management Science and Informatics, Department of Transportation Networks

Univerzitná 8215/1, 010 26 Žilina

Slovak Republic

email: Jaroslav.janacek@fri.uniza.sk

Ing. Marek Kvet, PhD.

University of Žilina, University Science Park

Univerzitná 8215/1, 010 26 Žilina

Slovak Republic

email: Marek.Kvet@uniza.sk

ROUNDING THE VALUES IN THE DISTANCE MATRIX AND THE EFFECT ON THE SOLVING THE P-MEDIAN PROBLEM

*Marta Janáčková, Alžbeta Szendreyová,
University of Žilina*

Abstract

A location problem is one part of the public service system design. There are products that can solve the location problem optimally in a short time, even for tasks of wide area networks. The algorithm *BBDual* belongs also to such products. It works effectively on real networks. In practice, the designs of the centers location are usually supplemented by other requirements. These may be different capacity and time constraints, limited numbers of located centers etc. Added conditions require a specific approach to solving the problem. This complicates the solution of the design and increases the computational complexity. Individual methods can be sensitive to the various parameters of the task. This paper deals with the solution of the p -median problem by the algorithm *pBBDual*. We evaluate the impact of the rounding values in the distance matrix on the computing complexity of the algorithm and the impact on the resultant problem solution.

Keywords: *p*-median, distance matrix, network, public systems

JEL Classification: C61

AMS Classification: 90B06, 90B80

1 INTRODUCTION

Inhabitants consider an access to the service as optimal when the service is as close as possible (schools, hospitals, offices). However, there are services for which this property does not apply. Municipal landfills should be placed in a harmony with the environment and far from the dwelling places of the population. It is suitable to place resorts, social care homes and similar institutions to the pleasant environment where there are not disturbed with noise of the settlements and industry. In such cases it is usual to place the possible location out of reach of an existing infrastructure.

In our research, we used data from the road network for solving the tasks of the location problem. Therefore, they do not have to copy exactly the distances in the proposed solution. We are interested in how the rounding of values in the distance matrix affects the computational complexity and what the resultant location of centers is.

We want to place at most p centers to obtain the best values of the objective function. For the purpose of this paper we will solve the p -median problem on the networks, which will be characterized by distance matrices with various rounding of their lengths. As the optimization criterion we consider the sum of distances among customers and their associated service centers.

The formulation of the problem follows: Let I is the set of the possible center locations and let J is the set of the customers. The customers are situated in the nodes (dwelling places) of the network. The number of inhabitants at $j \in J$ is denoted by b_j . We assume that each inhabitant performs the same number of visits at his/her service center. The segment between a possible center location $i \in I$ and a dwelling place $j \in J$ is denoted by coefficient $c_{ij} = b_j d_{ij}$, where d_{ij} is the distance between the center location $i \in I$ and the customer's location $j \in J$. Our task is to place the given number p of service centers to some nodes from the set I . Customers $j \in J$ have to be served from these p nodes so that the sum of traveled kilometers was minimal. The decision on allocation of the customer from node j to the center at the place i is modeled by a variable z_{ij} . It takes the value of 1 if the customer j will be served from the center i and takes the value of 0 otherwise. A variable y_i models the decision on placing or not placing a service center at a

possible center location $i \in I$. The variable y_i takes the value of 1, if the center is located at place $i \in I$ and it takes the value of 0 otherwise. The model has the following form:

$$\text{Minimize } \sum_{i \in I} \sum_{j \in J} c_{ij} z_{ij} \quad (1)$$

$$\text{Subject to } \sum_{i \in I} z_{ij} = 1 \quad \text{for } j \in J \quad (2)$$

$$z_{ij} \leq y_i \quad \text{for } i \in I, j \in J \quad (3)$$

$$\sum_{i \in I} y_i \leq p \quad (4)$$

$$y_i \in \{0,1\} \quad \text{for } i \in I \quad (5)$$

$$z_{ij} \in \{0,1\} \quad \text{for } i \in I, j \in J \quad (6)$$

The coefficients in the model have the following meanings:

I ... the set of possible center locations,

J ... the set of customers (dwelling places),

c_{ij} ... weighted evaluation of the edge between nodes i and j ,

p ... required number of centers.

2 A DEFORMATION OF THE COST MATRIX AND ITS INFLUENCE ON THE P -MEDIAN PROBLEM

To make experiments, we use real data from the road network of the Slovak Republic. We solve the p -median problem on distance matrix without deformation and on distance matrix which values are deformed by rounding.

We suggest the next experiment to test the hypothesis that the deformation of the real network does not significantly affect the properties that influence the computation of the p -median problem. We obtain different sets of task when we round up the distances among the nodes of real network so that they will be divisible by 3, 5, 7 and 10. The purpose of this deformation is to obtain matrices with greater occurrence of the same values. These values will occur in the distance matrix with greater frequency. We will solve the p -median problem by the system XPRESS and algorithm $pBBDual$ for both the original and the deformed data. The requirement for parameter p will be the same in all cases.

We are interested in how the set of the service center locations and the objective value will change after the deformation of the distance matrix. We will compute the objective value as the total availability of service calculated from the real distances among the customers and the locations of the service centers. We will also use the real distances to calculate the objective function of the tasks with deformed data. They will differ because of the different sets of the located centers. We will find out the difference between the accessibility of the service on the real and on the deformed networks. We will use the Hamming distance to compare and evaluate the differences among center locations before and after the deformation of the network. The Hamming distance between two vectors of equal length is the number of coefficients in which they differ. The length of the vector in our task is equal to the number of the candidates for the locations. The vector on the i -th position takes the value of 1, when a service center is located in the i -th node; otherwise it takes the value of 0.

3 EXPERIMENTS

We used the road networks of the regions of the Slovak Republic to perform the testing. These networks consist of 87 up to 664 nodes depending on the region. Both the set of the candidates and the set of the customers consist of all nodes (dwelling places) of the tested region. We also used the whole road network of Slovakia, which contains 2916 nodes. The set of the candidates in this case is formed from 79 district capitals. We solved the p -median problem for each network. The value of p corresponds to one third of the candidates. The time consumption of the solution did not differ neither in the task with deformations nor in the tasks without deformation. Therefore, we do not mention the computational time in our tables.

Table 1 shows the solutions for particular regions of the Slovak Republic. In the columns of the table, there are objective function values of the p -median problem which correspond to the real network without deformation and to the networks with deformations (the distances are rounded up to the values that are divisible by 3, 5, 7 and 10). Parameter m denotes to the number of possible candidates for the location. Parameter p takes the value of one third of the possible candidates.

Table 1 Objective values of the p -median problem

Net	m	p	Without deformation	Coefficient of the deformation			
				3	5	7	10
BA	87	29	4504	4553	4581	4635	4968
BB	515	171	4759	4843	4969	5213	5497
KE	460	153	5675	5776	5997	6402	6876
NR	350	116	6688	6815	6948	7364	7700
PO	664	221	5555	5646	5811	6176	6628
TN	276	92	4113	4247	4362	4590	4878
TT	249	83	5581	5701	5845	6159	6454
ZA	315	105	5594	5745	6021	6292	6569
SR	79	26	877874	877874	877874	882984	885356

The table 2 introduces the differences of the objective values between the real networks without the deformations and the networks with deformations for the same networks.

Table 2 Differences of the objective values (deformed net - real net)

Net	M	p	Coefficient of the deformation			
			3	5	7	10
BA	87	29	49	77	131	464
BB	515	171	84	210	454	738
KE	460	153	101	322	727	1201
NR	350	116	127	260	676	1012
PO	664	221	91	256	621	1073
TN	276	92	134	249	477	765
TT	249	83	120	264	578	873
ZA	315	105	151	427	698	975
SR	79	26	0	0	5110	7482

Because the networks are not in the same size, we calculated the relative differences. Fig. 1 displays the solutions in percent.

We evaluated the Hamming distances from the vectors of the locations between problems

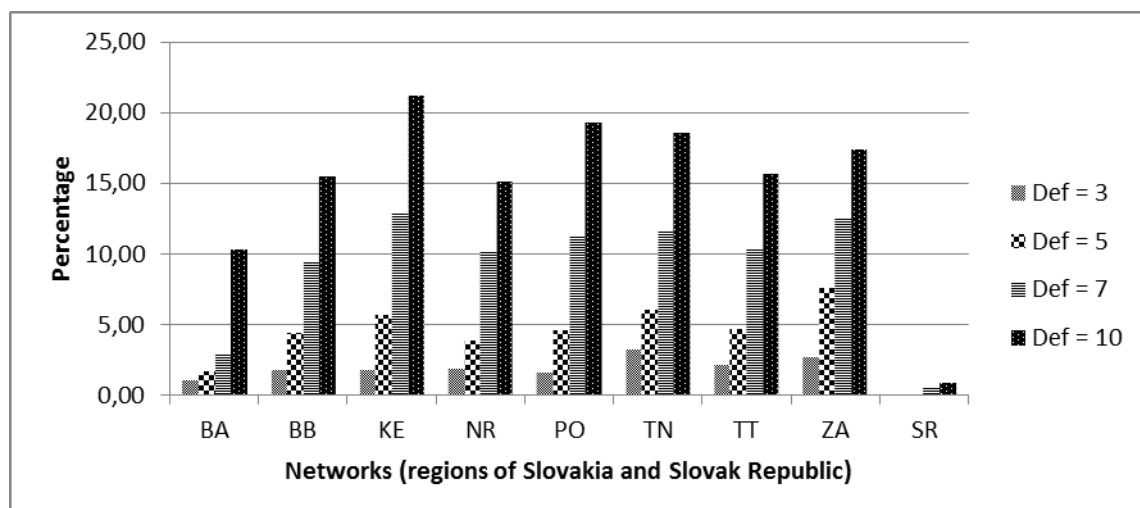

solved on real network and problems solved on networks after the deformation. The relative frequencies of the deviations for the same networks as it was presented in table 1 and Fig. 1 are shown in Fig 2.

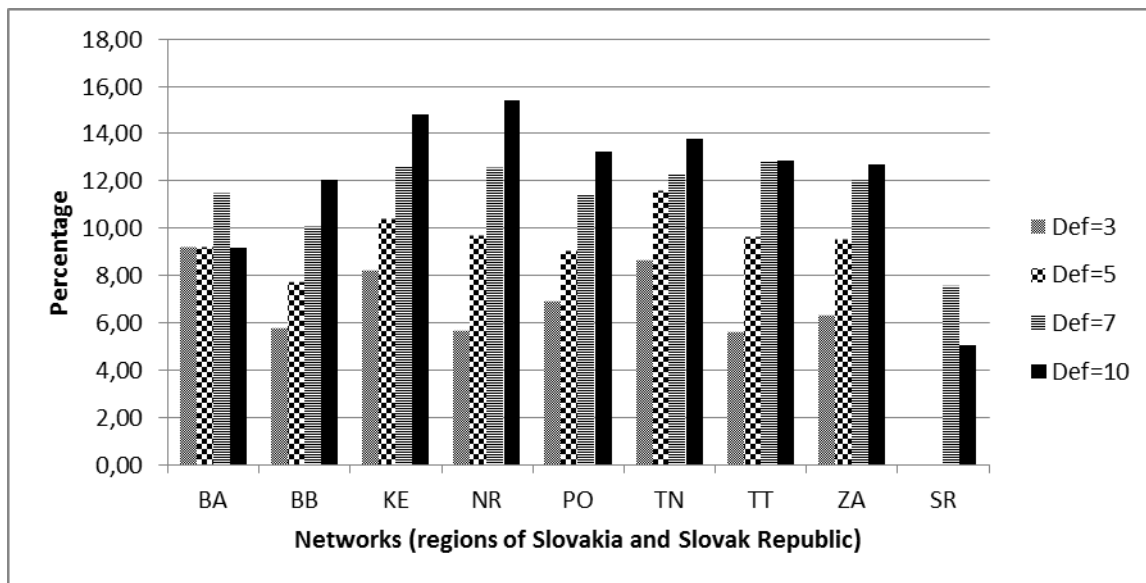

Fig. 2 Hemming distances

4 CONCLUSION

Values in the distance matrix have a range from 1 to 537. A rounding of the distances to the values which are divisible by 3, 5, 7 and 10 is not big given the original length of the distances. The problem that we study in this paper is the influence of the real network deformation on both the computation time and final solution of the task. The results of the task solved on deformed networks are not uniform. The computation time of the tasks with the sets of candidates of numbers from 87 to 664 were not changed after the deformation. The computation times took some milliseconds that are why the differences are negligible.

The real distance matrices contained approximately 500 different values. The number of different values was reduced to less than 180 after the first deformation (the distances were rounded up to the values that are divisible by 3) and it was reduced to circa 50 after the last one (the distances were rounded up to the values that are divisible by 10). The tested matrices contained again a high number of different values after multiplying the distance matrices by the demands of the customers and the deformations of the networks were negated. Nevertheless, differences in the objective values arose in all tested tasks. Differences of the objective functions grew with the growth of the deformation.

The results of our experiment show that even a small deformation of the real network has an impact on the changes of the resultant service centers locations. The differences go up with the enlarging of the number of the candidates.

Acknowledgements: This work was supported by the research grants VEGA 1/0296/12 “Public Service Systems with Fair Access to Service, APVV-0760-11 “Designing of Fair Service Systems on Transportation Networks“ and VEGA 1/0339/13 “Advanced microscopic modelling and complex data sources for designing spatially large public service systems”

References

- [1] Erlenkotter, D. (1978) ‘A Dual-Based Procedure for Uncapacitated Facility Location’, *Operations Research*, vol. 26, no. 6, pp. 992-1009

- [2] Janáčková, M. and Szendreyová, A. (2009) ‘First Aid Stations Location Problem and an Impact of the Set of Candidates on the Recourse of a Patient’, *SOR’09 – Conference Proceedings*, 10th International Symposium on Operational Research in Slovenia, Nova Gorica, pp. 357-361
- [3] Janáčková, M. and Szendreyová, A. (2012) ‘Territory decomposition parameters of distribution tasks’, *Mathematical Methods in Economics 2009 – Conference Proceedings*, The Czech Society for Operations Research Conference, Karviná, pp. 373-378.
- [4] Janáček, J. et al. (2010) *Navrhovanie územne rozľahých obslužných systémov*, Žilina: EDIS - publishers ŽU.
- [5] Um, J. et al. (2009) ‘Scaling laws between population and facility densities’, *Proceedings of the National Academy of Sciences of the USA*, vol. 106, no. 34, pp. 14236-14240.
- [6] *Xpress-MP Manual: Getting Started* (2005) Blisworth: Dash Associates.

Author’s address

RNDr. Marta Janáčková, CSc.

University of Žilina in Žilina, Faculty of Mechanical Engineering, Department of Applied Mathematics

Univerzitná 1, 010 26 Žilina

Slovak Republic

email: marta.janackova@fstroj.uniza.sk

RNDr. Alžbeta Szendreyová, PhD.

University of Žilina in Žilina, Faculty of Operation and Economics of Transport and Communications, Department of Transportation Networks

Univerzitná 1, 010 26 Žilina

Slovak Republic

email: alzbeta.szendreyova@fri.uniza.sk

LOCATION OF EMERGENCY STATIONS AS THE CAPACITATED P-MEDIAN PROBLEM

Eudmila Jánošíková, Michal Žarnay
University of Žilina

Abstract

The access of patients to the emergency medical service depends mainly on the deployment of stations where ambulances stay. In the Slovak Republic, the location of stations is defined by the Ministry of Health for the whole state territory. Our previous research suggested that the service quality can be improved when the station location is proposed by solving the p -median problem, however in this solution there are significant differences in the load of individual ambulances. Therefore, it seems reasonable to limit the population allocated to one station in the problem formulation. This way, the problem of station location becomes a capacitated p -median problem. It can be efficiently solved using a metaheuristic combining local optimisation approach with an IP solver. In the paper, our solution of the capacitated p -median problem is compared with the previously proposed deployment using computer simulation.

Keywords: *capacitated p -median problem, mixed integer programming, local optimization*

JEL Classification: C61

AMS Classification: 90C11, 90C59

1 INTRODUCTION

Emergency medical service (EMS) delivers urgent health care. In the Slovak Republic, the service is provided by ground and air ambulances based at fixed stations. The decisions on the number and placement of ambulances are key factors influencing the system efficiency and that is why they are frequently discussed, evaluated and revised by physicians, healthcare managers and policy makers. The goal of our paper is to point to the abilities of operations research and computer simulation methods to support this decision-making process.

Emergency medical service in the Slovak Republic complies with the Act No 579/2004 Coll. of the National Council of the SR. Regulations of the Ministry of Health of the Slovak Republic No 10548/2009-OL, 11378/2010-OL, and 14016/2010-OL contain details about EMS including EMS stations deployment.

In this paper, we focus on the ground EMS. According to the mentioned regulations, 273 stations are currently deployed in the area of the Slovak Republic. One ambulance and its crew stay at each station. Slovak system works like many other EMS worldwide, where care is mainly given by paramedics, only the most critical cases, like cardiac arrests or respiratory failures are treated by a physician. Ambulances without a physician provide basic life support and their crew consists of a paramedic and a rescuer driver. They are placed in 181 stations. The remaining 92 ambulances are well-equipped advanced life support units. Their teams include a physician, a paramedic and a driver.

The standard urgent care delivery process begins with an emergency call to number 155 or 112. A staff in the operation centre establishes the seriousness of the call, identifies the nearest available ambulance and dispatch this vehicle to the scene. Upon arriving to the patient, the initial treatment is provided. Then, the ambulance typically transports the patient to a hospital, passes him or her to the hospital staff and returns to its base station. If transport is not required, the ambulance returns directly to its base from the scene.

The most critical issue in this process is the response time, i.e. the time elapsed from the moment when an emergency call is received until the ambulance reaches the patient. The prompt arrival

of the rescue saves lives and reduces patient's suffering. The law establishes that the ambulance have to start within 1 minute from receiving a signal from the operation centre. The Slovak legislation does not specify other performance standards, there is only an additional recommendation to deliver medical care in 15 minutes from when a call for rescue arrives. The annual report of the Slovak EMS for year 2012 [9] states that 76.75 % of calls were served within the 15 minutes limit.

It is evident, that the response time is mostly affected by the stations location. In our paper we focus on the question whether a better ambulance location could be reached when a mathematical programming approach is used to solve the location problem. The criteria to compare different locations are:

- average response time,
- percentage of rescue calls with response time within 15 minutes,
- number of calls that had to wait in a queue,
- ambulance workload.

Our previous research suggested that the p -median problem could be a good model for ambulance location, however in this solution there are significant differences in the workload of individual ambulances. Therefore, it seems reasonable to limit the population allocated to one station in the problem formulation. This restriction results in a fair distribution of demand across ambulances. This way the problem of station location becomes a weighted capacitated p -median problem.

2 PROBLEM FORMULATION

In this section, a mathematical programming model for EMS station location will be introduced. The model preserves the current number of stations (273) and looks for a new station location in the area of the Slovak Republic subject to the following assumptions:

1. Because stations are supposed to be deployed in a large-scale area, a macroscopic view must be applied. It means that demands must be aggregated and the whole village or city is considered as one demand zone. As we did not have the detailed statistical data on the EMS operation, we suppose that the number of calls in a municipality is proportional to the number of its inhabitants.
2. The capacity limit of one ambulance is set to 25000 inhabitants according to the analysis of the EMS system [2].
3. Before optimization, one or more stations are placed to municipalities with more than 25000 inhabitants (more precisely, the number of stations is a quotient computed by dividing the number of inhabitants by the capacity limit). The total number of stations (273) is then reduced by the number of these "compulsory" stations (in our concrete case, it is 50) resulting in 223 stations that need to be located using a mathematical programming model.
4. The result of the model should not deviate too much from the current station location since the current location probably respects unwritten or hardly quantified criteria taken into account by an expert when locating stations. Maintaining stations in cities where hospitals are located is considered reasonable.
5. Potential locations (candidates) for stations in the model's network consist of all the nodes with existing EMS stations defined by the official regulations, and of all the other municipalities with at least 300 inhabitants.

The goal in the weighted capacitated p -median problem is to find the location of a fixed number of p stations in order to minimise the average travel time of ambulances to patients. The average travel time is proportional to the total travel time to all demands and can be computed by dividing the total travel time by the number of all demands. Therefore instead of minimising the average travel time one can minimise the total travel time needed to reach all potential patients.

The inputs to the mathematical programming model are as follow:

I	the set of candidate locations
J	the set of municipalities
$H \subset I$	the set of hospital locations
p	the number of stations to be located
t_{ij}	the shortest travel time of an ambulance from node i to node j
b_j	the number of inhabitants of municipality $j \in J$
Q	the capacity limit

The decision on opening a station must be done for each candidate location $i \in I$. This decision can be modelled by the binary variable y_i , which takes the value 1 if a station is located in node i , otherwise it takes the value 0. The assignment of municipality j to the station located in node i is modelled by binary variables x_{ij} . Variable x_{ij} takes value 1, if municipality j will be served by ambulance located in node i , otherwise $x_{ij} = 0$. The model of the weighted p -median problem can be written as:

$$\text{minimise} \quad \sum_{i \in I} \sum_{j \in J} t_{ij} b_j x_{ij} \quad (1)$$

$$\text{subject to} \quad \sum_{i \in I} x_{ij} = 1 \quad \text{for } j \in J \quad (2)$$

$$x_{ij} \leq y_i \quad \text{for } i \in I, j \in J \quad (3)$$

$$\sum_{j \in J} b_j x_{ij} \leq Q \quad \text{for } i \in I \quad (4)$$

$$\sum_{i \in I} y_i = p \quad (5)$$

$$y_i = 1 \quad \text{for } i \in H \quad (6)$$

$$x_{ij}, y_i \in \{0,1\} \quad \text{for } i \in I, j \in J \quad (7)$$

Model description

In the model constraints (1) ensure that every municipality j will be assigned to one station i . Constraints (2) ensure that if a municipality j is assigned to a node i , then a station will be open in the node i . Constraints (4) limit the total number of inhabitants in the region served by one ambulance. Constraint (5) limits the total number of stations that can be sited. Constraints (6) enforce placing stations at those cities that have a hospital. The remaining obligatory constraints (7) specify the definition domains of the variables.

3 SOLUTION METHOD

The capacitated p -median problem is known to be NP-complete. As a consequence, it cannot be solved to optimality even for moderate sized problem instances with hundreds of customers and tens of centres [4]. However the problem instance including all municipalities

in the Slovak Republic is a large-scale instance consisting of 2916 customers ($|J| = 2916$) and 2282 candidate locations ($|I| = 2282$). To make the problem tractable, two techniques were applied:

- the model was reduced by heuristic elimination of variables which are less likely to belong to a good or optimal solution,
- a heuristic method was used for finding a solution.

The elimination of variables concerns variables x and is based on the assumption that patients will not be served by those ambulances that are too far away. That is why not all possible variables x are included in the model but only those variables for which coefficient t_{ij} is less than a predefined threshold. The threshold is defined by the value $\alpha \cdot t^{\max} / \sqrt{p}$ where $t^{\max} = \max\{t_{ij} : i \in I, j \in J\}$ and α is a parameter.

An efficient metaheuristic method based on the decomposition of the problem was proposed by Taillard and published formerly under the name of POPMUSIC [8] and later as local optimization method (LOPT) [7]. In this paper, the later notation is used.

The principle of the method is very simple: if the problem cannot be optimised as a whole, optimise it in parts. The method can be used for every problem that can be divided into subproblems. Then every improvement of the subproblem corresponds to an improvement of the solution of the whole problem. Location problems meet this condition.

First, an initial location of p centres has to be proposed (e.g. by a heuristic). All centres are denoted as temporary and inserted into set C . Then a centre is randomly selected. This selected centre, a few of its closest centres, and the customers allocated to them in the current solution create a subproblem, which is again the location problem but smaller than the initial one. The subproblem is optimised using either exact, heuristic or metaheuristic method. If an improved solution is found, all the centres located in the subproblem remain temporary, otherwise the first centre is removed from C . The process stops when C is empty.

The algorithm of the LOPT method is presented more formally in Fig. 1. An IP solver can be used to solve the subproblem at step 3c. The resulting procedure is then a metaheuristic [6].

- 1) Input: initial position of the p centres, parameter r .
- 2) Set $C = \{1, \dots, p\}$
- 3) While $C \neq \emptyset$, repeat the following steps:
 - 3a) Randomly select a centre $i \in C$.
 - 3b) Let R be the subset of the r closest centres to i ($i \in R$).
 - 3c) Consider the subproblem constructed with the entities allocated to the centres of R and optimize this subproblem with r centres.
 - 3d) If no improved solution has been found at step 3c, set $C = C \setminus \{i\}$, else set $C = C \cup R$.

Figure 1 Local optimization procedure (LOPT) [7]

4 COMPUTATIONAL EXPERIMENTS

The procedure was implemented in the visual development environment Xpress-IVE using solver Xpress-Optimizer v2.2.3 [3]. Parameters r and α were set to values 10 and 1.5, respectively.

The initial location of $p = 223$ stations was computed solving the model (1) – (7) with additional constraints fixing variables y to 1 for those municipalities where stations are today. Since the stations are today in 211 municipalities, 12 stations remain to be located and all municipalities need to be assigned to the exactly one station subject to capacity constraints. The computation time of the solver was limited to 180 seconds and the best solution found in the time frame was taken as the initial solution.

The experiments were performed on a personal computer equipped with the Intel Core i7 processor with 1.60 GHz and 8 GB of RAM. Since even the solution of a subproblem can be time consuming, the computation time of the solver was reduced to 300 seconds per one subproblem. To find the best location, step 3 of the algorithm was repeated 507 times and the total computation time including the initialization step was 12963 seconds. The progress in the objective function value and the number of temporary centres (size of set C) are depicted in Fig. 2 and 3, respectively.

The presented mathematical programming model is based on an implicit assumption that there is always an available ambulance to respond to a call. But in a real system this may not be true, because calls arriving are stochastic events and treatment of a patient is also a random variable. Therefore computer simulation should be used to estimate performance characteristics of the proposed system more realistically. Mostly used performance measures in the emergency

systems are the average system response time, the percentage of calls responded to within a target time limit, and the ambulance utilization.

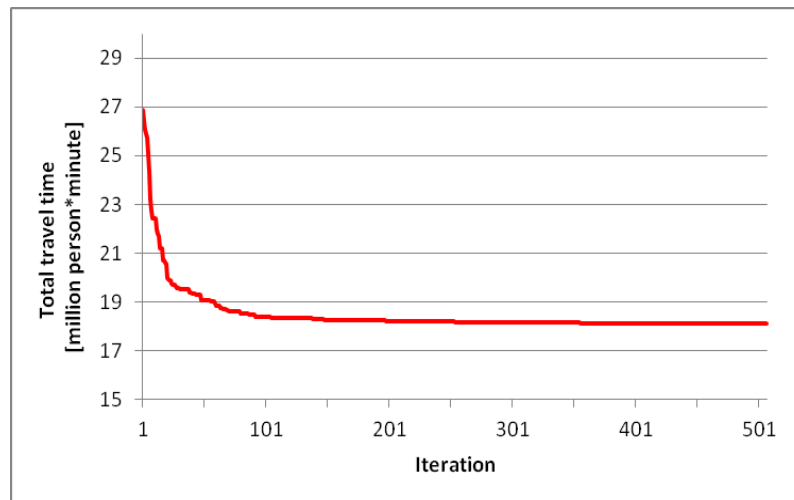

Figure 2 Progress in the objective function value

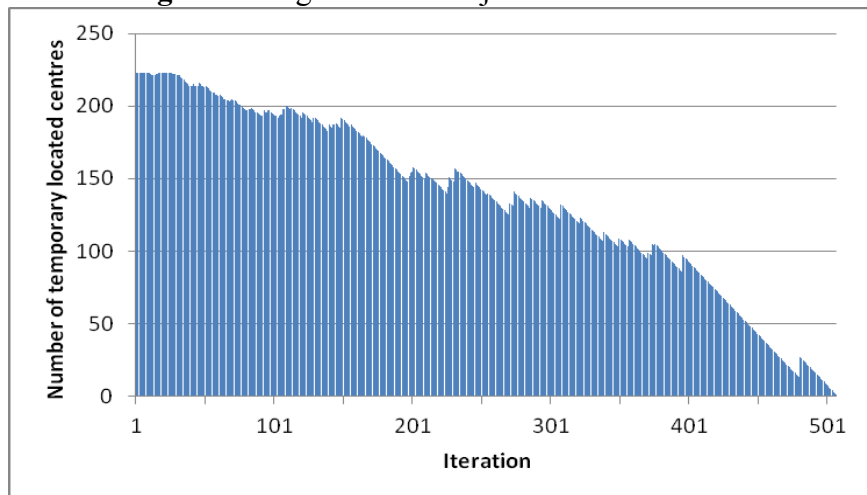

Figure 3 Progress in the number of temporary located centres

The simulation model used for verification of the proposed station location is a macroscopic model that comprises the area of the whole state. As we did not have the relevant statistical data on the EMS operation, we had to take some simplifications. We neglect the call handling by a dispatcher and we assume deterministic travel times (defined by the distance and the average speed for a given road type). The average speed is based on the analysis by Ježek et al. [5]. The city road network is not modeled in detail. Therefore travel times between two sites inside the same city are considered as constant (2 minutes). The patient's treatment time at the scene is exponentially distributed with the mean value of 10 minutes. We suppose that every patient is transported to the nearest hospital, and the time the ambulance spends discharging the patient to the hospital staff is constant (10 minutes). Algorithmic assignment of calls to ambulances may also simplify the reality in some cases: arriving call is assigned to the first available ambulance in the order of the first, second and third nearest to call's site.

The simulation model was implemented in the commercial simulation tool AnyLogic [1]. The results of simulation experiments are summarised in Table 1. Response time does not include the call handling time in the operation centre. A more detailed discussion of simulation experiments will be presented at the conference.

Table 1 Performance characteristics from simulation

	Current location (April 2013)	Capacitated p -median
Average response time [min]	4.13	3.94
% of calls with response time ≤ 15 minutes	99.01	99.00
Average ambulance workload [hours per year]	1090	1075
Standard deviation of ambulance workload [hours per year]	477	392
Average ambulance workload [number of calls per year]	1710	1711
Standard deviation of ambulance workload [number of calls per year]	847	632

5 CONCLUSIONS

In the paper, the problem of EMS ambulance location is formulated as a capacitated p -median problem with additional constraints. A technique reducing the problem size is presented. The results of preliminary simulation experiments indicate that the design proposed by mathematical modelling is better than the current location, with respect to the service quality perceived by patients, as well as the distribution of workload to ambulances.

Acknowledgements: This research was supported by the Scientific Grant Agency of the Ministry of Education of the Slovak Republic and the Slovak Academy of Sciences under project VEGA 1/0296/12 “Public service systems with fair access to service” and by the Slovak Research and Development Agency under project APVV-0760-11 “Designing of Fair Service Systems on Transportation Networks”.

References

- [1] *AnyLogic*, [Online], Available: <http://www.anylogic.com> [13 Sep 2013].
- [2] Bahelka, M. ‘Analýza systému záchranej zdravotnej služby po reforme’, *Health Policy Institute*, [Online], Available: <http://www.hpi.sk/hpi/sk/view/3795/analyza-systemu-zachrannej-zdravotnej-sluzby-po-reforme.html> [3 Mar 2014].
- [3] *FICO™ Xpress Optimization Suite*, [Online], Available: <http://www.fico.com> [10 Oct 2011].
- [4] Gábrišová, L. and Janáček, J. (2013) ‘Návrh rozmiestnenia staníc záchranej služby v Žilinskom kraji’, *Úlohy diskrétní optimalizace v dopravní praxi 2013: optimalizace pokrytí území veřejnými obslužnými systémy – Conference Proceedings*, Pardubice: Univerzita Pardubice, pp. 16-25.
- [5] Ježek, B., Vaněk, J. and Procházka, M. (2011) ‘Estimation of response time for ground ambulance transport’, *Journal of System and Management Science*, vol. 1, no. 5, p. 69-77.
- [6] Stefanello, F., Araújo, O. and Müller, F. (2012) ‘Matheuristics for the capacitated p -median problem’, *Matheuristics'2012 – Workshop Proceedings*, Fourth International Workshop on Model-Based Heuristics, Rio de Janeiro, Brazil, pp. 1-12.
- [7] Taillard, É.D. (2003) ‘Heuristic methods for large centroid clustering problems’, *Journal of Heuristics*, vol. 9, pp. 51-73.
- [8] Taillard, É.D. and Voß, S. (2002) ‘POPMUSIC: Partial Optimization Metaheuristic Under Special Intensification Conditions’, in Ribeiro, C.C. and Hansen, P. (ed.) *Essay and Survey in Metaheuristics*, Kluwer, pp. 613-629.

[9] *Výročná správa Operačného strediska záchranej zdravotnej služby Slovenskej republiky za rok 2012* [Online], Operačné stredisko záchranej zdravotnej služby Slovenskej republiky (2013), Available: <http://www.emergency-slovakia.sk> [13 Sep 2013].

Author's address

doc. Ing. Ludmila Jánošíková, PhD., Ing. Michal Žarnay, PhD.
University of Žilina, Faculty of Management Science and Informatics, Department of
Transportation Networks
Univerzitná 1, 010 26 Žilina
Slovak Republic
e-mail: Ludmila.Janosikova@fri.uniza.sk

ESTIMATION OF INDIRECT COSTS OF UNEMPLOYMENT (CROSS COUNTRY COMPARISON – SR AND CZ)

*Brian König, Tomáš Domonkos,
Institute of Economic Research SAS*

Abstract

The aim of the presented study is to estimate the indirect costs of unemployment in the Slovak Republic and in the Czech Republic. The indirect costs can be assessed by using the principles of Okun's law, which describes the relationship between economic growth and unemployment. Furthermore, by using tax quota (share of public tax income to GDP), the public tax income loss caused by unemployment can be estimated. Moreover, a simple cross country comparison based on the result will be done.

Key words: Okun's law, Indirect Costs of Unemployment, Public Tax Income.

JEL Classification: C44

AMS Classification: 90C15

1. INTRODUCTION

Unemployment represents a phenomenon which unfavorably affects individuals and the society as a whole. The costs of unemployment can be seen in two areas, economic and social, respectively. As a social implication of unemployment higher criminality and loss of working habits can be assumed. Study carried out by Dao, Mai and Loungani, Prakash (2010) found out that the loss of job increases the risk of heart attack and could lead to higher mortality rate. The economic consequences are mostly connected with the loss of government budget's revenues, lower income of individuals and subsequent worsening of their social situation and consumption power. The economic loss caused by additional unemployed person can be split into two main categories: direct and indirect costs of public expenditures. The direct costs are as follows:

- Loss of government revenues caused by reduced collection of direct taxes and social contributions from the employees and the employers respectively.
- Increased public expenditures on unemployment benefits, social security and health insurance addressed to the unemployed.
- Expenditures spent on the administration of unemployed and active labour market policies.

Indirect costs are as follows:

- Are usually expressed by decreasing consumption caused by lower income which may negatively affect production (according to the Okun's Law, which examines the relationship of economic growth and unemployment). Furthermore, the decreasing GDP caused by decreasing consumption leads to decreasing collection of VAT which again causes loss on the side of the public revenues.

The aim of the presented study is to estimate the indirect costs of unemployment in the Slovak Republic (SR) and the Czech Republic (CZ). Furthermore the stability of Okun's law in these countries is tested. This kind of testing is important because both countries are transition economies, and the cost of unemployment could be different during the transition period or later when these countries join the EU or during the period of economic crisis which started from 2009. We assume, that based on the results, it could be possible to choose the most appropriate time period for our analysis. As it was mentioned above, the indirect costs can be assessed by using the principles of Okun's law, which describes the relationship between economic growth and unemployment. Okun's law assumes negative correlation between unemployment and economic growth.

The relation expressed by Okun's law was empirically tested and examined by a number of authors. Moosa (1997) dealt with Okun's law in G7 countries by using different methods for estimating the parameters (OLS, rolling OLS, SUR). The gap version of the relation adopted by various types of filters (the Hodrick-Prescott filter, the Beveridge-Nelson filter, the Kalman filter) for 16 OECD countries was examined by Lee (2000). The stability of Okun's law in US was tested through rolling regression by Knotek (2007). Čadil et al. (2011) assessed the indirect costs of unemployment through relation of Okun's law by using OLS in condition of CZ. A comprehensive summary of papers dealing with Okun's law can be seen in Stock and Vogler-Ludwig (2010).

2. DATA AND METHODOLOGY

The time series used for the purpose of the analysis were quarterly data from 1993Q2 to 2013Q4. Thus, the used sample consists of 83 observations. The time series were seasonally adjusted in Eviews by using Tramo/Seats and expressed as first difference. At the beginning, the rolling regression is adopted to test the stability of Okun's law in case of SR and CZ. The rolling regression estimates a particular relation over several time periods through the ordinary least squares method (OLS). Every single estimation provides a set of parameters and then these are compared among the particular time periods. If the relationship is stable then the parameters should be relatively similar and statistically valid over time. For the purposes of rolling regression, time span of 52 observations was chosen. This number was picked due to, that Okun used the same number of observations when developed this theory. The rolling regression ensures that the distant past values do not influence present data. In order to ensure heteroskedasticity and autocorrelation robust covariances the Newey-West covariance estimator is used. Subsequently, the level of GDP growth will be estimated according to the following formula:

$$\Delta Y_n = b_0 + b_1 \Delta UN_n + e_n \quad (1)$$

Where, ΔY_n denotes one period change in nominal GDP, ΔUN_n represents the change in number of unemployed people, b_0, b_1 are the estimated parameters, wherein the second one represents the respond of ΔY_n to changes of the ΔUN_n . The development of coefficients b_1 in time for both countries is illustrated on the following graph. Horizontal axis represents the end of used time period.

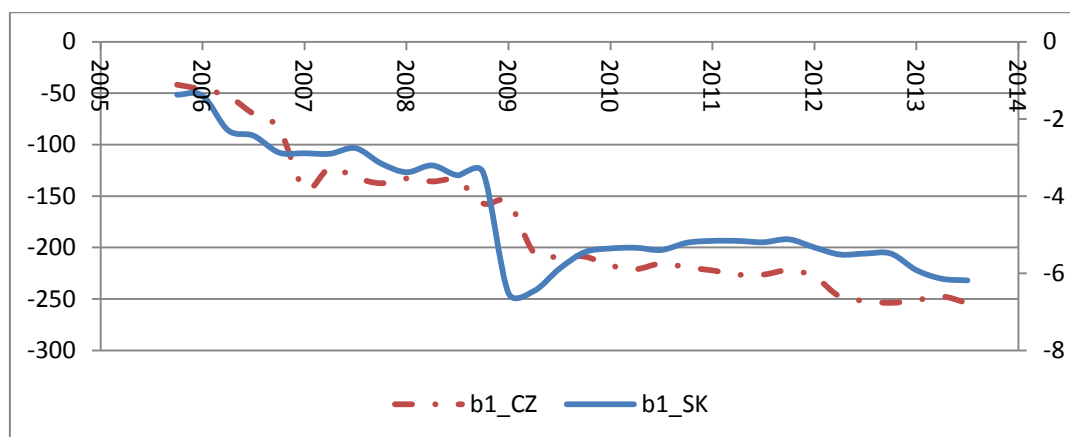

Figure 1 The development of Okun's coefficients estimated through rolling OLS in SR and CZ

The coefficients b_1 for both analyzed countries are negative throughout the whole investigated time period. Even though, the coefficients were changing dramatically over time. In case of SR, at the beginning of the analyzed period the coefficient was -1,4 and has been falling sharply up to the start of economic crisis in 2009 on the level -6,5. Then a slight increase was noticeable by the end of 2011 on the level of -5.1 and after that it has been declining to -6,2 by the end of the time period. In case of CZ, the situation seems to be different.

At the beginning of the analyzed time period, the first b_1 parameter was equal to -41,8 and it has constantly decreasing over time by the end of 2013. The lowest level of the b_1 was -254 in 2013. The large difference between the values of the coefficients in SR and CZ are caused by using different currencies in the econometric equations. It is important to note, that the coefficients in both cases (SR,CZ) are statistically insignificant at the significance level of 5 % when estimated only on data before the year 2008 (Figure 2).

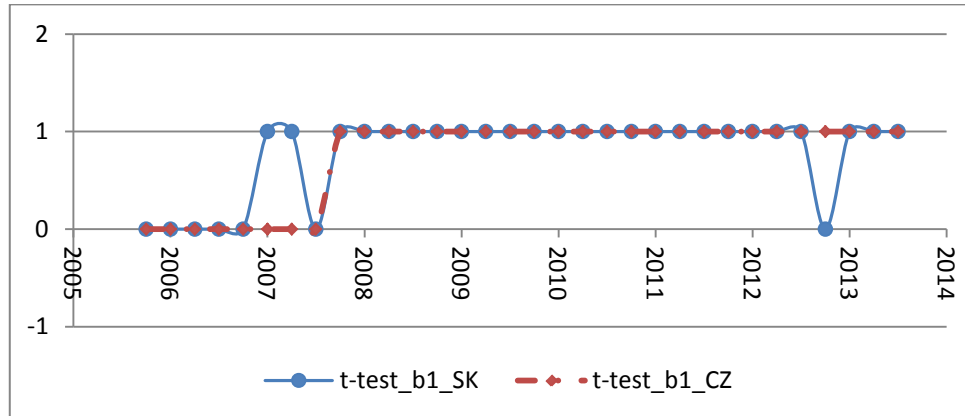

Figure 2 Statistical significance of b_1 tested at the significance level equal to 5 % (1=significant, 0=insignificant)

Based on the results from the rolling regression and the statistical testing of the parameters, the most appropriate time period for the estimation of the indirect costs of unemployment seems to be the time period from 1996q4 to the end of the year 2012q3 in case of SR and in case of CZ the most suitable time period identified is from 1996q3 to 2012q1. The results show that the Okun's Law seems not valid for the period before 1996. For that time period strong economic transition was typical, characterized by economic shocks and structural changes, which may bias the validity of Okun's Law. The time period from 1996 by 2003 was characterized by economic and social transition and political changes. After 1998 SR finally started to experience growth based on healthy and rational economic development. The time period after 2004 was characterized by strong economic growth and increasing employment but in the same time relatively slow decrease of unemployment, caused by increasing number of workforce transiting mostly from schools to the labour market. This may affect the relationship between unemployment and economic growth. The estimation carried out on the selected sample showed significant impact of unemployment on economic growth. The parameters of the estimated equations are as follows:

Table 1 Estimated parameters of the Okun's Law equation, in case of SR in EUR, and in case of CR in CZK.

	b_0	b_1
Parameters in SR	201.5	-5.1
Significance of the parameters: t-stat (p-value)	6.8 (0.000)	-2.7 (0.008)
Parameters in CR	8945.4	-187.1
Significance of the parameters: t-stat (p-value)	6.9 (0.000)	-2.8 (0.006)

Source: Authors' own calculations based on MFSR and ŠÚSR data.

The estimated indirect costs per one unemployed person per month in Slovakia is 1 700 Euros¹. In case of the CZ, the costs of unemployment per one unemployed person is higher 67 167 Czech crowns (2 585 EUR based on the EUR/CZK average exchange rate from the year 2013).

¹ Parameter b_1 for case of SR is expressed in thousands of Euros quarterly and in case of CZ represents indirect costs in thousands of Czech crowns quarterly.

Based on these results, it is possible to estimate the loss of tax revenues caused by decreasing output by using tax quota (tax quota is determined as the percentage of all collected taxes to the GDP of a particular country).

Table 2 Estimated loss of tax caused by one unemployed in EUR

	Tax quota	Estimated loss of revenues from tax SK per month per unemployed person	Tax quota CR	Estimated loss of revenues from tax CR per month per unemployed person
2009	16,29%	276,9 €	18,50%	478,3 €
2010	15,01%	255,2 €	18,30%	473,1 €
2011	15,79%	268,5 €	19,10%	493,8 €
2012	15,35%	261,0 €	19,50%	504,1 €

Source: Authors' own calculations based on MFSR and ŠÚSR data.

The results indicate that the tax revenue loss per unemployed in SR has been fluctuating during the years 2009 - 2012 from 255,2 to 276,9 euro per month. In case of CZ, this value is slightly higher during the same time period, from 473,1 to 504,1 EUR. This difference can be caused by higher GDP per capita and lower rate of unemployment in the CZ compared to SR. Furthermore, the tax quota is higher in the CR compared to SR.

3. CONCLUSIONS

The aim of the presented paper was to identify the most appropriate data sample for estimating the indirect costs per one unemployed person in the Slovak Republic and then in the Czech Republic. For this purpose rolling regression was performed with a time span of 52 observations. The analysis points out that the Okun's law doesn't have significant parameters for the estimations before the year 1996. The most appropriate time period for the estimation of the indirect costs of unemployment seems to be the time period from 1996q4 by the end of the year 2012q3 in case of SR and in case of CZ the most suitable time period identified is from 1996q3 to 2012q1. The estimated relationship between one unemployed and the GDP is in case of Slovakia 1 700 euros and in case of the Czech Republic 2 585 EUR. By using these estimations we were able to measure the tax revenue loss per unemployed. In case of SR it has been fluctuating from 255,2 to 276,9 EUR per month and in case of the CR it has been fluctuating from 473,1 to 504,1 EUR per month. Even the estimated costs are only part of the total costs, the values indicate, that unemployment has significant economic consequences, which should be further investigated.

Acknowledgements: This paper is supported by the Grant Agency of Slovak Republic - VEGA, grant no. 2/0172/12.

This work is supported by the National project of "Centrum sociálneho dialógu" realized by "Centrum vzdelávania MPSVaR SR".

References

- [1] Čadil, J., Pavelka, T., Kaňková, E. and Vorlíček, J. (2011) 'Unemployment Cost Estimate from Public Budgets Perspective', *Politická ekonomie*, no. 5, pp. 618-637.
- [2] Dao, M. and Loungani, P. (2010) 'The Human Cost of Recessions: Assessing It, Reducing It', *IMF Staff Position Note 10/17*, Washington: International Monetary Fund.
- [3] Knotek, E. S. II (2007) 'How Useful is Okun's Law?', *Economic Review*, vol. 2007, Q IV, pp. 73-103.
- [4] Lee, J. (2000) 'The Robustness of Okun's Law: Evidence from OECD Countries', *Journal of Macroeconomics*, vol. 22, no. 2, pp. 331-356.

- [5] Moosa, I. A. (1997) 'A Cross-Country Comparison of Okun's Coefficient', *Journal of Comparative Economics*, vol. 24, no. 3, pp. 335-356.
- [6] Stock, L. and Vogler-Ludwig, K.(2010) 'NAIRU and Okun's Law – The Macro-Economy in a Nutshell? – Final report', *Thematic Paper for the European Commission*, Munich: Directorate General for Employment, Social Affairs and Equal Opportunities.
- [7] Surmanová, K. and Furková, A. (2011) 'Methods for Output Gap Detection', *Mathematical Methods in Economics 2011 – Conference Proceedings (part II)*, The Czech Society for Operations Research Conference, Janská Dolina, Slovakia, pp. 665-670.
- [8] Szomolányi, K., Lukáčik, M. and Lukáčiková, A. (2012) 'The Estimate of Parameters of Production Function of Slovak Economy: Econometric Analysis of Nominal Wages', *Quantitative Methods in Economics: Multiple Criteria Decision Making XVI – Conference Proceedings*, The Slovak Society for Operations Research Conference, Bratislava, pp, 210-215.
- [9] Štefánik, M. (2010) 'Problém prekvalifikovanosti ako indikátor situácie ponuky a dopytu na trhu práce', *Ekonomický časopis*, vol. 58, no. 4, pp. 327-343.

Author's address

Ing. Brian König, PhD.

Institute of Economic Research SAS, Department of Economic Modelling

Šancová 56, 811 05 Bratislava

Slovak Republic

email: brian.konig@savba.sk

Ing. Tomáš Domonkos, PhD.

Institute of Economic Research SAS, Department of Economic Modelling

Šancová 56, 811 05 Bratislava

Slovak Republic

email: tomas.domonkos@savba.sk

MATHEMATICAL MODELS OF THE STUDENT SYNDROME FOR USE IN PROJECT MANAGEMENT

*Petr Kučera, Jan Bartoška, Tomáš Šubrt,
Czech University of Life Sciences in Prague*

Abstract

The paper deals with the “Student Syndrome” phenomenon and its expression using different mathematical models. Every existing activity in any project is, to a higher or lower extent, determined by the effect of the human agent, which commonly takes the Student's syndrome form. The inefficiency of a number of projects in practice is largely caused by an unsuccessful realization of partial activities. The effect of the human agent is in this respect fundamental. The human agent, as an allocated resource in the activity, is liable to a number of non-specified impacts and stimuli, and as such s/he is rather versatile in his/her behaviour. The versatility of the human agent in projects can be described by the “Student Syndrome” phenomenon. If the “Student Syndrome” phenomenon could be completely expressed by means of a mathematical model, it would be possible to improve the prediction of its impact on project activities, and therefore to exploit the resources allocated in the project more efficiently and prevent project crises. We can not expect that the “Student Syndrome” phenomenon can be expressed in a trivial way and using only one mathematical function. This paper proposes several functions for this representation. The proposed functions are compared in terms of their course and the possibility of work schedule resources parameterization. We can regard this original viewpoint as suggestive for the area of human resources management in projects. The article brings the quantification of qualitative features of the human agent in project management.

Keywords. *Project management, Student Syndrome, Parkinson's law, mathematical model, work effort, resource stimulation.*

JEL Classification: C61

AMS Classification: 90B99

Introduction

Using a project time analysis, it is possible to apply the two most well-known methods, i.e. the Critical Path Method and the Critical Chain Method, whose comparison and the way of use is dealt with in Lechler et al. (2005), while Rand (2000) writes about their preferences as well as their critics. Greater attention is given to the Critical Chain Method, which derives from the basic presuppositions of the Theory of Constraints. These presuppositions and starting points are also introduced in Leach (1999), one of them being the phenomenon referred to as the “Student Syndrome” or “procrastination”, which is the topic of this article. The research of procrastination, i.e. meeting deadlines at the last minute, and its elimination in university or higher education courses is dealt with in Tadepalli et al. (2009). The “Student Syndrome” can occur during any human activity, especially when fulfilling tasks during the work on project. In their article, Zika-Viktorsson and Ingelgård (2006) concentrate on the research of psychological aspects in project work environment.

The versatility of the human agent in projects can be described also by the first “Parkinson's law” (Parkinson, 1991). It is natural for people to distribute work effort irregularly to the whole time sequence which was determined by the deadline of the activity termination. The questions of “Parkinson's first law” in project management are further dealt with in e.g. Gutierrez and Kouvelis (1991).

Work effort of an allocated resource has very often been researched in projects from the area of informational technologies and software development, as these projects contain a high level of

indefiniteness, and even common and routine activities are unique. At the same time, it concerns the area where it is possible to find a great number of approaches to estimate how laborious the project will be or how long the activities will take, and also case studies. The proposal for mathematical apparatus for planning the course of activities within a case study is dealt with for instance in Özdamar and Alanya (2001), or Barry et al. (2002). The authors Özdamar and Alanya (2001) propose a particular pseudo-heuristic approach to estimate the activities course where the indefiniteness in the project is expressed by fuzzy sets. Barry et al. (2002) concentrate on the existence and expression of the relation between project duration and total effort and in their theoretical starting points they point out the dynamics of the relation between the effort and project duration when a self-strengthening loop can be expected. The others who research the project complexity and work effort are for instance Clift and Vandenbosh (1999), who point out a connection between the length of life cycle and project management structure where a key factor is again a human agent.

The resource allocation should always proceed from the resource effort which is not constant during activity performance. The work effort will be different for various resources and activities. The aim of the paper is to give a mathematical expression of the human factor impact in the form of the “Student Syndrome” for different types of work contours of activities in projects

1 MATERIALS AND METHODS

1.1 Student Syndrom and Parkinson’s law

Out of his/her natural character, man will always be inclined to relaxation during work effort, and to saving his/her vital energy. Unless a human being is exposed to a certain amount of stress from the loss of profit for a performed activity, s/he is not motivated to suppress this for his/her natural behaviour. For a worker it is convenient to relax provided there is no threat of the loss of his/her future reward. In his book, “The Laws of Professor Parkinson”, Parkinson (1991), in a hilarious way, selected social features having a negative impact are described. In his essays and observations the author especially mentions that “Work increases chronologically with the time that we are able to devote to it”. It can be best demonstrated by the following: The one who has a whole day’s worth of time is also the busiest one.

While assessing a work task, if the deadline of termination is assessed and its resource is a human agent, the resource uses his/her work effort during the realization of the work process irregularly and with a variable intensity. This delay in the realization process which human resources participate in, leads to stress, or to tension on the resource, or to the tension or stress of the resource him/herself. The human agent in the allocated resource evokes the increase in work effort as long as the tension develops and starts to grow. Diagram 1 below demonstrates a possible behaviour of a human resource under the name “Student Syndrome”. The “Student Syndrome” and its progress are dealt with in Cook (1998). The concept is common in both fiction, as well as specialist literature, and it is also introduced in Leach (1999). The concept developed on the basis of the observation of student’s behaviour during their work on given tasks. We can find the equivalent of the phenomenon in psychology under the term procrastination.

1.2 Scheduling the work of resources

Resource conflicts can be resolved by many means – from overtime work allocation, postponing the beginning of work to resource substitution. For our work, we will focus on the method connected with the change in work contour. The contour of resource work for activity is given by at least three influence factors, which are as follows:

- Attitude to succumbing to the Student Syndrome (Bartoška and Šubrt 2011);
- Real need for carried out work depending on the nature of activity with the resource working according to standard work contour, of the type *flat*, *back loaded*, *front loaded*, *early peak*, *late peak*, *double peak*, *bell* and *turtle*;

- Need to adjust one's work speed to key resources of activity because it can be expected that during the realization of various types of activities various resources will have different work effort. By combining these factors we can expect that even complex activities will have a different contour.

The real work contour of the task is the combination of basic contour and inclination to succumb to the Student Syndrome or Parkinson's Law. When solving resource conflicts, in contrast to prevailing experience, we propose the combination of basic contour with real resource effort which includes the impact of the human agent.

1.3 Mathematical model of the "Student Syndrome"

The work effort during the "Student Syndrome" is falling in the first half of the duration and is going up in the second half. Bartoška and Šubrt (2011) propose a mathematical model for the "Student Syndrome" as the multiplication of a growing work trend (exponential function) and the effect of the resource allocation (linear formula with parameter z):

$$p = \left| \sin \left[8\pi (t - 0,5)^3 \right] \left(t + \frac{z-2}{2} \right) e^t \right| \quad (1)$$

where a dependent variable p is the estimate of real resource allocation in %, an independent variable t is the activity duration in %, and z is the estimate of expected maximum resource allocation in % during activity realization.

The model (see Formula 1) enables the modelling of the resource allocation for work effort during an activity. By changing the parameter z in the range $\langle 0;2 \rangle$, we can obtain the estimate of the variability of the resource work effort in time, i.e. (Bartoška and Šubrt 2011):

- Replacing 0% for the parameter z we expect inconsiderable or no resource allocation;
- Replacing 100% for the parameter z we expect an average or relevant resource allocation;
- Replacing 200% for the parameter z we expect extreme allocation or resource over allocation.

2 RESULTS AND DISCUSSION

2.1 Improvement of the mathematical expression of the "Student Syndrome"

First, we propose modification of formula (1) in such a way that it does not contain the absolute value. In this part we will concentrate only on the function of sinus in (1), i.e. the mathematical description of the proper expression of the "Student Syndrome". Let this function be denoted by p_1 . The remaining part of (1) explaining the resource allocation and the growing work trend will be dealt in the following chapters.

The first proposal is the following formula:

$$p_1 = 0.5(1 - \cos(4\pi t + c \sin(2\pi t))) \quad (2)$$

This function has minima $p_1(t) = 0$ in $t = 0$, $t = 0.5$, and $t = 1$. Parameter c enables setting the maxima of resource allocation so that they correspond to usual allocation in reality. For $c = 0$, the maxima are in $t = 0.25$ and $t = 0.75$. In practice, the maxima of resource allocation are closer both to the begin and the end of the activity realization. The parameter c is bigger, the maxima are closer to the activity begin and end.

For some applications, polynomials are more convenient than goniometric functions. The description of the "Student Syndrome" which requires two maxima and one minimum in time interval $t \in (0;1)$ can be realized using the 4th degree polynomial:

$$p_1 = -64t^4 + 128t^3 - 80t^2 + 16t \quad (3)$$

As in case (2), function (3) has minimum $p_1(t) = 0$ in $t = 0.5$ and the value $p_1(t) = 0$ is also achieved in $t = 0$ and $t = 1$. The maxima are approximately in $t = 0.15$ and $t = 0.85$. The function

is normalized so that the maximum value is approximately 1 (the same holds for function (2), too).

The last proposal is a modification of function (2) using a polynomial instead of the sinus inside the cosine:

$$p_1 = 0.5(1 - \cos(4\pi t + c(20t^3 - 30t^2 + 10t))) \quad (4)$$

The function has properties analogous to (2). In particular, parameter c is set to give the maxima for the same t both in (2) and in (4), being itself of the same value in both the cases.

2.2 Mathematical expression of standard work contours

In this chapter, functions expressing the resource allocation, denoted by p_2 according to standard work contours are proposed. The simplest situation is in cases *back loaded* and *front loaded* where linear functions (5) a (6), respectively, suffices:

$$p_2 = t \quad (5)$$

$$p_2 = 1 - t \quad (6)$$

For *double peak*, *bell*, and *turtle*, we propose both goniometric – (7), (8), and (9) – and polynomial – (10), (11), and (12) – expressions, respectively:

$$p_2 = -64t^4 + 128t^3 - 82t^2 + 18t \quad (7)$$

$$p_2 = 16t^4 - 32t^3 + 16t^2 \quad (8)$$

$$p_2 = -4t^2 + 4t \quad (9)$$

$$p_2 = 0.32(1 - \cos(4\pi t)) + 0.5 \sin \pi t \quad (10)$$

$$p_2 = 0.5(1 - \cos(2\pi t)) \quad (11)$$

$$p_2 = \sin \pi t \quad (12)$$

2.3 Mathematical model combining the “Student Syndrome” and standard work contours

The expression of the “Student Syndrome” during the realization of an activity can be variously strong. Therefore, we introduce the rate r of the “Student Syndrome” which acquires values between 0 and 1. The case of $r = 0$ will represent a situation when the “Student Syndrome” does not occur at all and the resource keep the work contour exactly. On the other hand, the case of $r = 1$ means that the “Student Syndrome” manifests in its all strength and the resource absolutely ignore the work contour. Of course, both the previous cases are hypothetical. As a result, we can model the resource work effort p during a real activity realization in the following way:

$$p = rp_1 + (1-r)p_2 \quad (13)$$

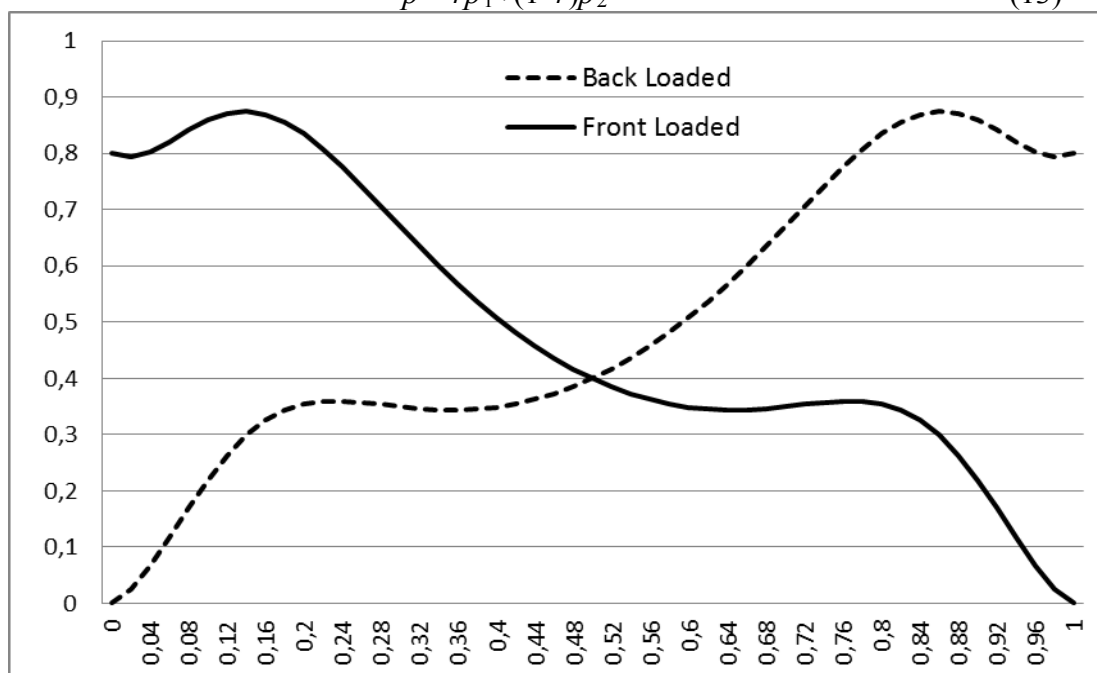

Figure 1 Back Loaded (5) and Front Loaded (6) with Student Syndrome ((15) with $r = 0.2$)

If the human factor impact in the form of the “Student Syndrome” (13) is included into the work contour, the resource work process significantly changes. The impact on project activities may be substantial.

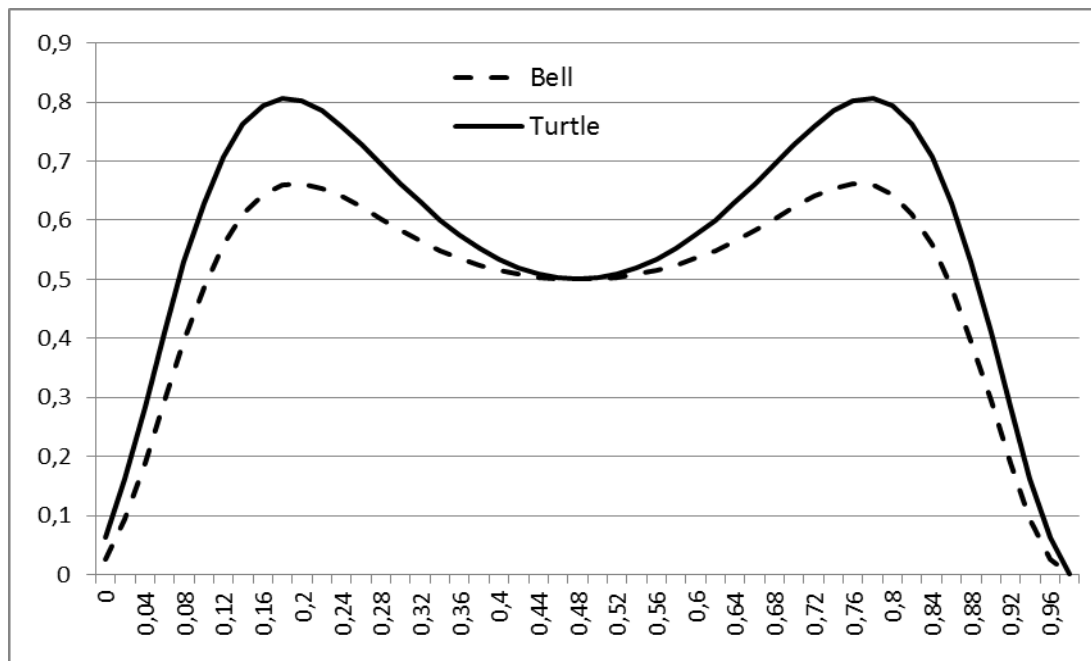

Figure 2 Bell (11) and Turtle (9) with Student Syndrome ((15) with $r = 0.5$)

The mathematical models of work contours with the human resource impact can be implemented in planning the resource work in case of activities of arbitrary project. Thereafter, different runs and shapes of the modified work contours can be composed and thus resource conflicts in projects can be eliminated.

3 CONCLUSION

The paper deals with the human resource impact in the project management. The particular contribution insists in proposals of mathematical models for the “Student Syndrome”. These models are extended by selected resource work contours. Including the “Student Syndrome” impact, the work contour shape significantly changes. The proposal of the “Student Syndrome” impact enclosure into the work contour is based on the weight sum of two functions: the function of the “Student Syndrome” and the function of the work contour; both the functions are proposed here. The expression of the “Student Syndrome”, i.e. the human resource impact, for a particular activity and a particular resource in a project may be important in ordinary practice with the result of project costs savings or avoiding resource conflicts in project planning.

References

- [1] Baccarini, D. (1996) ‘The concept of project complexity – a review’, *International Journal of Project Management*, vol. 4, pp. 201-204.
- [2] Barry, E., Mukhopadhyay, T. and Slaughter, A. S. (2002) ‘Software project duration and effort: An empirical study’, *Information Technology and Management*, vol. 3, pp. 113-136.
- [3] Bartoška, J., Šubrt, T. (2011) ‘The effect of human agent in project management’, *Central European Journal of Operations Research*, vol. 3, p. 369-382.
- [4] Castejón, M., Ordieres, J., Gonzalez, A., Gonzalez, V. (2011) ‘Effort estimates through project complexity’, *Annals of operations research*, vol. 1, pp. 395-406.
- [5] Clift, T., Vandenbosh, M. (1999) ‘Project complexity and efforts to reduce product development cycle time’, *Journal of Business Research*, vol. 45, pp. 187-198.

- [6] Cook, S. C. (1998) 'Applying Critical Chain to Improve the Management of Uncertainty in Projects' [M.B.A. thesis]. Department of Electrical Engineering and Computer Science, Massachusetts Institute of Technology, Massachusetts, USA.
- [7] Hanh, E. D. (2008) 'Mixture densities for project management activity times: A robust approach to PERT', *European Journal of Operational Research*, vol. 2, pp. 450-459.
- [8] König, C. J. and Kleinmann, M. (2005) 'Deadline rush: A time management phenomenon and its mathematical description', *Journal of Psychology: Interdisciplinary and Applied*, vol. 1, pp. 33-45.
- [9] Leach, L. P. (1999) 'Critical Chain Project Management Improves Project Performance', *Project Management Journal*, vol. 30, no. 2, pp. 39-51.
- [10] Lechler, T. G., Ronen, B. and Stohr, E. A. (2005) 'Critical Chain: A New Project Management Paradigm or Old Wine in New Bottles?', *Engineering Management Journal*, vol. 17, no. 4, pp. 45-58.
- [11] Özdamar, L. and Alanya, E. (2001) 'Uncertainty modelling in software development projects (with case study)', *Annals of Operations Research*, vol. 10, pp. 157-178.
- [12] Parkinson, C. N. (1991) 'Parkinson's Law and Other Selected Writings on Management', 1st edition, Singapore: Federal Publications (S) Pte Ltd.
- [13] Premachandra, I. M. (2001) 'An approximation of the activity duration distribution in PERT', *Computers & Operations Research*, vol. 5, pp. 443-452.
- [14] Rand, G. K. (2000) 'Critical chain: the theory of constraints applied to project management', *International Journal of Project Management*, vol. 18, pp. 173-177.
- [15] Gutierrez, G. J. and Kouvelis, P. (1991) 'Parkinson's law and its implications for project management', *Management Science*, vol. 37, no. 8, pp. 990-1001.
- [16] Tadepalli, S., Booth, C. and Pryor, M. (2009) 'Evaluating academic procrastination in a personalized system of instruction based curriculum', *2009 ASEE Annual Conference and Exposition – Conference Proceedings*, Austin, TX.
- [17] Zika-Viktorsson, A. and Ingelgård, A. (2006) 'Reflecting activities in product developing teams: conditions for improved project management processes', *Research in Engineering Design*, vol. 17, pp. 103-111.

Authors' addresses

RNDr. Petr Kučera, Ph.D.

Czech University of Life Sciences in Prague, Faculty of Economics and Management,
Department of Systems Engineering
Kanýcká 29, 165 21 Praha 6 – Suchbátka
Czech Republic

email: kucera@pef.czu.cz

Ing. Jan Bartoška, Ph.D.

Czech University of Life Sciences in Prague, Faculty of Economics and Management,
Department of Systems Engineering
Kanýcká 29, 165 21 Praha 6 – Suchbátka
Czech Republic

email: bartoska@pef.czu.cz

Doc. Ing. Tomáš Šubrt, Ph.D.

Czech University of Life Sciences in Prague, Faculty of Economics and Management,
Department of Systems Engineering
Kanýcká 29, 165 21 Praha 6 – Suchbátka
Czech Republic

email: subrt@pef.czu.cz

MULTI-CRITERIA ANALYSIS AND SIMULATION APPLIED ON THE CZECH ELECTRICITY MARKET

*Martina Kuncová, Jana Sekničková,
University of Economics, Prague*

Abstract

Electricity today belongs to one of the very important commodities. Every year a lot of new machines or devices dependent upon electricity come into existence. That is why the electricity consumption is still raising (although the machines are energy-saving). The electricity market in the Czech Republic started its transformation in 2006. The deregulation caused the increase of the number of suppliers. This situation creates the possibility for the customers to choose the supplier according its needs. Because of the different and non-transparent conditions of the suppliers it is not easy to choose the best one. In this article we compare the offers of the suppliers in different regions via multi-criteria evaluation of alternatives methods and via simulation model to show the procedure for the selection of the best tariff and supplier.

Keywords: *electricity market, suppliers, multi-criteria comparison, simulation*

JEL Classification: C44, C63, O13

AMS Classification: 90C15, 90C29

1 INTRODUCTION

Today's situation on the market can be characterized by the growth of modern technologies and higher and higher usage of the electronic equipment to ease the work, to relax, to study, etc. Although it is said that the new devices are energy-savings ones the increase of its usage and development of new ones causes the increase of electricity consumption. In the Czech Republic we can see this trend especially in the period 2000-2008 and from 2010. The economical crisis in 2008 and 2009 slacken up this growth a little bit. After the Czech Republic energy market deregulation in 2006 a lot of new firms grew up and started to be the energy suppliers. Families are going to adapt to the fact that it is possible to save their money by choosing different supplier. The calculators available on various web pages use only fixed annual energy consumption to assess the best supplier. As it is not possible to set variable consumption we have tried to solve these problems via simulation models [5] and also by multi-criteria comparison [6]. These techniques belong to the mathematical ones that are used to model and analyze electricity markets [9]. In this article we use simulation model and multi-criteria comparison for the prices offered by the best 10 suppliers selected in our previous research [6] for the given household. As the Czech Republic is separated into three areas operated by three distributors we also compare the suppliers and their prices in different regions.

2 CZECH ELECTRICITY MARKET

Description of the electricity market in Czech Republic is not so easy. Electricity can be taken via suppliers and distributors [5], [8]. The number of suppliers is still increasing in the Czech Republic. The complete list of suppliers and their tariffs and prices is not providing an easy survey. It is influenced by the region where we choose the suppliers and also by the electricity take-off amount. Sometimes it is hard to find out the exact price.

The price for the electricity is made by two parts. The first one is the controlled charge for services related to electricity transport from the generator to the final customer. This charge is annually given by Energy Regulatory Office [8]. It covers:

- monthly lease for the circuit breaker
- price per megawatt hour (MWh) in high tariff (HT)
- price per megawatt hour in low tariff (LT)

- price per system services
- price for the support of the renewable energy purchase
- charges for the electricity market operator
- value added tax (with electricity tax 28.30 CZK per 1 MWh)

The second part of the total price is given by the electricity supplier. It covers:

- fixed monthly fee for the selected product
- price per megawatt hour (MWh) in high tariff (HT)
- price per megawatt hour in low tariff (LT)
- electricity ecological tax (34.24 CZK per 1 MWh including VAT)

The Czech Republic is divided into three parts operated by three distributors (Pražská energetická – PRE, E.ON, České energetické závody – ČEZ) so the households cannot choose the distributor but only the supplier [8]. Each household has its tariff rate according to the supplier's conditions. Various tariff rates are offered to households but their selection is limited as there are limitations for the tariff usage. For this article the tariff rate D25 has been chosen as we use a bigger house as an example (it is assigned when the household uses electric water heater). In this case they can use low and high tariff (LT and HT).

3 DATA AND METHODS

According to the previous analysis [6] we use data for 10 suppliers in all three distribution areas (some of them have different prices for district so in this case we selected 3 districts each from one area: Chrudim, Prague, Pelhřimov). Table 1 shows total prices for high and low tariffs and monthly fees (for the circuit breaker from 3x20A to 3x25A) for each supplier for the tariff rate D25 and 3 distribution regions. On the basis of the selected household in [6] the limits for the electricity consumption has been set for each month (the annual consumption is about 10 MWh).

Table 1: Data for suppliers and distribution regions

SUPPLIERS / Prices (CZK/MWh)	distributor E.ON			distributor PRE			distributor ČEZ		
	Price HT	Price LT	Fixed monthly fee (CZK)	Price HT	Price LT	Fixed monthly fee (CZK)	Price HT	Price LT	Fixed monthly fee (CZK)
ČM Energetika	4517,95	1860,24	157,3	4483,61	1852,81	166,98	4687,22	1867,25	175,45
Bohemia Energy	4479,23	1794,9	175,45	4283,25	1739,07	214,17	4500,88	1747,46	199,05
Amper Market	4330,4	1905,79	139,15	4296,06	1898,36	148,83	4499,67	1912,8	157,3
3E - Europe Easy Energy	4493,75	1781,39	136,73	4459,41	1773,96	146,41	4663,02	1788,4	154,88
Comfort Energy	4467,13	1782,8	169,4	4317,84	1759,64	214,17	4499,67	1747,46	199,65
X Energie	4572,4	1840,88	169,4	4349,3	1775,37	214,17	4610,99	1809,17	199,65
Armex Energy	4338,87	1816,68	166,98	4304,53	1809,25	176,66	4508,14	1823,69	185,13
Optimum Trading	4308,62	1925,58	169,4	4274,28	1918,15	179,08	4477,89	1932,59	187,55
E.ON Energie	4481,75	1833,39	166,9	4645,41	1966,96	176,58	4849,02	1981,4	185,05
Nano Energies Trade	4509,48	1894,12	156,09	4475,14	1886,69	165,77	4678,75	1901,13	174,24

3.1 Multi-criteria Evaluation of Alternatives Methods

Multi-criteria evaluation of alternatives belongs to the category of discrete multi-criteria decision making models where all the alternatives (a_1, a_2, \dots, a_p) and criteria (f_1, f_2, \dots, f_k) are known. To solve this kind of model it is necessary to know the preferences of the decision maker. These preferences can be described by aspiration levels (or requirements), criteria order or by the weights of the criteria. We may find a lot of different methods [2], [3], the two that we use are TOPSIS and MAPPACC. We suppose three decision criteria (Price HT, Price LT and Fixed monthly fee) and 10 suppliers as alternatives. As both used methods need cardinal information for criteria for the analyses we use weight vector $\mathbf{v} = (0.225, 0.275, 0.5)$ for high tariff, low tariff and fixed monthly fee (due to consistency with previous analyses [6]).

3.2 Monte Carlo Simulation

Monte Carlo simulation (or technique) is closed to statistics as it is a repeated process of random sampling from the selected probability distributions that represent the real-life processes [1]. On

the basis of the existed information we should select the type of probability distribution that corresponds to our expectations and define all the parameters for. Monte Carlo simulation can help in situations with absence of data as it uses random variables from different distributions. The usage of MS Excel is described in [4].

As we have data about the previous electricity consumption and also according to the expectation of the household owner we have defined the possible minimum and maximum for the consumption for each month [5]. In first simulation experiments the monthly consumption (gc_i) is supposed to be randomly distributed with the uniform distribution (parameters are given by minimum and maximum expected monthly consumption). In the second one the normal distribution with 10 % of the average taken as the standard deviation is used. The formula for the monthly cost calculation for each supplier is following:

$$COST_{ijk} = mf_j + Pht * gc_i * ph_j + Plt * gc_i * pl_j + cb_k \quad (1)$$

where

i ... month, $i = 1, \dots, 12$,

j ... supplier, $j = 1, \dots, 10$,

k ... distributor, $k = 1, 2, 3$,

mf_k ... monthly fee given by the supplier j ,

Pht ... probability of the high tariff usage,

Plt ... probability of the low tariff usage,

gc_i ... generated consumption for the month i ,

ph_j ... price in high tariff for the supplier j ,

pl_j ... price in low tariff for the supplier j ,

cb_k ... monthly fee for the circuit breaker given by the distributor k for its region.

4 RESULTS

It is obvious a tariff (or supplier) that is dominated cannot be chosen and so it is sufficient to analyze only non-dominated variants. In the case of final ranks both dominated and non-dominated alternatives have to be analyzed. Results in table 2 show ranks with respect to TOPSIS and MAPPAC methods for each distributor and also aggregate results for all distributors together. Note that there exist six non-dominated suppliers for E.ON distributor (Amper Market, 3E – Europe Easy Energy, Comfort Energy, Armex Energy, Optimum Trading and E.ON Energie), five non-dominated suppliers for PRE (Bohemia Energy, Amper Market, 3E – Europe Easy Energy, Armex Energy and Optimum Trading) and six non-dominated suppliers for ČEZ (Bohemia Energy, Amper Market, 3E – Europe Easy Energy, Comfort Energy, Armex Energy and Optimum Trading).

Table 2: TOPSIS, MAPPAC and total results

	distributor E.ON			distributor PRE			distributor ČEZ			All distributors	
	TOPSIS		MAPPAC	TOPSIS		MAPPAC	TOPSIS		MAPPAC	Rank	
	coeff.	rank	rank	coeff.	rank	rank	coeff.	rank	rank	average	total
ČM Energetika	0,437	3	5	0,628	3	5	0,524	3	5	4,00	3.-4.
Bohemia Energy	0,280	9	8,5	0,387	8	4	0,354	6	4	6,58	6.
Amper Market	0,734	2	2	0,739	2	2	0,756	2	2	2,00	2.
3E - Europe Easy Energy	0,796	1	1	0,848	1	1	0,859	1	1	1,00	1.
Comfort Energy	0,348	6	4	0,364	9	8	0,351	7	6	6,67	7.
X Energie	0,234	10	10	0,344	10	10	0,278	9	9	9,67	10.
Armex Energy	0,397	5	3	0,609	5	3	0,435	5	3	4,00	3.-4.
Optimum Trading	0,313	7	8,5	0,504	6	7	0,345	8	8	7,42	8.
E.ON Energie	0,308	8	6,5	0,417	7	9	0,272	10	10	8,42	9.
Nano Energies Trade	0,436	4	6,5	0,610	4	6	0,524	4	7	5,25	5.

The best supplier for all distributors is 3E – Europe Easy Energy and the second one is Amper Market, the third and fourth place is divided between dominated ČM Energetika and non-dominated Armex Energy.

We are able also to compare the results from 2014 with the results of previous analysis based on data from year 2013 for ČEZ. This comparison is summarized in table 3. We can see that the list of non-dominated suppliers changed as well as the ranks. These changes are given by changes in prices of suppliers and distributors too. From the results it is obvious that these changes were significant.

The simulation results show that the order for each distribution region is different (table 3, last 3 columns). The order is the same for both simulation cases and it is given by the average total annual costs for the electricity consumption. The minimum annual costs are about 30 thousand CZK. The difference between the best and the worst supplier is about 4 % in E.ON distribution region to 8 % in ČEZ distribution region. In comparison with the prices of the year 2013 (minimum costs about 35 thousand CZK [5]) all suppliers offer lower prices. As for the ranking, Armex can be selected as the cheapest supplier for all regions. The order is not the same as from TOPSIS and MAPPACC but the dominated suppliers have also worst position.

Table 3: Comparison of years 2013 and 2014

	prices of year 2013			prices of year 2014					
	TOPSIS rank	MAPPAC rank	Dominance	TOPSIS rank	MAPPAC rank	Dominance	Distrib. E.ON Simul. rank	Distrib. PRE Simul. rank	Distrib. ČEZ Simul. rank
ČM Energetika	1	1	Non-domin.	3	5	Dominated	8	8	8
Bohemia Energy	2	4	Dominated	6	4	Non-domin.	6	1	1
Amper Market	4	2,5	Non-domin.	2	2	Non-domin.	2	3	4
3E - Europe Easy Energy	5	2,5	Non-domin.	1	1	Non-domin.	3	4	5
Comfort Energy	3	5	Dominated	7	6	Non-domin.	4	5	2
X Energie	6	6	Dominated	9	9	Dominated	10	6	7
Armex Energy	9	7,5	Non-domin.	5	3	Non-domin.	1	2	3
Optimum Trading	8	10	Non-domin.	8	8	Non-domin.	5	7	6
E.ON Energie	7	9	Dominated	10	10	Dominated	7	10	10
Nano Energies Trade	10	7,5	Non-domin.	4	7	Dominated	9	9	9

For non-dominated suppliers we are able (based on formula (1)) calculate the values of energy consumption g_{c_i} that ensure winning of the given supplier. Table 4 summarized the results from this analysis for 45 % energy in high tariff and 55 % in low tariff (the total consumption intervals are in MWh per month).

Table 4: The best suppliers for given energy consumption

Consumption per month		Distributor	The best supplier
from	to		
0	0,46261	all distributors	3E - Europe Easy Energy
0,46261	0,475676	E.ON, PRE	3E - Europe Easy Energy
		ČEZ	Bohemia Energy
0,475676	0,615722	E.ON, PRE	Amper Market
		ČEZ	Bohemia Energy
0,615722	0,77862	E.ON, PRE	Armex Energy
		ČEZ	Bohemia Energy
0,77862	1,101928	E.ON	Armex Energy
		PRE, ČEZ	Bohemia Energy
1,101928	infinity	E.ON	Armex Energy
		PRE	Bohemia Energy
		ČEZ	Comfort Energy

In this table we can see that for model household with energy consumption about 0,83 MWh per month (about 10 MWh per year) the best supplier is Armex Energy in the case of E.ON distributor and Bohemia Energy in the case of PRE and ČEZ. The results also show that non-dominated Optimum Trading is never the winner (in the case we know the total value of energy consumption per month). It is obviously dependent also on ratio of consumption in high tariff to low tariff.

5 CONCLUSION

Selection of the best electricity supplier can be a complicated task. Our analysis has shown that the supplier with the lowest annual cost for one year do not have to be the cheapest one in the next year (for the same consumption). To calculate the annual costs the simulation model can be used, to compare only the prices we can apply the multi-criteria comparison. It is also possible to calculate the ranges for consumption where the non-dominated supplier wins. The results obtained express that dominated offers should not be selected. On the other hand the choice is also influence by the region where the household is as for the same conditions and different regions we have found out different suppliers to be the best ones.

Acknowledgements: This work was supported by grant No. 13-07350S of the Grant Agency of the Czech Republic and also by the grant No. GAČR – P403/12/1387 of the Grant Agency of the Czech Republic.

References

- [1] Banks, J. (1998) *Handbook of Simulation*, USA: John Willey & Sons.
- [2] Fiala, P. (2006) *Modely a metody rozhodování*, Praha: Oeconomica.
- [3] Figueira, J., Greco, S. and Ehrgott M. (2005) *Multiple Criteria Decision Analysis – State of the Art Surveys*, New York: Springer Science + Business Media Inc.
- [4] Kuncová, M. (2006) ‘Practical Application of Monte Carlo Simulation in MS Excel and its Add-ons – The Optimal Mobile Phone Tariffs for Various Types of Consumers in the Czech Republic’, *Mathematical Methods in Economics 2006 – Conference Proceedings*, The Czech Society for Operations Research Conference, Pilsen, Czech Republic, pp. 323-332.
- [5] Kuncová, M. (2013) ‘Monte Carlo Simulation of the Czech Electricity Market’, *Economics and Informatics*, vol. 11, no. 2, in print.
- [6] Kuncová, M. and Rejmanová, V. (2014) ‘Hodnocení dodavatelů elektřiny pomocí matematických metod’, *Hradec Economic Days 2014 – Conference Proceedings*, University of Hradec Králové Conference, Hradec Králové, Czech Republic, pp. 123-129.
- [7] Kuncová, M. and Rejmanová, V. (2013) ‘Volba dodavatele elektřiny pomocí simulačního modelu’, *Nové trendy v ekonometrii a operačním výzkumu – Conference Proceedings*, The Seminar of Department of Econometrics in Prague and Department of Operations Research and Econometrics in Bratislava, Prague, pp. 98-103.
- [8] Energetický regulační úřad (2012) *Roční zpráva o provozu ES ČR za rok 2012*, [Online], Available:
http://www.eru.cz/user_data/files/statistika_elektro/rocní_zprava/2012/RZ_elektro_2012_v1.pdf [15 Nov 2013].
- [9] Ventosa, M., Baíllo, Á., Ramos, A. and Rivier, M. (2005) ‘Electricity Markets modeling trends’, *Energy Policy*, vol.33, no.7, pp.897-913.

Author's address

Ing. Martina Kuncová, Ph.D.

University of Economics, Prague, Faculty of informatics and statistics, Department of Econometrics

W.Churchill sq. 4, 13070 Prague 3, Czech Republic

email: kuncovam@vse.cz

Mgr. Jana Sekničková, Ph.D.

University of Economics, Prague, Faculty of informatics and statistics, Department of Econometrics

W.Churchill sq. 4, 13070 Prague 3, Czech Republic

email: jana.sekniczkova@vse.cz

CLOSED FORM SOLUTION FOR SIMPLE SMALL OPEN ECONOMY

*Patrik Kupkovič, Martin Benkovič,
University of Economics in Bratislava*

Abstract

The purpose of this contribution is to build a canonical dynamic, general equilibrium model of the small open economy and contrast its predictions with some of the empirical regularities of business cycles in small emerging and developed countries. We have also extended basic model with some more realistic features. The model developed in this contribution is simple enough to allow for a full characterization of its equilibrium dynamics using pen and paper. First, we analyze a model without capital for which we found a closed form solution. We find that in this model is trade balance procyclical. Next we analyze a model with capital. We implicitly analyze model dynamics and find that the trade balance experiences initial deterioration only in the case of sufficiently persistent productivity shocks.

Keywords: *Small Open Economy, Business Cycles, Permanent-Income model, closed-form solution, trade balance*

JEL Classification: D58

AMS Classification: 91B51, 91B64

1 FACTS ABOUT BUSINESS CYCLES – CASE OF SLOVAK REPUBLIC

In the theoretical models we study, the basic economic units are the individual consumer, the firm and the government. To compare the predictions of theoretical models to actual data, it is natural to consider time series evidence on per capita measures of aggregate activity. In this contribution we describe the business-cycle properties of output per capita (y_t), total private consumption per capita (c_t), investment per capita (i_t), government consumption per capita (g_t), exports per capita (ex_t), imports per capita (im_t) and our focus will be on the trade balance per capita (tb_t). To compute business-cycle statistics we use annual time series for Slovakia¹. We use time series in real per capita terms and in logs. We must understand fluctuations in business cycle frequency in an open economy. So it is important to extract a cyclical component from time series data. We need some methods to do this. The literature suggests a variety of methods. The most popular are log-linear detrending, log-quadratic detrending, Hodrick-Prescott (HP) filtering, first differencing and band-pass filtering. In our contribution we use log-quadratic filtering². Let y_t denote natural logarithm of real output per capita in time t , y_t^c the cyclical component of y_t , and y_t^{tr} the trend component of y_t . Then we have

$$y_t = y_t^c + y_t^{tr} . \quad (1.1)$$

Using regression we estimated:

$$y_t = \beta_0 + \beta_1 t + \beta_2 t^2 + u_t \quad (1.2)$$

where

$$y_t^c = u_t \quad (1.3)$$

¹ Source: http://epp.eurostat.ec.europa.eu/portal/page/portal/national_accounts/data/database

² This method is used in Uribe and Schmitt-Grohé (2014) textbook, which we follow in this contribution.

and

$$y_t^{tr} = \beta_0 + \beta_1 t + \beta_2 t^2. \quad (1.4)$$

With this log-quadratic method we detrend natural logarithms of all variables. The level of the trade balance are first divided by the secular component of the output and then quadratically detrended. Once we have these detrended series, we can compute business cycle statistics: standard deviations, correlations with output and first order serial correlations. These we find in Table (1.1).

Also we put in this table average business cycle statistics of emerging countries all over the world, following Uribe and Schmitt-Grohé (2014) approach, to compare with our business cycle statistics.

All Slovakia business cycle statistics have common values. Consumption is less volatile than output and investments are more volatile than output. Government spending is nearly as volatile as output. The volatility of exports and imports are almost the same and is two times more volatile than output. Also correlations with output and serial correlations (except investments, imports, export and trade balance) have common values. In this contribution we focus on the small open economy and the key determinant is the trade balance. So we want to build in the next two sections theoretical frameworks to capture the behavior of trade balance, especially negative correlations with output. But the framework will be simple enough to allow us to fully examine the dynamics of the model.

Table 1.1: Business Cycles in Slovakia and Emerging countries

Standard Deviations	Slovakia		Average		Correlations with output	Slovakia		Average		Serial Correlations	Slovakia		Average	
	Slovakia	Average	Slovakia	Average		Slovakia	Average	Slovakia	Average					
σ_y	4,00	8,71	y	1,00	1,00	y	0,68	0,87						
σ_c/σ_y	0,83	0,98	c	0,80	0,75	c	0,66	0,74						
σ_i/σ_y	3,50	2,79	i	0,75	0,77	i	0,35	0,72						
σ_g/σ_y	1,08	2,00	g/y	-0,51	-0,08	g	0,66	0,80						
σ_{im}/σ_y	1,82	2,72	im	0,55	0,50	im	0,23	0,74						
σ_{ex}/σ_y	1,91	2,82	ex	0,38	0,35	ex	0,44	0,74						
$\sigma_{tb/y}$	2,84	3,80	tb/y	-0,19	-0,21	tb/y	0,02	0,52						

Source: Uribe (2014) and own computations.

2 MODEL WITHOUT CAPITAL

In this section we study the standard permanent-income model under uncertainty. See for example Hall (1978) and Romer (2011) and others. We follow Uribe and Schmitt-Grohe (2014) approach.

The economy is populated by a large number of infinitely lived households with utility function

$$E_0 \sum_{t=0}^{\infty} \beta^t U(c_t) \quad (2.1)$$

where c_t denotes consumption and U denotes single period utility function³, and $\beta \in (0,1)$ denotes the subjective discount factor. Each period t households receives an

³ Is assumed to be continuously differentiable, strictly increasing, and strictly concave.

exogenous and stochastic income y_t . Since we examine an open economy households have the ability to borrow or lend in a risk-free internationally traded real bond. This is the main difference between for example Romer (2011) model. The evolution of the debt position of the representative households is given by

$$d_t - d_{t-1} = rd_{t-1} + c_t - y_t \quad (2.2)$$

where d_t denotes the debt position assumed in period t , r denotes the interest rate, assumed to be constant, and y_t is an exogenous and stochastic process for income. It means that a change in the level of debt $d_t - d_{t-1}$ has two sources. Interest services on previously acquired debt, rd_{t-1} , and excess expenditure over income, $c_t - y_t$. Households are assumed to be subject to the no-Ponzi constraint

$$\lim_{j \rightarrow \infty} E_t \frac{d_{t+j}}{(1+r)^j} \leq 0. \quad (2.3)$$

Household want to maximize her utility function (2.1) subject to resource constraint (2.2) and no-Ponzi constraint (2.3). We can use the Lagrangian function now:

$$L_0 = E_0 \sum_{t=0}^{\infty} \beta^t \left\{ U(c_t) + \lambda_t [d_t + y_t - (1+r)d_{t-1} - c_t] \right\} \quad (2.4)$$

where $\beta^t \lambda_t$ denotes the Lagrange multiplier. We take the derivatives of the Lagrangian function with respect to c_t and d_t . Then we set the derivatives equal to zero, which lead us to following optimality conditions:

$$U'(c_t) = \lambda_t \quad (2.5)$$

$$\text{resp. } \beta(1+r)E_t \lambda_{t+1} = \lambda_t. \quad (2.6)$$

Combining these two expressions to eliminate Lagrange multiplier we get the Euler equation:

$$U'(c_t) = \beta(1+r)E_t U'(c_{t+1}). \quad (2.7)$$

At the optimum, the household must be indifferent between allocating a marginal unit of goods to present or future consumption.

2.1 Model analysis

We assume that all households have identical preferences, realizations of stochastic process for income and initial debt position. So, we can interpret c_t and d_t as the aggregate per capita levels of consumption and debt. Equilibrium can be then defined as processes for c_t and d_t satisfying (2.2), (2.3) holding with equality, and (2.7), given initial condition for d_{t-1} and the exogenous process y_t . To analyze equilibrium, we rewrite (2.2) to get intertemporal resource constraint:

$$(1+r)d_{t-1} = E_t \sum_{j=0}^{\infty} \frac{y_{t+j} - c_{t+j}}{(1+r)^j}. \quad (2.8)$$

This equation says that the country's initial net foreign debt position must equal the expected present discounted value of current and future differences between output and consumption. We make two additional assumptions. We require that $\beta(1+r)=1$ and period utility function is quadratic in form: $U(c_t) = -\frac{1}{2}(c_t - \bar{c})^2$. This specification allows us to compute closed-form solution of the model. Using these assumptions we can write Euler equation (2.7) in a simple form

$$c_t = E_t c_{t+1} \quad \text{resp.} \quad c_t = E_t c_{t+j} \quad (2.9)$$

where we use iterated expectations. This says that consumption follows a random walk (see for example Hall (1978)). Stochastic income follows AR (1) process

$$y_t = \rho y_{t-1} + \varepsilon_t \quad (2.10)$$

where ε_t denotes an i.i.d innovation and the parameter $\rho \in (0,1)$ defines the serial correlation of the income process. The larger is ρ , the more persistent is income process. We use this autoregressive structure to rewrite (2.10) and we get:

$$E_t y_{t+j} = \rho^j y_t \quad (2.11)$$

Now we can compute closed-form solution of this model. Plugging (2.9) and (2.11) into (2.8) and solve for c_t , we obtain

$$c_t = \frac{r}{1+r-\rho} y_t - r d_{t-1}. \quad (2.12)$$

Consider the effect of an innovation in the endowment. Because ρ is less than unity, we see that a unit increase in y_t leads to a less than unit increase in consumption. The remaining income is saved for higher future consumption. In our environment, the trade balance is defined as $tb_t = y_t - c_t$.⁴ Using this definition, the equilibrium motion of the trade balance is

$$tb_t = \frac{1-\rho}{1+r-\rho} y_t + r d_{t-1}. \quad (2.13)$$

Let's now investigate dynamics of trade balance. We analyze realistic case when $\rho \in (0,1)$. Assume an unanticipated increase in income. In response to the positive stationary income shock, consumption experiences a "once and for all" increase⁵, but in smaller amplitude than the initial increase in income.⁶ As a result, trade balance improves. After the initial increase trade balance converge to the new long-run level, which is lower than the pre-shock one. It is because in the long-run the economy settles at a lower level of external debt (households have bigger income), whose service requires a smaller trade surplus. We find closed form solutions. However, central failure of the model is the prediction of a procyclical trade balance. So we enrich the model's propagation mechanism.

3 MODEL WITH CAPITAL

In this section we want to show, that allowing for capital accumulation we can deal with procyclical trade balance. Again we have a small open economy populated by a large number of infinitely lived households with preferences described by the utility function

$$E_0 \sum_{t=0}^{\infty} \beta^t U(c_t). \quad (3.1)$$

Households seek to maximize this utility function subject to the following constraints:

$$d_t - d_{t-1} = c_t + i_t - y_t + r d_{t-1}, \quad (3.2)$$

$$y_t = A_t F(k_t), \quad (3.3)$$

$$k_t = k_{t-1} + i_t, \quad (3.4)$$

⁴ Trade balance is defined as the difference between exports and imports of goods and services. In the present model, there is a single good. Therefore, the country either exports or imports this good, on whether the endowment exceeds consumption.

⁵ Because of Euler equation (2.9).

⁶ We see that in (2.12).

⁷ Resource constraint.

⁸ Production function.

⁹ Law of motion of the capital stock.

and the no-Ponzi constraint

$$\lim_{j \rightarrow \infty} E_t \frac{d_{t+j}}{(1+r)^j} \leq 0, \quad (3.5)$$

where k_t denotes the stock of physical capital, and i_t denotes investment in new units of capital, and the production function F satisfies standard conditions¹⁰.

3.1 Model analysis

Again we use a Lagrangian approach to find equilibrium conditions (see section 2.1). But we skip here this process. We have two optimality conditions:

$$r = A_{t+1} F'(k_{t+1}) \text{ and} \quad (3.6)$$

$$c_t = \frac{r}{1+r} \sum_{j=0}^{\infty} \frac{A_{t+j} F(k_{t+j}) - k_{t+j+1} + k_{t+j}}{(1+r)^j} - r d_{t-1}. \quad (3.7)$$

Equilibrium is set of processes for c_t, b_t, k_{t+1} satisfying (3.5)-(3.7), given initial stock of physical capital k_0 , the initial net external debt position d_{t-1} , and the sequence of productivity shocks A_t .

Suppose that in the period 0, unexpectedly, technology factor increase permanently from steady state \bar{A} to $A' > \bar{A}$. Because k_0 was chosen in period -1, we have that $k_0 = \bar{k}$. In the period 0, investment experiences an increase that raises the level of capital available for production in the next period k_1 . We know that productivity is constant after period 0 implies that the capital stock is constant and investment is nil. When we use these findings and put it into (3.7) and evaluate this equation at $t = 0$, we get

$$c' = A' F(\bar{k}) - r \bar{d} > \bar{A} F(\bar{k}) - r \bar{d} = \bar{c}. \quad (3.8)$$

We see that in response to the permanent technology shock, consumption experiences a permanent increase. Which we also find in the model without capital. From (3.8) we can see that, consumption initially increases by more than output. It is due to the fact that output continues to grow after period 0. Finally we derive reaction of the trade balance. Recall that $tb_t = y_t - c_t - i_t$. Change in tb_t in $t = 0$ is $\Delta tb_0 = tb_0 - tb_{t-1} = \Delta y_0 - \Delta c_0 - \Delta i_0$. We have already shown that $\Delta y_0 - \Delta c_0 < 0$ and $\Delta i_0 > 0$. It means that $\Delta tb_0 < 0$. In $t = 1$ $\Delta tb_1 = \Delta y_1 - \Delta c_1 - \Delta i_1$. Between period 0 and period 1 output increases, consumption is unchanged, investment falls and $\Delta tb_1 > 0$. After period 1 trade balance remains constant. When we analyze the case of temporary productivity shocks we find that the trade balance experiences initial improve. And this is against results from the data. Comparing the results obtained under two polar cases, we find that the more persistent are productivity shocks, the more likely is the trade balance to experience an initial deterioration. We can illustrate these findings in Figure 1.

¹⁰ For more details about production function and about estimation of the coefficients see Szomolányi, Lukáčik and Lukáčiková (2012) resp. Szomolányi, Lukáčik and Lukáčiková (2013).

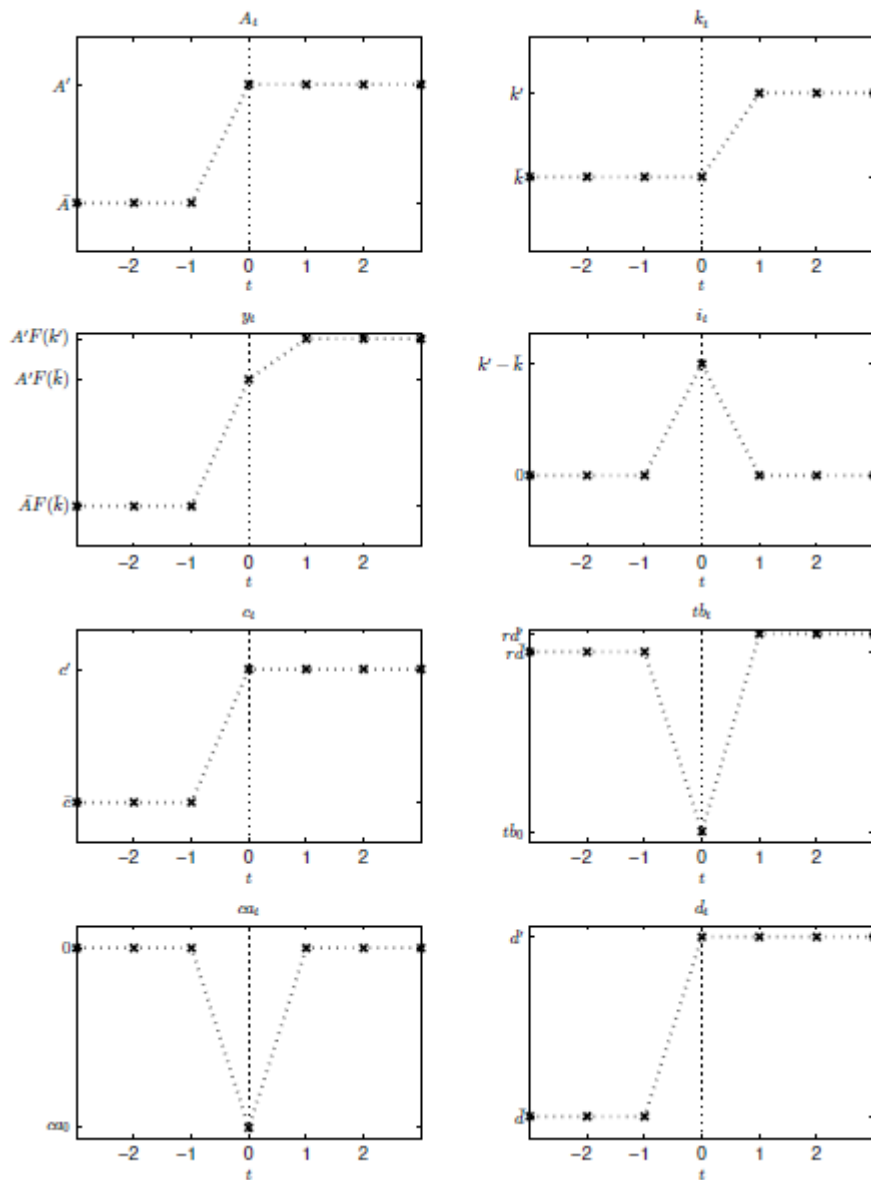

Figure 1 : Adjustment to a Permanent Productivity increase

Source: Uribe and Schmitt-Grohé (2014).

4 CONCLUSION

We analyze two types of model. First, the model without capital allows us for closed form solution. However, trade balance in this type of model was procyclical. Second, we analyze implicitly dynamics of the model with capital. In this model we find that trade balance is countercyclical. In this contribution, we arrived at the conclusion that a model driven by productivity shocks can explain the observed countercyclicality of the trade balance. To do so, productivity shocks must be sufficiently persistent.

References

- [1] Hall, R. E. (1978) ‘Stochastic Implications of the Life Cycle-Permanent Income Hypothesis: Theory and Evidence’, *Journal of Political Economy*, vol. 86, pp. 971-987.
- [2] Romer, D. (2011) *Advanced Macroeconomics*, 4th edition, New York: McGraw-Hill.
- [3] Szomolányi, K., Lukáčik, M. and Lukáčiková, A. (2013) ‘Estimation of the Production Function Parameters in V4 Economies’, *Mathematical Methods in Economics 2013 – Conference Proceedings*, The Czech Society for Operations Research Conference, Jihlava, pp. 898-902.
- [4] Szomolányi, K., Lukáčik, M., and Lukáčiková, A. (2012) ‘The Estimate of Parameters of Production Function of Slovak Economy: Econometric Analysis of Nominal Wages’, *Quantitative Methods in Economics: Multiple Criteria Decision Making XVI – Conference Proceedings*, The Slovak Society for Operations Research Conference, Bratislava, pp. 210-215.
- [5] Uribe, M., Schmitt-Grohé, S. (2014) *Open Economy Macroeconomics*, Lecture notes, [Online], Available: <http://www.columbia.edu/~mu2166/book/oem.pdf> [9 Mar 2014].

Author’s address

Ing. Patrik Kupkovič

University of Economics in Bratislava, Faculty of business informatics, Department of Operations research and Econometrics

Dolnozemska 1/b, 852 35 Bratislava

Slovak Republic

email: patrik.kupkovic@gmail.com

Ing. Martin Benkovič

University of Economics in Bratislava, Faculty of business informatics, Department of Operations research and Econometrics

Dolnozemska 1/b, 852 35 Bratislava

Slovak Republic

email: benkovic.m@gmail.com

IMPACT OF POPULATION DISTRIBUTION ON THE OPTIMAL PUBLIC SERVICE SYSTEM DESIGN

*Marek Kvet, Jaroslav Janáček,
University of Žilina*

Abstract

The public service system design problem is a challenging task for both system designer and operational researcher. As the first one searches for a tool, which enables to obtain service center deployment satisfying future users of the system, the second one faces the necessity to complete the associated tool. This contribution deals with a successful method of the public service system design based on radial formulation of the p -median problem and homogenous system of radii given by so-called dividing points. This method can be easily applied using commercial IP-solver and thus a designer can avoid long term software tool development. Previous implementations of the method made use of the notion of distance relevance to compute an effective deployment of the dividing points. In this contribution we focus on the question, whether the distribution of population can significantly influence the quality of the public service system design.

Keywords: *public service system design, population distribution, weighted p -median problem, radial formulation*

JEL Classification: C61

AMS Classification: 90C06, 90C10, 90C27

1 INTRODUCTION

This paper deals with the problem of designing the optimal structure of most public service systems [2], [4], [12] such that the users' discomfort is minimized. The discomfort is usually evaluated by social costs which are proportional to the sum of demand-weighted network distances between the users and the nearest source of provided service. We assume that all service centers have equal setup cost and enough capacity to serve all users. The service providing facilities must be concentrated to a limited number of centers due to economic and technological reasons [10]. Furthermore, we assume that each user of the designed system is served only from the nearest located service center. Thus mathematical models of the public service system design usually take the form of the weighted p -median problem, where the number of served customers takes the value of several thousands and the number of possible service center locations can take this value as well [1]. The number of possible service center locations seriously impacts the computational time [11]. Concerning the problem size it is obvious that attempts at exact solving using the location-allocation model usually fail due to enormous computational time or memory demands. This weakness has led to the approximate approach based on a radial formulation [3], [5], [6]. Its biggest advantage consists in the possibility of employing common optimization software tools instead of long-term special application development. This approach pays for shorter computational time by a loss of solution accuracy. The accuracy depends on suitable determination of so-called dividing points which are used for distance approximation. The selection of dividing points is based on a new concept following the idea that some network distances from the customers to possible service center locations can be considered relevant, and are expected to belong to the optimal solution. The outlined notion of relevance can be formalized in several ways [8], [9]. In our previous research, only distances between the users and possible service center locations were taken into account when computing the dividing points. Hereby, we are studying the impact of the users' demands

on the effectiveness of suggested covering approach. We would also like to answer the question whether the population distribution can significantly influence the quality of the public service system design.

2 MODELS OF THE PUBLIC SERVICE SYSTEM DESIGN

The weighted p -median problem can be generally formulated as a task of determination of at most p network nodes as facility locations so that the sum of demand-weighted network distances between each user and the nearest located service center is minimal. To formulate a mathematical model of public service system design problem, we denote the set of served customers by J and the set of possible facility locations by I . The network distance between the possible service center location i and the customer location j from J is denoted as d_{ij} . By symbol b_j we denote the demand of the j -th customer. This value may have various interpretations, i. e. number of people demanding the service at the location j . Based on these preliminaries, the weighted p -median problem can be formulated as follows:

$$\text{Minimize} \quad \left\{ \sum_{j \in J} b_j \min \{ d_{ij} : i \in I_1 \} : I_1 \subset I, |I_1| \leq p \right\} \quad (1)$$

The general radial model of the problem discussed in this paper can be formulated by further introduced decision variables. The variable $y_i \in \{0, 1\}$ models the decision about the facility location at the place $i \in I$. The variable takes the value of 1 if the facility is located at i , and it takes the value of 0 otherwise.

The keystone of the approximate approach consists in a relaxation of the assignment of a service center to a customer [3], [6]. To this purpose, the range $\langle 0, \max \{ d_{ij} : i \in I, j \in J \} \rangle$ of all possible values $d_0 < d_1 < \dots < d_m$ of distances from the matrix $\{d_{ij}\}$ used in the former model is partitioned into $r+1$ zones. The zones are separated by a finite ascending sequence of *dividing points* $D_0 \dots D_r, D_m$ where $0 = D_0$ and $D_m = \max \{ d_{ij} : i \in I, j \in J \}$. We introduce a numbering of these zones so that the zone k corresponds to the interval (D_k, D_{k+1}) , the first zone corresponds to (D_1, D_2) and the r -th zone corresponds to the interval (D_r, D_m) . The width of the k -th interval is denoted by e_k for $k = 0 \dots r$. In addition to the variables y_i for $i \in I$ we introduce auxiliary zero-one variables x_{jk} for $j \in J$ and $k = 0 \dots r$. This variable takes the value of 1 if the distance d_{j^*} of the customer j from the nearest located center is greater than D_k and it takes the value of 0 otherwise. Then the expression $e_0 x_{j0} + e_1 x_{j1} + e_2 x_{j2} + e_3 x_{j3} + \dots + e_r x_{jr}$ constitutes an upper approximation of d_{j^*} . It means that if any distance d_{ij} falls to the interval (D_k, D_{k+1}) , it is estimated by the upper bound D_{k+1} .

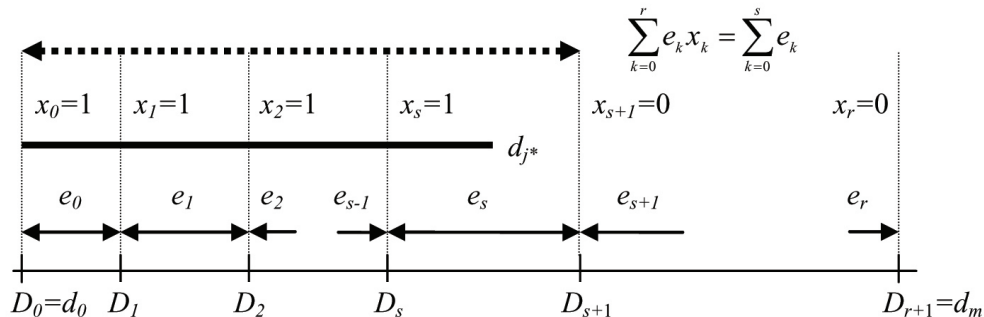

Figure 1: Demonstration of upper approximation of the distance d_{j^*} [7]

Similarly to the generally known set covering model we introduce a zero-one constant a_{ij}^k for each triple $[i, j, k] \in I \times J \times \{0 \dots r\}$. The constant a_{ij}^k is equal to 1 if the distance $d_{ij} \leq D_k$.

Otherwise this constant takes the value of 0. Then the associated covering model connected with the upper distance approximation can be formulated according to [7] as follows:

$$\text{Minimize} \quad \sum_{j \in J} b_j \sum_{k=0}^r e_k x_{jk} \tag{2}$$

$$\text{Subject to:} \quad x_{jk} + \sum_{i \in I} a_{ij}^k y_i \geq 1 \quad \text{for } j \in J \text{ and } k = 0, \dots, r \tag{3}$$

$$\sum_{i \in I} y_i \leq p \tag{4}$$

$$x_{jk} \geq 0 \quad \text{for } j \in J \text{ and } k = 0, \dots, r \tag{5}$$

$$y_i \in \{0,1\} \quad \text{for } i \in I \tag{6}$$

The objective function (2) gives the upper bound of the sum of the original demand-weighted distances. The constraints (3) ensure that the variables x_{jk} are allowed to take the value of 0 if there is at least one center located in radius D_k from the user j . The constraint (4) limits the number of located facilities by p . This approach is reported in more details in [5], [6] and [8].

3 OPTIMAL SELECTION OF DIVIDING POINTS

Optimal dividing points $D_1, D_2 \dots D_r$ are selected in an exact way - by solving the following mathematical model (7) – (11). Basic idea is very simple: The elements of the distance matrix $\{d_{ij}\}$ form a finite ordered set $d_0 < d_1 < \dots < d_m$ where $D_0 = d_0$ and $D_m = d_m$. If there were only r different values between d_0 and d_m , we could determine the dividing points $D_1, D_2 \dots D_r$ so that they would be equal to these values. Then we could obtain the exact solution by solving the covering problem described by the model (2) – (6). Otherwise the distance between a customer and the nearest located service center can be only estimated taking into account that it belongs to the interval (D_k, D_{k+1}) given by a pair of dividing points. If we were able to anticipate the frequency n_h of each d_h in the unknown optimal solution, we could minimize the deviation using dividing points obtained by solving the following model:

$$\text{Minimize} \quad \sum_{t=1}^m \sum_{h=1}^t (d_t - d_h) n_h z_{ht} \tag{7}$$

$$\text{Subject to:} \quad z_{(h-1)t} \leq z_{ht} \quad \text{for } t = 2, \dots, m \text{ and } h = 2, \dots, t \tag{8}$$

$$\sum_{t=h}^m z_{ht} = 1 \quad \text{for } h = 1, 2, \dots, m \tag{9}$$

$$\sum_{t=1}^{m-1} z_{tt} = r \tag{10}$$

$$z_{ht} \geq 0 \quad \text{for } t = 1, \dots, m \text{ and } h = 1, \dots, t \tag{11}$$

The decision variable z_{ht} takes the value of 1 if the distance d_h belongs to the interval which ends by the dividing point d_t . The link-up constraints (8) ensure that the distance d_{h-1} can belong to the interval ending with d_t only if each distance between d_{h-1} and d_t belongs to this interval. Constraint (9) assures that each distance d_h belongs to some interval and constraint (10) enables only r dividing points to be chosen. After the problem (7) – (11) is solved, the nonzero values of z_{tt} indicate the distances d_t which correspond with the optimal dividing points. Then the associated solving technique for public service system design problem consists of the estimation

of the relevancies n_h , solving the dividing points deployment model (7) – (11) and subsequently solving the radial-type weighted covering model (2) – (6).

4 DISTANCE RELEVANCE ESTIMATION

As it was already mentioned in previous section, the optimal dividing points determination is based on the “relevance” of a distance d_h , which expresses a level of our expectation that the value d_h will be a part of the unknown optimal solution, which is searched for. Our previous research was aimed at finding the most suitable form of n_h determination. We have suggested and explored several expressions of relevance and studied their impact on the effectiveness of presented approximate approach with the goal to compare them mainly from the viewpoint of solution accuracy. Particular expressions of distance relevance are discussed in [6], [7] and [8]. Results of performed numerical experiments have indicated that the most suitable form of the distance relevance is the *shifted exponential* form, which can be defined according to [7] as follows: Let the elements of the distance matrix $\{d_{ij}\}$ form a finite ascending sequence of values $d_0 < d_1 < \dots < d_m$ and let N_h be the occurrence frequency of the value d_h in the matrix $\{d_{ij}\}$, where only $|I| - p + 1$ smallest distances of each matrix column are included. This approach to the relevance estimation comes from the exponential form [6], but it takes into account that the slope of the exponential function is too steep in the neighborhood of zero distance and that the relevant distances can be sparsely distributed in this neighborhood. To avoid the groundless reduction of the relevant distance values, we moved the exponential function to the range of biggest distances. Based on these assumptions, the shifted exponential relevance n_h can be estimated according to the formula (12).

$$n_h = N_h g(h) \quad (12)$$

The function $g(h)$ is equal to 1 for each $h \leq h_{crit}$ and it is defined by (13) for $h > h_{crit}$, where T is a positive shaping parameter.

$$g(h) = e^{-\frac{h-h_{crit}}{T}} \quad (13)$$

The most suitable setting of T proved to be the value of 1 as it is shown in [7]. The constant h_{crit} is also a parameter of the approach. It represents a critical value, which can be determined according to (14) for some given value of another parameter q .

$$h_{crit} = \min \left\{ h \in Z^+ : \sum_{u=0}^h N_u \geq \frac{q}{P} \sum_{t=0}^m N_t \right\} \quad (14)$$

It is important to note that the ratio of q to p cannot exceed the value of 1. Otherwise the value of h_{crit} is not computable in a correct way – it cannot exceed its possible range $0 \dots m$. Our previous research described in [7] was aimed at a proper setting of the parameter q . The results confirmed there is relation between the size of solved problem and the most suitable value of q . Based on the results we suggested the formula (15).

$$q = \sqrt{\frac{|I|}{p}} \quad (15)$$

In some small instances it may happen that the ratio of q to p exceeds the value of 1, that's why we decided to define a limit for that ratio so that its maximal value can be 0.9.

Based on these preliminaries we realized a sequence of numerical experiments to find out the impact of population distribution to the effectiveness of suggested approximate covering approach, which is measured by saved computational time in comparison to the location-allocation approach and the solution accuracy as well.

5 COMPUTATIONAL STUDY

We have introduced the approximate method for public service system design problem with the shifted exponential estimation of the distance relevance. This method depends on the pair of parameters T and r . The parameter T was set to the value of 1 and all tested instances were solved for $r = 20$ dividing points. The parameters h_{crit} and q were determined according to the expressions (14) and (15) respectively. Hereby, we are presenting the results of numerical experiments, which were aimed at the impact of users' demands b_j to the effectiveness of suggested covering method. The effectiveness is studied from the viewpoint of computational time and the solution accuracy. The accuracy of the solution is measured by so-called *gap*, which is defined as follows: Let ES denote the objective function value of the **Exact Solution** of the problem obtained by solving the location-allocation model and let CS be the real objective function value of the **Covering Solution** computed according to (16). Since the covering approach provides only the upper approximation of distances, the values of decision variables y_i for $i \in I$ have to input the formula (16) to achieve the resulting objective function value. Based on mentioned facts, it is obvious that the most important output of the covering method is not the objective function value, but the vector Y of location variables y_i for $i \in I$.

$$CS = \sum_{j \in J} b_j \min \{d_{ij} : i \in I, y_i = 1\} \quad (16)$$

The mentioned *gap* is defined as the difference between ES and CS expressed in percentage of the exact solution ES as it is formalized by (17).

$$gap = \frac{|ES - CS|}{ES} * 100 \quad (17)$$

All experiments were performed using the optimization software FICO Xpress 7.5 (64-bit, release 2013) for both location-allocation model and the covering approach. The associated code was run on a PC equipped with the Intel® Core™ i7 2630QM processor with the parameters: 2.0 GHz and 8 GB RAM.

Particular approaches to the population distribution impact exploration were tested on the pool of benchmarks obtained from the road network of Slovak Republic. The instances are organized so that they correspond to the administrative organization of Slovakia. For each self-governing region (Bratislava, Banská Bystrica, Košice, Nitra, Prešov, Trenčín, Trnava and Žilina) all cities and villages with corresponding number of inhabitants b_j were taken. The number of possible service center locations $|I|$ is the same as the number of user locations $|J|$ in all solved instances. It means that each community (even the smallest) may represent a possible service center location. The size of the set I for each self-governing region is shown in the following table.

Table 1: Size of tested benchmarks

Self-governing region	Number of possible service center locations
Bratislava	87
Banská Bystrica	515
Košice	460
Nitra	350
Prešov	664
Trenčín	276
Trnava	249
Žilina	315

For each size of the set I , 11 different instances were solved. These instances differ in the value of parameter p , which limits the number of located service centers. The value of p was set in such a way, that the ratio of $|I|$ to p equals 2, 3, 4, 5, 10, 15, 20, 30, 40, 50 and 60 respectively. The reported results are the average values of all 8 regions grouped by $|I|/p$.

The first set of numerical experiments was performed with the goal to verify the hypothesis, whether the customers' demands b_j play some role in the approximate covering approach. The experiments were organized such that the objective function of the covering model (2) – (6) took the form of (18). It means that the coefficients b_j for $j \in J$ were not taken into account. In other words, all values of b_j were set to the value of 1.

$$\text{Minimize} \quad \sum_{j \in J} \sum_{k=0}^r e_k x_{jk} \quad (18)$$

The resulting values of decision variables y_i for $i \in I$ were used in the formula (16) to obtain the real corresponding objective function value, not only distance approximation. Based on this value, the *gap* was computed according to the expression (17). The results of experiments are shown in Table 2, which contains not only time comparison of exact location-allocation approach and the covering one, but also the evaluation of the covering solution accuracy. Here, it is important to note, that the computational time of the covering method contains two optimization processes. At first, optimal dividing points are computed by solving the model (7) – (11) and based on the dividing points set the covering model (2) – (6) is computed. The following table shows the results for the case, when we optimized only the network distances and studied the consequences to the public service system design described by (1).

Table 2: Results of basic numerical experiments grouped by the ratio of $|I|$ to p

$ I /p$	Exact approach Time [s]	Covering approach without b_j	
		Time [s]	Gap [%]
2	15.81	0.81	264,20
3	15.91	1.10	214,51
4	16.11	1.37	156,80
5	16.63	1.68	139,05
10	20.45	1.90	80,26
15	17.97	2.33	53,75
20	23.34	3.91	43,68
30	20.20	7.18	35,61
40	20.90	5.81	23,57
50	22.11	7.87	26,94
60	30.99	9.45	18,32
Average	20.04	3.94	96,06

The obtained results are interesting from different points of view. The first advantage of presented approximate covering approach consists in the average computational time, which is much smaller in comparison to the exact location-allocation approach. It is generally known, that the set covering problem is well solvable even in cases of large instances. From this point of view suggested covering approach presents a very useful solving technique for the optimal public service system design.

When analyzing the solution accuracy, we can see that obtained results are quite bad. The difference between the covering solution and the exact one is extremely high. On the other hand, such bad results could be expected, because the covering model minimized only the upper distance approximations and the weights b_j were not taken into consideration. Thus we can

conclude that the customers’ demands play a very important role and these coefficients should not be ignored in the process of public service system modelling. That’s why we aimed our research at the options, how to integrate the values b_j into the covering approach.

The first way is very simple – just to return to the objective function (2) in the covering model (2) – (6) and apply the coefficients b_j . The dividing points can be still computed according to the formula (12). It is natural to expect that applying the users’ demands b_j in the objective function (2) will bring significantly more precise results in a short time. This hypothesis was confirmed by the numerical experiments presented later.

Another suggested approach follows the idea that the relevance n_h of individual distance d_h may be proportional not only to its occurrence frequency N_h in the matrix $\{d_{ij}\}$, but it can also depend on the population distribution, mainly on the sum of user demands connected with d_h . Let us define a new constant B_h for each d_h as follows:

$$B_h = \sum_{i \in I} \sum_{\substack{j \in J \\ d_{ij} = d_h}} b_j \tag{19}$$

The relevance n_h of each d_h is now computed as a combination of two different criteria. The first of them takes into account former introduced frequency N_h and the second one is given by the value B_h . The values of B_h are usually in order higher than N_h and therefore it is necessary to normalize both criteria according to the expressions (20) and (21).

$$\overline{B}_h = \frac{B_h}{\sum_{u=0}^m B_u} \tag{20}$$

$$\overline{N}_h = \frac{N_h}{\sum_{u=0}^m N_u} \tag{21}$$

The relevance n_h is then computed in accordance to the formula (22), where α is a parameter weighting particular criteria by its value from the interval $\langle 0, 1 \rangle$. If $\alpha = 0$, then the demands b_j are not taken into account as in (12). In such case normalization of N_h does not play any role.

$$n_h = (\overline{B}_h)^\alpha (\overline{N}_h)^{1-\alpha} g(h) \tag{22}$$

This advanced definition of distance relevance was tested for different values of α to find out, whether this quite complicated formulation of n_h brings some improvement of the solution accuracy or not. Average results (computational time comparison and *gap* evaluation) are reported in the following Tables 3 and 4.

Table 3: Time comparison of different covering approaches, average computational time is given in seconds

I / p	Exact approach	Covering approach				
		Relevance (12)	Relevance (22)			
			$\alpha = 0.2$	$\alpha = 0.4$	$\alpha = 0.6$	$\alpha = 0.8$
2	15.81	0.66	0.63	0.63	0.59	0.56
3	15.91	0.87	0.81	0.78	0.80	0.78
4	16.11	0.90	0.82	0.85	0.90	0.94
5	16.63	1.01	0.96	1.03	1.02	0.90
10	20.45	1.22	1.46	1.38	1.33	1.26
15	17.97	1.72	1.80	1.61	1.75	1.87
20	23.34	2.30	2.38	2.49	2.44	2.36

30	20.20	3.22	3.28	3.13	3.25	3.41
40	20.90	3.80	3.84	3.80	3.51	3.61
50	22.11	4.10	4.25	4.02	4.18	4.03
60	30.99	4.96	4.93	5.47	4.96	5.01
Average	20.04	2.25	2.29	2.29	2.25	2.25

Table 4: Evaluation of solution accuracy for different covering approaches, gap is computed according to (17)

$ I /p$	Covering approach				
	Relevance (12)	Relevance (22)			
		$\alpha = 0.2$	$\alpha = 0.4$	$\alpha = 0.6$	$\alpha = 0.8$
2	0.00	0.00	0.00	0.00	0.00
3	0.00	0.00	0.00	0.00	0.00
4	0.00	0.00	0.00	0.00	0.00
5	0.00	0.00	0.00	0.00	0.00
10	0.45	0.39	0.42	0.42	0.42
15	0.90	0.71	0.69	0.38	0.69
20	0.66	0.68	0.77	0.21	0.77
30	0.14	0.14	0.37	0.39	0.37
40	1.42	1.45	1.55	0.67	1.55
50	1.38	1.43	1.43	0.43	1.43
60	0.20	0.22	0.22	0.20	0.22
Average	0.47	0.46	0.49	0.25	0.49

The obtained results confirmed our expectations. Based on presented values, it was found that the computational time of the covering approaches is approximately ten times smaller in comparison with the exact method used for Slovak self-governing region instances. Simply said, the approximate covering method provides the solution much faster than the exact one. It can be considered very useful mainly in larger weighted p -median problem instances. As concerns the gaps, presented results are very satisfactory. In most cases, the average gaps stay below 1 percent. Taking into account the average over all tested values of the ratio $|I|/p$ in the Table 4, we can conclude that little improvement is possible by suitable determination of parameter α , when the combination of both criteria in the distance relevance estimation (22) is employed. The most suitable value of α seems to be 0.6.

6 CONCLUSIONS

In this paper an improved approximate covering approach with shifted exponential distance value relevance estimation was introduced. The substantial contribution of suggested method consists in analyzing of the dependence of the customers' demands to the quality of resulting public service system design. Also a new concept of distance relevance combining two different criteria was studied. The effectiveness of suggested approach depends on the parameter α , which has to be set in a proper way to obtain a solution of good accuracy. To summarize the results, we have constructed an improved solving method for public service system design problem, which does not need any ad-hoc settings of input parameters. We found that the computational time of suggested algorithm is on average ten times smaller in comparison with the exact method. The accuracy of the approximate approach is very good. Thus we can conclude that we have presented a useful tool for large public service system design, which can be implemented using common commercial optimization software.

Acknowledgements: This work was supported by the research grants VEGA 1/0296/12 “Public Service Systems with Fair Access to Service”, APVV-0760-11 “Designing of Fair Service Systems on Transportation Networks” and also by the following project: University Science Park of the University of Žilina (ITMS: 26220220184) supported by the Research & Development Operational Program funded by the European Regional Development Fund.

References

- [1] Avella, P., Sassano, A. and Vassil'ev, I. (2007) ‘Computational study of large scale p-median problems’, *Mathematical Programming*, vol. 109, pp. 89-114.
- [2] Current, J., Daskin, M. and Schilling, D. (2002) ‘Discrete network location models’, in Drezner Z. (ed.) *Facility location. Applications and theory*, Berlin: Springer, pp. 81-118.
- [3] García, S., Labbé, M. and Marín, A. (2011) ‘Solving large p-median problems with a radius formulation’, *INFORMS Journal on Computing*, vol. 23, no. 4, pp. 546-556.
- [4] Ingolfsson, A., Budge, S. and Erkut, E. (2008). ‘Optimal ambulance location with random delays and travel times’, *Health Care management science*, vol. 11, no. 3, pp. 262-274.
- [5] Janáček, J. (2008) ‘Approximate Covering Models of Location Problems’, *ICAOR '08 – Conference Proceedings*, 1st International Conference on Applied Operational Research, Yerevan, Armenia, pp.53-61.
- [6] Janáček, J. and Kvet, M. (2011) ‘Approximate solving of large p-median problems’, *ORP3-Operational research peripatetic post-graduate programme – Conference Proceedings*, Cádiz, Spain, pp. 221-225.
- [7] Janáček, J. and Kvet, M. (2014) ‘Public service system design by radial formulation with dividing points’, *Central European Journal of Operations Research*, Springer, to appear.
- [8] Janáček, J. and Kvet, M. (2013) ‘Public service system design with disutility relevance estimation’, *Mathematical Methods in Economics 2013 – Conference Proceedings*, The Czech Society for Operations Research Conference, Jihlava, Czech Republic, pp. 332-337.
- [9] Janáček, J. and Kvet, M. (2012) ‘Relevant Network Distances for Approximate Approach to Large p-Median Problems’, *Operations research proceedings 2012: selected papers of the international conference on operations research*, Hannover, Germany, Berlin Heidelberg: Springer-Verlag, pp. 123-128.
- [10] Janáček, J., Linda, B. and Ritschelová, I. (2010) ‘Optimization of Municipalities with Extended Competence Selection’, *Prager Economic Papers-Quarterly Journal of Economic Theory and Policy*, vol. 19, no. 1, pp. 21-34.
- [11] Janáčková, M. and Szendreyová, A. (2006) ‘An impact of set of centers of distribution system design problem on computational time of solving algorithm’, in Mikulski, J. (ed). *Advances in Transport Systems Telematics*, Katowice, pp. 109-112.
- [12] Jánošíková, E. (2007) ‘Emergency Medical Service Planning’, *Communications – Scientific Letters of the University of Žilina*, vol. 9, no. 2, pp. 64-68.

Authors' addresses

Ing. Marek Kvet, PhD.

University of Žilina - University Science Park

Univerzitná 8215/1, 010 26 Žilina, Slovakia

Email: marek.kvet@uniza.sk

Prof. RNDr. Jaroslav Janáček, CSc.

University of Žilina - Faculty of Management Science and Informatics

Univerzitná 8215/1, 010 26 Žilina, Slovakia

Email: jaroslav.janacek@fri.uniza.sk

SEVERAL ATTITUDES TO A FAIR DOUBLE RATE ON A BUS LINE

*Tomáš Majer, Stanislav Palúch,
University of Žilina*

Abstract

The paper studies possibilities how to design a fair double tariff on a bus line. Several measures of unfairness are introduced, methods of minimization of unfairness are proposed and the results on real life data are compared.

Keywords: *tariff system, single tariff, fair double tariff, constrained extreme problem*

JEL Classification: C61

AMS Classification: 90B06

1. INTRODUCTION

The problem how to determine a tariff on urban bus transport is widely discussed in many papers. An economical attitude to fares is presented by Černá and Černý in [2] and [3]. This paper studies the problem of tariff design in larger urban regular passenger transport where travel distances of passengers differ significantly. The simplest way is to establish a single tariff regardless of traveled distance. Some passengers travel along long distances while another ones along short trips. Such a single tariff is advantageous for the first mentioned passengers. However, a single tariff is inconvenient for short trip passengers. Hamacher and Schöbel tried to solve this problem by dividing serviced area into zones in [4] and [8]. Similar attitude together with assessing impact to passenger demand is in Koháni [5] and [6]. An economic profit has been taken as objective till now. Bertsimas, Farias and Trichakis [1] introduced a new objective – a notion of fairness. One way how to improve fairness is to introduce a double tariff – fare x for passengers travelling at most along k laps and fare y for passengers travelling along more than k laps. Just mentioned approach was presented in [7] by Palúch using the sum of squared differences between ideal and double fare of all passengers as the objective function. This paper is a generalization of the attitude introduced in [3] which studies alternative objectives and compares results on real data.

2. GENERAL MATHEMATICAL MODEL

Suppose we are given a bus line L with n bus stops. Lap of a line L is a segment of a bus line between two successive bus stops. Suppose, we are given a line L and the following input data

R_i – The number of passengers travelling exactly along i laps of the line L

t_i – ideal, but from some reasons infeasible fair distance tariff for passengers travelling along exactly i laps of the line –

Let x and y be unknown variables with the following meaning:

x – double tariff fare for passengers traveling along at most k laps

y – double tariff fare for passengers traveling along more than k laps

Total fare on line L in the case of ideal fair tariff is

$$F = \sum_{i=1}^{n-1} t_i R_i \quad (1)$$

Total fare on line L in the case of double tariff is

$$F_d = \sum_{i=1}^k x R_i + \sum_{j=k+1}^{n-1} y R_j = x \sum_{i=1}^k R_i + y \sum_{j=k+1}^{n-1} R_j = x S_k + y L_k, \quad (2)$$

where $S_k = \sum_{i=1}^k R_i$ is the total number of passengers travelling at most along k laps and $L_k = \sum_{j=k+1}^{n-1} R_j$ is the total number of passengers travelling more than along k laps.

Bus provider wants to keep the income from double tariff same as the one from ideal fair tariff, i.e.:

$$F = F_d \tag{3}$$

from what it follows:

$$F = \sum_{i=1}^{n-1} t_i R_i = \sum_{i=1}^k x R_i + \sum_{j=k+1}^{n-1} y R_j = x S_k + y L_k \tag{4}$$

Let u_i be the unfairness of a passenger travelling along exactly i laps. Unfairness of a short distance passenger is a function of x , t_i and k , i.e. $u_i = f(x, t_i, k)$, unfairness of a long distance passenger is a function of y , t_i and k , i.e. $u_i = f(y, t_i, k)$. Unfairness of all passengers travelling along exactly i laps equals to $R_i u_i$. Denote by $U(x, y, k)$ the total unfairness of all passenger travelling along considered line.

$$U(x, y, k) = \sum_{i=1}^{n-1} R_i u_i = \sum_{i=1}^k R_i u_i + \sum_{j=k+1}^{n-1} R_j u_j = \sum_{i=1}^k R_i f(x, t_i, k) + \sum_{j=k+1}^{n-1} R_j f(y, t_j, k)$$

To minimize $U(x, y, k)$ for a fixed k means to solve the following optimization problem

Minimize

$$U(x, y, k) = \sum_{i=1}^k R_i f(x, t_i, k) + \sum_{j=k+1}^{n-1} R_j f(y, t_j, k) \tag{5}$$

Subject to

$$x S_k + y L_k = F, \quad x \geq 0, \quad y \geq 0 \tag{6}$$

Searching for a fair double rate for a bus line with n bus stops is the following two-stage procedure:

Step 1: For $k = 1, 2, \dots, n - 2$ find x_k – a fair double tariff fare for passengers traveling along at most k laps and y_k – a fair double tariff fare for passengers travelling along more than k laps minimizing unfairness (1).

Step 2: Find $k \in \{1, 2, \dots, n - 2\}$ for which is $U(x_k, y_k, k)$ minimum.

3. MEASURES OF UNFAIRNESS

There are several ways how to express unfairness $u_i(z) = f(z, t_i, k)$ of a single passenger travelling along exactly i laps with the fare equal to z instead of ideal fare t_i .

$$1. \quad u_i(z) = f(z, t_i, k) = t_i - z. \text{ In this case } U(x, y, k) = \sum_{i=1}^k R_i (t_i - x) + \sum_{j=k+1}^{n-1} R_j (t_j - y) = \sum_{i=1}^k R_i t_i + \sum_{j=k+1}^{n-1} R_j t_j - x \sum_{i=1}^k R_i - y \sum_{j=k+1}^{n-1} R_j = F - x S_k - y L_k.$$

The objective function $F - x S_k - y L_k$ is equal to 0 for any feasible pair x, y satisfying the constraint $x S_k + y L_k = F$.

Therefore the result of such minimization is useless.

2. $u_i(z) = f(z, t_i, k) = |t_i - z|$
3. $u_i(z) = f(z, t_i, k) = \max\{0, (t_i - z)\}$
4. $u_i(z) = f(z, t_i, k) = (t_i - z)^2$

3.1. Case $u_i(z) = f(z, t_i, k) = |t_i - z|$

In this case we have the following minimization problem:

Minimize

$$U(x, y, k) = \sum_{i=1}^k R_i |t_i - x| + \sum_{j=k+1}^{n-1} R_j |t_j - y| \tag{7}$$

Subject to

$$x S_k + y L_k = F, \quad x \geq 0, \quad y \geq 0 \tag{8}$$

It follows from the last constraint: $y = \frac{F - x S_k}{L_k}$.

Then

$$U(x, y, k) = V(x) = \sum_{i=1}^k R_i |t_i - x| + \sum_{j=k+1}^{n-1} R_j \left| t_j - \frac{F - xS_k}{L_k} \right| \quad (9)$$

$V(x)$ (9) is a continuous and piecewise linear function of x . The first derivation of $V(x)$ does not exist if $(t_i - x) = 0$ or $\left(t_j - \frac{F - xS_k}{L_k}\right) = 0$.

Therefore it acquires an extreme at one of at most $(n - 1)$ values x where:

$x = t_i$ and $t_i - \frac{F - xS_k}{L_k} \geq 0$ for some $i = 1, 2, \dots, k$ or $x = \frac{F - t_j L_k}{S_k} \geq 0$ and for some $j = k + 1, k + 2, \dots, n - 1$.

Another way how to solve this problem is to convert it into linear programming problem:

Minimize

$$U(x, y, k) = \sum_{i=1}^k R_i w_i + \sum_{j=k+1}^{n-1} R_j z_j \quad (10)$$

Subject to

$$w_i \geq t_i - x \quad \text{for } i = 1, 2, \dots, k \quad (11)$$

$$w_i \geq x - t_i \quad \text{for } i = 1, 2, \dots, k \quad (12)$$

$$z_j \geq t_j - y \quad \text{for } j = k + 1, k + 2, \dots, n - 1 \quad (13)$$

$$z_j \geq y - t_j \quad \text{for } j = k + 1, k + 2, \dots, n - 1 \quad (14)$$

$$xS_k + yL_k = F, \quad x \geq 0, \quad y \geq 0 \quad (15)$$

$$w_i \geq 0 \quad \text{for } i = 1, 2, \dots, k, \quad z_j \geq 0 \quad \text{for } j = k + 1, k + 2, \dots, n - 1 \quad (16)$$

A reader may feel that this is too strong mathematical tool for such a simple task. This is true for just studied problem. However, this model can be useful for further work – a generalization of studied problem for three or more rates.

3.2. Case $u_i(z) = f(z, t_i, k) = \max\{0, (t_i - z)\}$

The corresponding unfairness minimization problem has the following mathematical model:

Minimize

$$U(x, y, k) = \sum_{i=1}^k R_i \max\{0, (t_i - x)\} + \sum_{j=k+1}^{n-1} R_j \max\{0, (t_j - y)\}$$

Subject to

$$xS_k + yL_k = F, \quad x \geq 0, \quad y \geq 0$$

Substitution $y = \frac{F - xS_k}{L_k}$ yields

$$U(x, y, k) = W(x) = \sum_{i=1}^k R_i \max\{0, (t_i - x)\} + \sum_{j=k+1}^{n-1} R_j \max\left\{0, \left(t_j - \frac{F - xS_k}{L_k}\right)\right\} \quad (17)$$

Similarly as in the last studied unfairness function $U(x)$, the function $W(x)$ (17) is a continuous and piecewise linear function of x with the same points where the first derivation does not exist, i.e. with the same points suspicious of acquiring maximum or minimum. Therefore it suffices to check for minimum following points:

$x = t_i$ where $t_i - \frac{F - xS_k}{L_k} \geq 0$ for $i = 1, 2, \dots, k$

and

$$x = \frac{F - t_j L_k}{S_k} \geq 0 \quad \text{for } j = k + 1, k + 2, \dots, n - 1.$$

A linear programming model can be written for just studied problem similarly as in the last studied unfairness function – minimize (10) subject to (11), (13), (15) and (16).

3.3. Case $u_i(z) = f(z, t_i, k) = (t_i - z)^2$

Mathematical model to minimize total unfairness $u_i(z) = (t_i - z)^2$ is:

Minimize

$$U(x, y) = \sum_{i=1}^k R_i(x - t_i)^2 + \sum_{j=k+1}^{n-1} R_j(y - t_j)^2 \quad (18)$$

Subject to

$$xS_k + yL_k = F, \quad x \geq 0, \quad y \geq 0 \quad (19)$$

This formulation is a constrained extreme problem solvable by Lagrange Multiplier Method.

Denote

$$F(x, y, \lambda) = U(x, y) - \lambda(xS_k + yL_k - F)$$

$$F(x, y, \lambda) = \sum_{i=1}^k R_i(x - t_i)^2 + \sum_{j=k+1}^{n-1} R_j(y - t_j)^2 - \lambda(xS_k + yL_k - F) \quad (20)$$

Formula (20) for $U(x, y)$ defines a differentiable function on R^2 (where R is the set of all real numbers). The Lagrange Multiplier Theorem asserts that if $U(x, y)$ achieves a minimum on R^2 subject to (2), then the minimum is necessarily achieved at a point where

$$\frac{\delta F(x, y, \lambda)}{\delta x} = 0, \quad \frac{\delta F(x, y, \lambda)}{\delta y} = 0 \quad \text{and} \quad \frac{\delta F(x, y, \lambda)}{\delta \lambda} = 0.$$

Let us see where Lagrange Multiplier method tells us to look for optimal solution. It holds:

$$\frac{\delta F(x, y, \lambda)}{\delta x} = 2 \sum_{i=1}^k R_i(x - t_i) - \lambda S_k = 2x \sum_{i=1}^k R_i - 2 \sum_{i=1}^k R_i t_i - \lambda S_k = 0$$

$$\frac{\delta F(x, y, \lambda)}{\delta y} = 2 \sum_{j=k+1}^{n-1} R_j(y - t_j) - \lambda L_k = 2y \sum_{j=k+1}^{n-1} R_j - 2 \sum_{j=k+1}^{n-1} R_j t_j - \lambda L_k = 0$$

$$\frac{\delta F(x, y, \lambda)}{\delta \lambda} = xS_k + yL_k - F = 0 \quad (21)$$

Remember that $S_k = \sum_{i=1}^k R_i$ and $L_k = \sum_{j=k+1}^{n-1} R_j$. Therefore

$$\frac{\delta F(x, y, \lambda)}{\delta x} = 2xS_k - 2 \sum_{i=1}^k R_i t_i - \lambda S_k = 0 \quad (22)$$

$$\frac{\delta F(x, y, \lambda)}{\delta y} = 2yL_k - 2 \sum_{j=k+1}^{n-1} R_j t_j - \lambda L_k = 0 \quad (23)$$

It follows from (22) and (23)

$$x = \frac{2 \sum_{i=1}^k t_i R_i + \lambda S_k}{2S_k} = \frac{\sum_{i=1}^k t_i R_i}{2S_k} + \frac{\lambda}{2} \quad (24)$$

$$y = \frac{2 \sum_{j=k+1}^{n-1} t_j R_j + \lambda L_k}{2L_k} = \frac{\sum_{j=k+1}^{n-1} t_j R_j}{L_k} + \frac{\lambda}{2} \quad (25)$$

We obtain by substitution for x from (24) and for y from (25) into (21)

$$\left(\frac{\sum_{i=1}^k t_i R_i}{S_k} + \frac{\lambda}{2} \right) \cdot S_k + \left(\frac{\sum_{j=k+1}^{n-1} t_j R_j}{L_k} + \frac{\lambda}{2} \right) \cdot L_k = F$$

The last equation can be stepwise simplified as follows:

$$\sum_{i=1}^k t_i R_i + \frac{\lambda}{2} S_k + \sum_{j=k+1}^{n-1} t_j R_j + \frac{\lambda}{2} L_k = F$$

$$\left(\sum_{i=1}^k t_i R_i + \sum_{j=k+1}^{n-1} t_j R_j \right) + \left(\frac{\lambda}{2} S_k + \frac{\lambda}{2} L_k \right) = F$$

$$\sum_{i=1}^{n-1} t_i R_i + \frac{\lambda}{2} (S_k + L_k) = F$$

Since $\sum_{i=1}^{n-1} t_i R_i = F$ we have

$$F + \frac{\lambda}{2} (S_k + L_k) = F$$

$$\frac{\lambda}{2} (S_k + L_k) = 0$$

$$\lambda = 0$$

Substitution 0 for λ into (6) and (7) gives

$$x = \frac{\sum_{i=1}^k t_i R_i}{S_k} = \frac{\sum_{i=1}^k t_i R_i}{\sum_{i=1}^k R_i}, \quad y = \frac{\sum_{j=k+1}^{n-1} t_j R_j}{L_k} = \frac{\sum_{j=k+1}^{n-1} t_j R_j}{\sum_{j=k+1}^{n-1} R_j}. \quad (26)$$

To guarantee that the function $U(x, y)$ achieves minimum at point (26) it is necessary to show that following second partial derivatives are greater than zero.

Indeed, it holds:

$$\frac{\delta^2 F(x, y, \lambda)}{\delta x^2} = 2S_k > 0, \quad \frac{\delta^2 F(x, y, \lambda)}{\delta y^2} = 2L_k > 0$$

Let us define for $k = 1, 2, \dots, n-1$

$$U^*(k) = \sum_{i=1}^k R_i \left(\frac{\sum_{i=1}^k t_i R_i}{\sum_{i=1}^k R_i} - t_i \right)^2 + \sum_{j=k+1}^{n-1} R_j \left(\frac{\sum_{j=k+1}^{n-1} t_j R_j}{\sum_{j=k+1}^{n-1} R_j} - t_j \right)^2 \quad (27)$$

$U^*(k)$ is the least possible unfairness provided that double tariff uses one fare for passengers travelling less or equal then k laps and another fare for the ones travelling more then k laps.

The optimum k can be found by searching the set

$$\{U^*(1), U^*(2), \dots, U^*(n-1)\}$$

for minimum. Therefore the optimum k is

$$k = \operatorname{argmin}\{U^*(1), U^*(2), \dots, U^*(n-1)\} \quad (28)$$

Corresponding optimum fares x, y are determined by equations (26).

4. EXPERIMENTS

We use real data from public transport of Slovak town Martin to compute optimum double fares for all cases of unfairness. Public transport system in Martin serves circa 40,000 passengers in one working day. The longest trip has 26 stops and histogram of traveling distance (number of traveling stops) is shown in Figure 1.

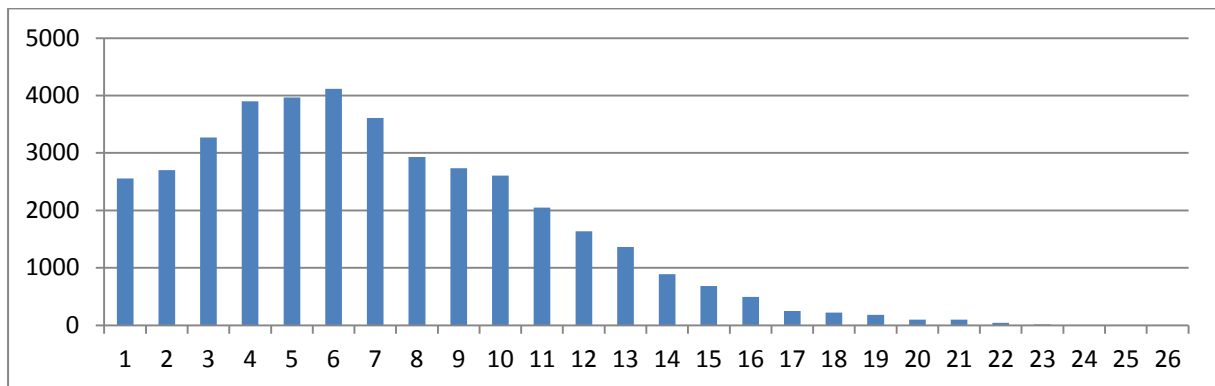

Figure 1: Histogram of traveling distances of passengers in Martin

4.1. Ideal fare

We have exactly 40,409 sold tickets in our dataset and the price of a basic ticket in Martin single tariff public transport system is 0.60 € today. Then total receipts without discounts is 24,245.40 €. Let fixed and variable costs are divided in ratio 50:50. Then ideal fare for passenger i traveling d_i loops can be computed with formula $c_i = 0.30 + 0.0426d_i$.

4.2. Case $u_i(z) = f(z, t_i, k) = |t_i - z|$

Some of values of computed double fares with fairness $|t_i - z|$ are shown in Table 1. The optimal lower fare x for no more than 6 loops is 0.47 € and optimal higher fare y for 7 and more loops is 0.74 €. But the difference between fairness of fare border 6 and 7 loops is very small.

Table 1: Double fares calculated using $u_i(z) = |t_i - z|$

k	t[k]	R[k]	S[k]	L[k]	x[k]	y[k]	U[k]
5	0.51 €	3 965	16 384	24 025	0.47 €	0.69 €	3 427.9
6	0.56 €	4 115	20 499	19 910	0.47 €	0.74 €	3 230.4
7	0.60 €	3 610	24 109	16 300	0.49 €	0.77 €	3 230.6
8	0.64 €	2 932	27 041	13 368	0.51 €	0.78 €	3 268.3
9	0.68 €	2 735	29 776	10 633	0.53 €	0.81 €	3 461.8

4.3. Case $u_i(z) = f(z, t_i, k) = \max\{0, (t_i - z)\}$

Optimal double fares with fairness $\max\{0, (t_i - z)\}$ are shown in Table 2 and are not different from previous one.

Table 2: Double fares calculated using $u_i(z) = \max\{0, (t_i - z)\}$

k	t[k]	R[k]	S[k]	L[k]	x[k]	y[k]	U[k]
5	0.51 €	3 965	16 384	24 025	0.47 €	0.69 €	1 714.0
6	0.56 €	4 115	20 499	19 910	0.47 €	0.74 €	1 615.2
7	0.60 €	3 610	24 109	16 300	0.49 €	0.77 €	1 615.3
8	0.64 €	2 932	27 041	13 368	0.51 €	0.78 €	1 634.2
9	0.68 €	2 735	29 776	10 633	0.53 €	0.81 €	1 730.9

4.4. Case $u_i(z) = f(z, t_i, k) = (t_i - z)^2$

Optimal double fares with fairness $(t_i - z)^2$ are shown in Table 3. The optimal lower fare x for no more than 8 loops is 0.50 € and optimal higher fare y for 9 and more loops is 0.80 €.

Table 3: Double fares calculated using $u_i(z) = (t_i - z)^2$

k	t[k]	R[k]	S[k]	L[k]	x[k]	y[k]	U[k]
7	0.60 €	3 610	24 109	16 300	0.48 €	0.77 €	408.4
8	0.64 €	2 932	27 041	13 368	0.50 €	0.80 €	407.7
9	0.68 €	2 735	29 776	10 633	0.52 €	0.84 €	434.7
10	0.73 €	2 605	32 381	8 028	0.53 €	0.87 €	504.6

Comparison of all fairness functions for fare border of 7 loops is shown in Figure 2.

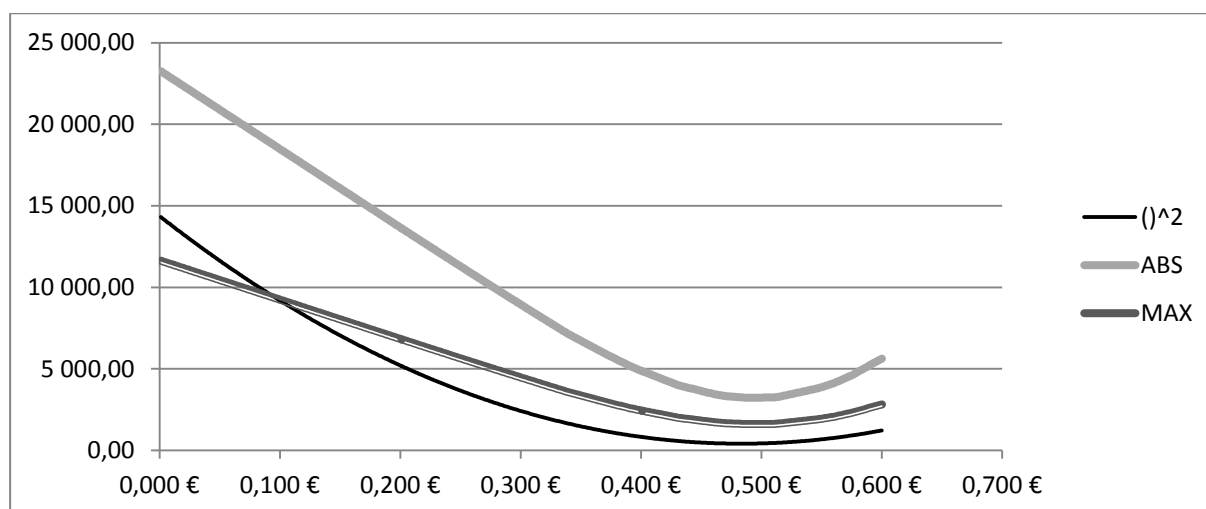

Figure 2: Fairness function dependence on fare x for fare border of 7 loops

Acknowledgements: This work was supported by the research grant APVV-0760-11 “Designing of Fair Service Systems on Transportation Networks” and VEGA 1/0296/12 “Public Service Systems with Fair Access to Service”.

References

- [1] Bertsimas, D., Farias, V.F. and Trichakis, N. (2011) ‘The price of fairness’, *Operations Research*, vol. 59, no. 1, pp. 17-31.
- [2] Černá, A. and Černý, J. (2004) *Teorie řízení a rozhodování v dopravních systémech*, Jan Perner Institut.
- [3] Černá, A. (1999) ‘Optimalizace tarifů - časové jízdenky’, *Sci. Pap. U. of Pardubice, část B*, vol. 4, pp. 267-270.
- [4] Hamacher, H.W. and Schöbel, A. (2004) ‘Design of Zone Tariff Systems in Public Transportation’, *Operations Research*, vol. 52, no. 6, November–December, pp. 897–908.
- [5] Koháni, M. (2013) ‘Zone partitioning problem with given prices and number of zones in counting zones tariff system’, *SOR '13: 12th International Symposium on Operational Research – Conference Proceedings*, Dolenjske Toplice, Slovenia, pp. 75-80.
- [6] Koháni, M. (2013) ‘Impact of changes in fares and demand to the tariff zones design’, *Mathematical Methods in Economics 2013 – Conference Proceedings*, The Czech Society for Operations Research Conference, Jihlava, pp. 417-422.
- [7] Palúch, S. (2013) ‘On a fair fare rating on a bus line’, *Communications: Scientific Letters of the University of Žilina*, vol. 15, no. 1, pp. 25-28.
- [8] Schöbel, A. (1996) ‘Zone planning in public transportation’. in Bianco, L. and Toth, P. (ed.) *Advanced Methods in Transportation Analysis*, Berlin: Springer Verlag, pp. 117–134.

Author’s address

Ing. Tomáš Majer, PhD.

University of Žilina, Faculty of Management Science and Informatics, Department of Mathematical Methods, Univerzitná 8215/1, 010 26 Žilina Slovak Republic

Email: tomas.majer@uniza.sk

Doc. RNDr, Stanislav Palúch, CSc.

University of Žilina, Faculty of Management Science and Informatics, Department of Mathematical Methods, Univerzitná 8215/1, 010 26 Žilina Slovak Republic

Email: stanislav.paluch@uniza.sk

MIXTURE OF JOHNSON DISTRIBUTION

*Luboš Marek, Michal Vrabec,
University of Economics, Prague*

Abstract

This article explores the possibility of modeling the wage distribution using a mixture densities Johnson's distribution. The idea of using a mixture distribution (instead of using one classical density), the authors studied in previous articles. Authors tried a mixture of normal and then a mixture of lognormal probability densities. The achieved results were very good from the beginning, especially when using lognormal density. Data on wages are available for the last 15 years. During this time the characteristics of the wage empirical distribution were changed. Variability of data grew, skewness and kurtosis were changed over time, too. Changing the parameters of probability density over time has led to a degradation of the model and it was necessary to choose a different probability distribution. The mixture of Johnson distribution has proved best.

Keywords: *probability, probability model, wage distribution, Johnson distribution, Johnson mixture of densities*

JEL Classification: C44

AMS Classification: 90C15

1 JOHNSON TRANSFORMATION

In this chapter we utilize results and theory described in papers [4], [5], [6], [7], [8] and [14]. We suppose that we work with continuous random variable X and that probability distribution function of this random variable is unknown. We need approximate this random variable. Johnson proposed three normalizing transformations in the general form:

$$Z = \gamma + \delta f\left(\frac{X - \theta}{\sigma}\right) \quad (1)$$

where Z is standard normal random variable, f is the appropriate transformation function, σ is a scale parameter and θ is a location parameter. The parameters γ and δ are shape parameters such that $\delta > 0$ and $\sigma > 0$.

The first transformation proposed by Johnson defines the lognormal system of distributions denoted by S_L

$$Z = \gamma + \delta f\left(\frac{X - \theta}{\sigma}\right), \quad X > \mu \quad (2)$$

We can rewrite this equation to the form

$$Z = \gamma' + \delta f(X - \mu), \quad X > \mu \quad (3)$$

The capital letter L denotes system of lognormal family. Under above assumptions can be derived the equation of probability density function for the family in the Johnson system. If X

follows the Johnson distribution and $Y = \frac{X - \theta}{\sigma}$, probability density function has the form

$$p(y) = \frac{\delta}{\sqrt{2\pi}} \cdot \frac{1}{y} \cdot \exp\left[-\frac{1}{2}(\gamma + \delta \ln(y))^2\right], \quad \theta < x < \infty \quad (4)$$

The second system of distributions S_B is bounded and is defined by

$$Z = \gamma + \delta \ln\left(\frac{X - \theta}{\theta + \sigma - X}\right), \quad \theta < X < \theta + \sigma \quad (5)$$

S_B curves cover bounded distributions. The distributions can be bounded on the lower end, the upper end or both ends. This family covers Gamma distributions, Beta distributions and many others. The appropriate probability density function for this family has the form (under above assumptions)

$$p(y) = \frac{\delta}{\sqrt{2\pi}} \cdot \frac{1-y}{y} \cdot \exp\left[-\frac{1}{2}\left(\gamma + \delta \ln\left(\frac{y}{1-y}\right)\right)^2\right], \quad \theta < x < \theta + \sigma \quad (6)$$

The third system is unbounded system of distributions S_U and is defined as

$$Z = \gamma + \delta \ln\left\{\left(\frac{X-\theta}{\sigma}\right) + \left[\left(\frac{X-\theta}{\sigma}\right)^2 + 1\right]^{1/2}\right\}, \quad -\infty < X < \infty \quad (7)$$

The S_U curves are unbounded and cover the t and normal distributions. The appropriate probability density function for S_U family has the form (under above assumptions)

$$p(y) = \frac{\delta}{\sqrt{2\pi}} \cdot \frac{1}{\sqrt{y^2+1}} \cdot \exp\left[-\frac{1}{2}\left(\gamma + \delta \ln\left(y + \sqrt{y^2+1}\right)\right)^2\right], \quad -\infty < x < \infty \quad (8)$$

We can write general form of probability density function for random variable X as

$$\begin{aligned} f'(y) &= \frac{1}{y}, && \text{for } S_L \text{ family,} \\ &= \frac{1}{y(1-y)}, && \text{for } S_B \text{ family,} \\ &= \frac{1}{\sqrt{y^2+1}}, && \text{for } S_U \text{ family.} \end{aligned} \quad (9)$$

and

$$\begin{aligned} f(y) &= \ln(y), && \text{for } S_L \text{ family,} \\ &= \ln\left(\frac{y}{1-y}\right), && \text{for } S_B \text{ family,} \\ &= \ln\left(y + \sqrt{y^2+1}\right), && \text{for } S_U \text{ family.} \end{aligned} \quad (10)$$

We need estimate unknown parameters in probability distribution function for each Johnson family. We use percentiles. Percentiles matching involves estimating k required parameters by matching k selected quantiles of the standard normal distribution with corresponding quantile estimates of the target population. For given percentages $\{\alpha_j; 1 \leq j \leq k\}$, the corresponding quantiles $\{z_{\alpha_j}\}$ and $\{x_{\alpha_j}\}$ are given by

$$z_{\alpha_j} = \Phi^{-1}(\alpha_j) \quad (11)$$

and

$$x_{\alpha_j} = F^{-1}(\alpha_j) \quad (12)$$

where Φ is the standard normal distribution function and F is the target distribution function. Once the functional form f among systems given by equations (2) - (4) has been identified, the method of percentile matching attempts to solve the k equations

$$z_{\alpha_j} = \gamma + \delta \cdot f\left(\frac{\hat{x}_{\alpha_j} - \theta}{\sigma}\right), \quad 1 \leq j \leq k \quad (13)$$

where \hat{x}_{α_j} is an estimator of the quantile x_{α_j} based on sample data. Slifker and Shapiro in [13] introduced a selection rule, which is a function of four percentiles for selecting one of the three

families, to give estimates of the Johnson parameters. The fit parameters for the transformation are calculated by solving the transformation equation for the chosen distribution type at the four selected percentiles. Choose any fixed value z ($1 < z < 0$) of a standard normal variate; the four points $\pm z$ and $\pm 3z$ determine three intervals of equal length. Determine the percentile P_α corresponding to $\alpha = 3z, z, -z, -3z$ respectively. For example, if $z = 0,5$ then $P_{0,5} = 0.6915 \cdot 100 = 69.15$. Let $x_{3z}, x_z, x_{-z}, x_{-3z}$ be the percentiles of data values corresponding to the four selected percentiles of the normal distribution. The type of Johnson distribution chosen is based on the value of the discriminant d calculated as

$$d = \frac{m \cdot n}{p^2} \tag{14}$$

where

$$p = x_z - x_{-z}, m = x_{3z} - x_z, n = x_{-z} - x_{-3z}, \tag{15}$$

If the calculated value d is greater than 1.001, then an unbounded distribution is chosen; if the value is less than 0.999, then a bounded. The parameter estimates for the S_B distribution are

$$\hat{\delta} = \frac{z}{\cosh^{-1} \left[\frac{1}{2} \left[\left(1 + \frac{p}{m} \right) \left(1 + \frac{p}{n} \right) \right]^{\frac{1}{2}} \right]}, (\delta > 0) \tag{16}$$

$$\hat{\gamma} = \hat{\delta} \sinh^{-1} \left[\frac{\left(\frac{p}{n} - \frac{p}{m} \right) \left[\left(1 + \frac{p}{m} \right) \left(1 + \frac{p}{n} \right) - 4 \right]^{\frac{1}{2}}}{2 \left(\frac{p}{n} \frac{p}{m} - 1 \right)} \right], \tag{17}$$

$$\hat{\sigma} = \frac{p \left[\left\{ \left(1 + \frac{p}{m} \right) \left(1 + \frac{p}{n} \right) - 2 \right\}^2 - 4 \right]^{\frac{1}{2}}}{\frac{p}{n} \frac{p}{m} - 1}, \tag{18}$$

and

$$\hat{\mu} = \frac{x_z + x_{-z}}{2} - \frac{\sigma}{2} + \frac{p}{2} \cdot \frac{\left(\frac{p}{n} - \frac{p}{m} \right)}{\left(\frac{p}{m} \frac{p}{n} - 1 \right)} \tag{19}$$

2 WAGES IN CZECH REPUBLIC

We work with time series of wages in Czech Republic in the years from 1995 to 2012. The annual data is reported in quarterly units; our study observes the average wages in the second quarter of each year. The scope of the data set on which the analyses were carried out was gradually increased from more than 300,000 observations in 1995 to approximately two million in 2012. This data is structured in a very detailed way. The salary values are divided into intervals whose widths are 500 CZK. Such a detailed structure enables us to achieve quite accurate results. We have at our disposal basic characteristics of wages in the entire period under consideration: arithmetic mean, standard deviation, median, upper and lower quartiles and 10% and 90% quantiles. In particular, the arithmetic mean and standard deviation are very important for us – without those we would not have been able to estimate the density of probability distribution for wages. The said characteristics were calculated for the entire Czech Republic and

also in categories by gender, age (with three groups: up to 30 years; 30 to 50 years; and above 50 years of age), and regions.

The analyses were aimed at formulating a model for probability distribution of wages (estimating the shape of the probability density). We are then able to work with this model and use it for subsequent calculations – whether predicting the future shape of the distribution, determining the confidence intervals, predicting characteristics of wages, etc. Most calculations were carried out with the aid of SAS software using literature [15]. Modeling wages in the Czech Republic is engaged in work [1], [2], [9], [10], [11] and [12].

2.1 Data set

We can see the data intervals (500 CZK wide) an example in Table 1.

lower bound	upper bound	absolute frequency
21,000	- 21,500	51,409
21,500	- 22,000	50,775
22,500	- 23,000	47,631

Such a detailed structure enables us to achieve quite accurate calculations. It is very easy to calculate the empirical frequency. We use the empirical frequency for construction of the next figure (frequency polygon).

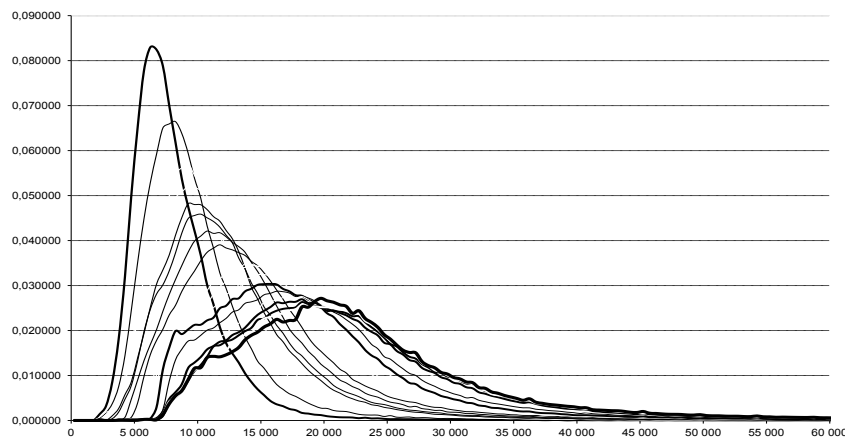

Figure 1: Empirical distribution of wages over time

Let us view the frequency distributions for average wages in each year for the entire Czech Republic over time period 1995 - 2012. It is obvious that the distribution's location, variability, skewness and kurtosis significantly change between years. In the early years the shape of the distribution is relatively smooth, while in the later years the empirical density's curve is much less smooth – this is above all, a consequence of the growing variability.

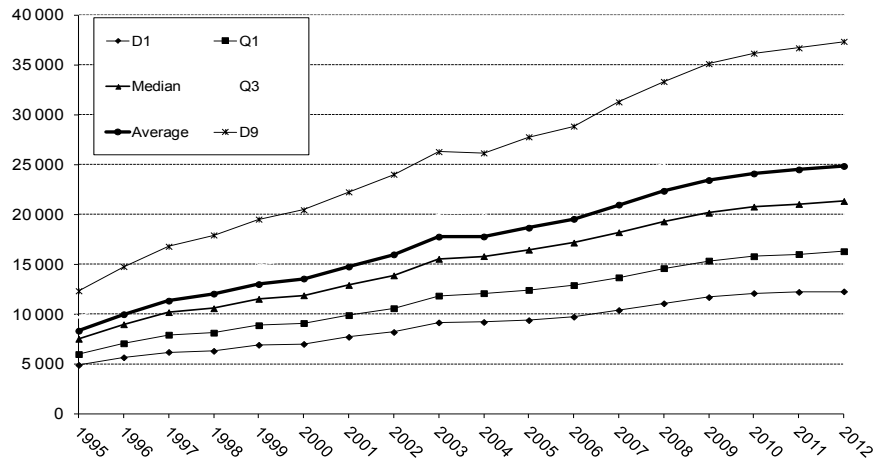

Figure 2: Average and important percentiles of wages

The Figure 2 shows the wage average and values of significant percentiles. We can see that the trend over time is strictly linear. The knowledge of these characteristics is very important for us, because we use them when we will estimate theoretical parameters of probability distribution.

2.2 Empirical distribution of wages

We find the appropriate probability density function for our data. The authors used logarithmic-normal distribution in the past. Other distributions could also be used, of course, such as Log-Logistic, Burr, or Frechet. However, with the growing variability in later years the results achieved with the aid of classical distributions are less and less accurate.

In our opinion, the situation can be resolved using the so-called mixtures of probability distribution functions. The main idea is based on the fact that the average wage over the entire Czech Republic is a composition of average wages for different categories with different weights. The probability distribution in each category is of the same type, but their parameters – and consequently the density shapes – are different. We treated constructions based on the normal distributions and log-normal distributions in [12]. The results were very good in beginning but the resulting models were getting worse in more recent years. From this reason we suggest using of Johnson transformation and the mixture of the Johnson distributions.

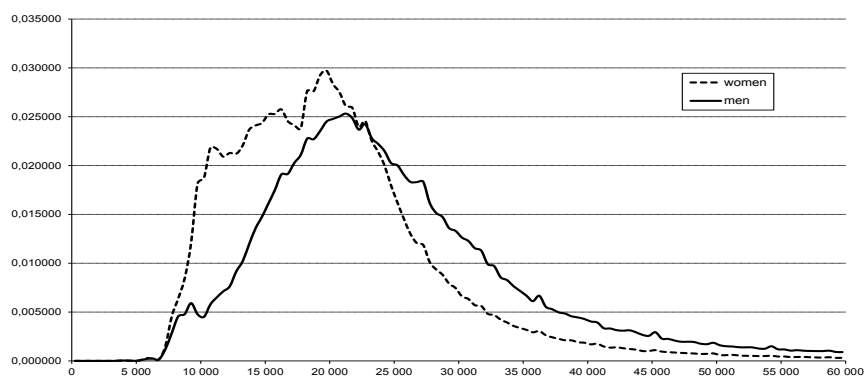

Figure 3: Distribution of relative frequency – men vs. women

Let us, for example, consider average wages of men and women in 2012 and depict the shapes of the empiric densities. The data are shown in Figure 3.

3 JOHNSON MIXTURE

We used the theory from chapter 1. We applied the mixture of Johnson distribution (type S_L , S_B and S_U). The probability density for a general model of a S_B family (and by analogy to others) can be written as follows (where the standard SAS notation is used):

$$PDF('SBMIX', x, n, p, \gamma, \delta, \theta, \sigma) = \sum_{i=1}^n p_i \cdot f_i('SB', x, \gamma_i, \delta_i, \theta_i, \sigma_i) \quad (20)$$

where PDF is a probability density function of a mixture of Johnson distributions (Johnson mix), x is the argument, n is the number of components in the mixture, and p is the vector of weights, for which it holds

$$0 < p_i < 1, \forall i, \sum_{i=1}^n p_i = 1, \quad (21)$$

and $f_i('SB', x, \gamma_i, \delta_i, \theta_i, \sigma_i)$, $i = 1, \dots, n$ are individual Johnson densities in the mixture.

We limited to the situation where $n = 2$ in our example. We worked with two groups (first group are men, second group are women). Then the weights p_i are given as $p_1 = 0.505$, $p_2 = 0.495$.

We remember that p_1 is proportion of men, p_2 is proportion of women. These proportions are very stable in our data set over all time. The probability density function for two groups is given by formula

$$p(x) = \frac{\delta_1}{\sqrt{2\pi}} \cdot \frac{1}{[y/(1-y)]} \cdot \exp\left\{-\frac{1}{2}\left[\gamma_1 + \delta_1 \cdot \ln\left(\frac{y}{1-y}\right)\right]^2\right\} + \frac{\delta_2}{\sqrt{2\pi}} \cdot \frac{1}{[y/(1-y)]} \cdot \exp\left\{-\frac{1}{2}\left[\gamma_2 + \delta_2 \cdot \ln\left(\frac{y}{1-y}\right)\right]^2\right\} \quad (22)$$

It was necessary to estimate the 4 unknown parameters. We utilized the fact that worked with wages. It enabled us to estimate lower and upper bounds as minimum wage (8,500 CZK) and maximum wage (100,000 CZK – only rarely was this amount exceeded). The other two parameters were estimated using percentiles - see above theory and formulas.

The estimated parameters are in Table 2 for group of men for each year. The estimated values of parameters generate time series for years 2003-2012. We used exponential smoothing for forecast of parameters for year 2013.

Table 2 Parameters for group of men

Parameter	γ	δ	θ	σ	2log(Likelihood)
Year	Shape1	Shape2	Location	Scale	LL
2003	15.345	1.540	6,812	217,288,869	13,332,765
2004	16.073	1.636	6,395	205,073,503	16,619,960
2005	16.466	1.648	6,151	263,413,313	18,122,670
2006	16.694	1.679	5,991	268,677,998	19,643,321
2007	17.139	1.746	5,610	269,458,734	20,157,715
2008	18.155	1.862	4,977	288,219,810	20,641,784
2009	17.829	1.856	4,911	260,779,800	19,840,799
2010	18.053	1.890	4,640	259,518,401	20,072,489
2011	18.201	1.899	4,672	272,734,955	20,084,418
2012	18.323	1.928	4,309	261,117,697	20,353,498
2013	19.029	2.001	3,983	284,448,482	20,994,617

The estimated parameters for group of women are in Table 3 for each year. The forecast of parameter for year 2013 is computed by the same way as for group of men.

Table 3 Parameters for group of women

Parameter	γ	δ	θ	σ	2log(Likelihood)
Year	Shape1	Shape2	Location	Scale	LL
2003	5.765	1.362	7,311	478,434	9,620,991
2004	16.677	1.654	6,517	193,218,938	14,775,133
2005	8.296	1.612	6,370	1,504,038	16,384,333
2006	7.933	1.625	6,159	1,248,770	18,501,701
2007	6.034	1.570	6,175	479,875	19,202,361
2008	16.724	1.747	5,571	165,413,602	19,805,367
2009	15.819	1.741	5,602	107,293,147	19,576,666
2010	15.845	1.788	5,477	90,552,060	20,053,535
2011	16.779	1.796	5,325	150,289,341	20,412,698
2012	17.701	1.850	4,937	198,491,692	20,765,533
2013	18.765	1.820	5,266	141,063,777	18,711,336

We built the final *PDF* equation with using parameter values in tables above in the form (the parameters were rounded)

$$\begin{aligned}
 p(x) = & 0.505 \frac{19.03}{\sqrt{2\pi}} \cdot \frac{1}{[y/(1-y)]} \cdot \exp \left\{ -\frac{1}{2} \left[19.03 + 2 \cdot \ln \left(\frac{y}{1-y} \right) \right]^2 \right\} + \\
 & + 0.495 \frac{18.77}{\sqrt{2\pi}} \cdot \frac{1}{[y/(1-y)]} \cdot \exp \left\{ -\frac{1}{2} \left[18.77 + 1.82 \cdot \ln \left(\frac{y}{1-y} \right) \right]^2 \right\}
 \end{aligned}
 \tag{23}$$

When we apply this probability model (with estimated parameters for year 2013) we obtain the forecast of *PDF* with shape

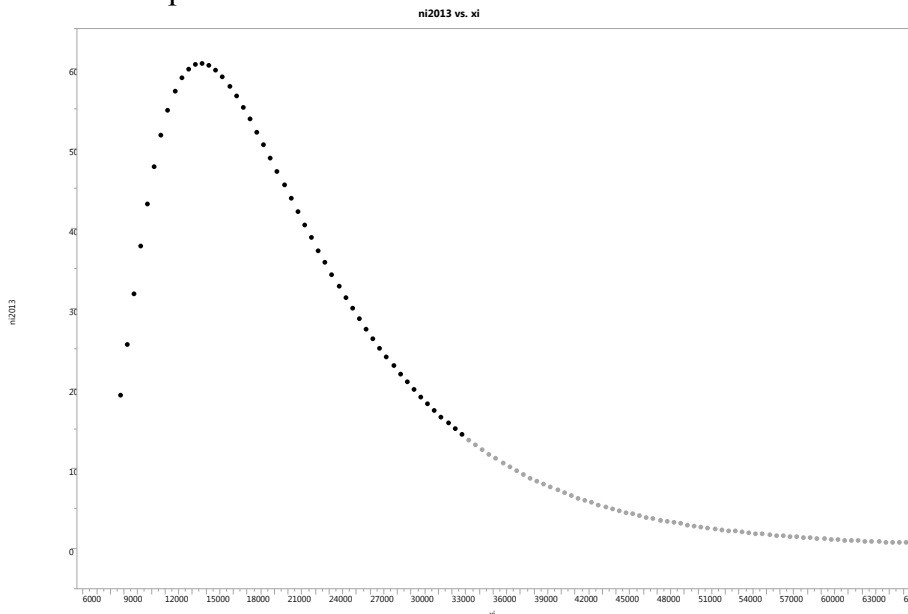

Figure 4: Forecast of probability distribution function for year 2013

The Table 2 contains example (only part of output) the frequency estimations for each wage interval for year 2013. These estimation are calculated from the model of *PDF* on Figure 4.

Table 4 Example of results

X_i	p_{im}	p_{iw}	n_{im}	n_{iw}	n_i
...
9250	0.001663	0.020003	1812.5	23658	25471
9750	0.002466	0.024589	2688.1	29083	31771
10250	0.003439	0.028716	3748.2	33964	37712
10750	0.004561	0.032214	4971.2	38102	43073
11250	0.005804	0.035000	6326.7	41396	47723
11750	0.007137	0.037055	7779.6	43827	51607
12250	0.008525	0.03841	9292.8	45430	54723
12750	0.009935	0.039126	10830	46276	57106
13250	0.011336	0.039279	12357	46457	58814
13750	0.012701	0.038953	13844	46072	59917
14250	0.014004	0.038235	15265	45222	60487
14750	0.015228	0.037201	16600	44000	60600
...

The both tables are computed in MS Excel and in SAS software. The symbols have the following meanings:

- X_i is a middle of the wage interval (when $X_i = 8750$, it means interval 8500 – 9000),
- p_i is approximation of S_B - probability value in each wage interval, in detail:
 - p_{im} is probability that a randomly selected man will have wage in this wage interval,
 - p_{iw} is probability that a randomly selected woman will have wage in this wage interval,
- n_{im} is estimation of absolute frequency value for number of men in this wage interval,
- n_{iw} is estimation of absolute frequency value for number of men in this wage interval,
- n_i is total absolute frequency value in wage interval ($n_i = n_{im} + n_{iw}$).

We note at the end of our analysis that all results and models were tested for adequacy. All achieved results and forecast models were successfully verified and are valid. For adequacy test, we used the common procedures – t-tests, chi-square tests and others.

4 CONCLUSIONS

The analyses were aimed at formulating a model for probability distribution of wages and estimating its future shape. While older data complied with models based on single density curves or on mixture normal or lognormal densities, such an approach has been less successful in the more recent years. The reason for that phenomenon is given by quickly changing parameters of the wage distributions, in particular, their growing variability. Hence we suggested a new approach based on mixtures of Johnson distribution densities. In order to estimate future shape of the probability density, we had to estimate the parameters for the partial densities in our mixture. The results achieved for 2012 were compared with reality; the model's very good quality was thus proven. Moreover, the model underwent a series of verification tests. After that, we arrived at our estimate for 2013. The wage distribution is relatively stable in time and its trend in time is – regardless of the economic crisis – quite predictable. This fact enables us to predict future evolution further ahead than one year. Knowing the future shape of the wage distribution enables us to carry out many analyses and calculations useful in many areas of economics.

Acknowledgements: This work was supported by GACR P402/12/G097.

References

- [1] Bartošová, J. and Bína, V. (2007) 'Mixture Models of Household Income Distribution in the Czech Republic', *16th International Conference APLIMAT 2007 – Conference Proceedings (part I)*, Slovak University of Technology, Bratislava, pp. 307-316, ISBN 978-80-969562-4-1.
- [2] Bílková, D. (2012) 'Lognormal distribution and using L-moment method for estimating its parameters', *International Journal of Mathematical models and methods in Applied Sciences*, vol. 6, 2012, ISSN: 1998-0140
- [3] George, F., Ramachandran, K. M. and Lihua, L. (2009). 'Gene selection with Johnson distribution', *Journal of Statistical Research*, vol. 43, pp. 117-125.
- [4] Hahn, J. G. and Shapiro S. S. (1967). *Statistical models in engineering*, John Wiley & Sons, New York.
- [5] Hill, I. D., Hill, R. and Holder, R. L. (1976) 'Fitting Johnson curves by moments', *Applied Statistics*, vol. 25, pp. 180-189.
- [6] Hosking, J. R. M., Wallis J. R. and Wood E. F. (1985) 'Estimation of the generalized extreme-value distribution by the method of probability-weighted moments' *Technometrics*, vol. 27, pp 251-261.
- [7] Johnson, N. L. (1949). 'Systems of frequency curves generated by methods of translation', *Biometrika*, vol. 36, pp. 149-176.
- [8] Kamziah, A. K., Ahmad, M. I. and Jaffirin, L. (1999) 'Nonlinear regression approach to estimating Johnson SB parameters for diameter data', *Canadian Journal of Forestry Resources*, vol. 29, pp. 310-314.
- [9] Marek, L. (2010) 'Analýza vývoje mezd v ČR v letech 1995-2008', *Politická ekonomie*, 2010, vol. 58, no. 2, pp. 186–206. ISSN 0032-3233.
- [10] Marek, L. and Vrabec, M. (2013) 'Wage Distribution Models', *Recent Advances in Economics and Business Administration, EBA 2013 - International Conference on Economics and Business Administration – Conference Proceedings*, Rhodes Island, pp. 184-188. ISBN 978-1-61804-198-2
- [11] Marek, L. and Vrabec, M. (2010) 'Forecast of the Income Distribution in the Czech Republic in 2011'. *ICABR 2010 – VI. International Conference on Applied Business Research – Conference Proceedings*, Mendel University in Brno, Ras Al Khaimah, pp. 142. ISBN 978-80-7375-462-4.
- [12] Marek, L. and Vrabec, M. (2011) 'The Using of Normal Mixture Distribution for Wages Models', *ICCD A 2011 - IC Computer Desing and Applications – Conference Proceedings*, Mendel University in Brno, Johor Bahru, pp. 159. ISBN 978-80-7375-557-7.
- [13] Slifker, J. and Shapiro, S. (1980) 'The Johnson system: Selection and parameter estimation', *Technometrics*, vol. 22, pp. 239-247.
- [14] Wheeler, R. (1980) 'Quantile Estimators of Johnson curve Parameters', *Biometrika*, vol. 67, pp. 725-728.
- [15] SAS Institute. *Base SAS(R) 9.2 Procedures Guide: Statistical Procedures*, Third Edition.

Author's address

doc. RNDr. Luboš Marek, CSc.

Mgr. Michal Vrabec, CSc.

both authors are from University of Economics, Prague, Faculty of Informatics and Statistics,
Department of Statistics and Probability

nám. W. Churchilla 4, 130 67 Praha

Czech Republic

email: marek@vse.cz , vrabec@vse.cz

CONSISTENCY OF ADDITIVE PREFERENCE MATRIX IN PAIRWISE COMPARISONS

*Markéta Matulová,
Masaryk University, Brno*

Abstract

A lot of methods for solving multiple criteria decision problems requires some weights of criteria. Widely used way of setting weights is based on pairwise comparisons, but there often occur inconsistencies in the preference expression. Saaty defined the consistency ratio for the analytic hierarchy process where the preferences are expressed in a multiplicative way. We propose a measure of inconsistency for additive preference matrix and carry out an empirical comparative study on the degree of inconsistency of the preference relation in both multiplicative and additive form.

Keywords: multicriteria decision making, analytic hierarchy process, pairwise comparisons, consistency

JEL Classification: M10, M20

AMS Classification: 90B50, 91B06

1 INTRODUCTION

One of the crucial steps in most of multicriteria methods is to quantify the criteria relevance. It is often expressed in a relative way by means of weights w_1, \dots, w_n assigned to the n decision criteria by some process of pairwise comparisons. This procedure was originally designed for the analytic hierarchy process (AHP), where it is also used for determining the ranking of the alternatives. Preferences between compared elements (criteria or alternatives) can be expressed in different ways. They are usually arranged in a pairwise comparison matrix (PCM). In this article, there are examined properties of pairwise comparison matrix influencing the possibility to obtain relevant weights from it. The first two parts of the article deal with multiplicative preference information and the way of expressing the degree of its consistency. In the third part, there is suggested consistency index for additive preference matrix. Empirical comparison of the two approaches is given in the final part.

2 MULTIPLICATIVE PREFERENCES

According to widely used Saaty's method [7] the preference information is expressed by intensities from a given scale $\{1/9, 1/8, \dots, 1, \dots, 8, 9\}$, where the value of 1 represents indifference between options and the value of 9 represents absolute preference of one option to the other (and $1/9$ vice versa), other values are intermediate. The intensities are arranged in a pairwise comparison matrix A , where the entries to this matrix a_{ij} are supposed to estimate the ratios $\frac{w_i}{w_j}$ (so the reciprocity condition $a_{ij} = \frac{1}{a_{ji}}$ is required). The expert in charge of assessing should be coherent in expressing his opinion. The elements of fully consistent matrix A fulfill the condition $a_{ij} \cdot a_{jk} = a_{ik}$ for all triplets i, j, k .

Unfortunately, it is almost impossible to be absolutely consistent, especially if there is a lot of compared elements. The degree of consistency can be expressed by some measure of

consistency, overview of the mostly used measures can be found in [3]. We will consider Saaty's consistency index $CI(A)$ defined as

$$CI(A) = \frac{\lambda_{\max}(A) - n}{n - 1}, \quad (1)$$

where $\lambda_{\max}(A)$ is the principal eigenvalue of the matrix A . Despite its name the consistency index expresses the degree of inconsistency. Characterization of the index is given in [8] and some of its properties are described in [4]. It can be proved that the totally consistent matrix A has rank 1 and its only nonzero eigenvalue $\lambda_{\max}(A)$ is equal to n with corresponding eigenvector $w = (w_1, \dots, w_n)$ being the weight vector (then $CI(A) = 0$). If the entries a_{ij} change slightly, the eigenvalues change too. The principal eigenvalue $\lambda_{\max}(A)$ will be slightly greater than n while the others will remain close to zero, so $CI(A)$ is reasonably defined. Some authors [4] estimate the principal eigenvector w by normalization of geometric means of the rows of A and principle eigenvalue by multiplying the sum of the columns of A by the vector w .

In order to eliminate the influence of dimensionality, the consistency ratio $CR(A)$ is introduced by the formula

$$CR(A) = \frac{CI(A)}{RI(n)} \quad (2)$$

where $RI(n)$ is the average value of CI for randomly generated pairwise comparison matrices of the same size n . For determining the value of average consistency index different authors used different simulation methods and their results are more or less close, see Alonso and Lamata's overview [1]. According to Saaty a matrix A should be accepted as sufficiently consistent if its consistency ratio is small enough: $CR(A) < 0.1$. This condition means that the matrix A is among top 10% n -dimensional PCMs in consistency. If the condition is not fulfilled, then a revision of the judgements is recommended.

According to Barzilai [2], characteristics $CI(A)$ and $CR(A)$ are heuristics with poorly understood properties. Moreover he claims that the statement "the closer $\lambda_{\max}(A)$ to n , the more consistent matrix" is not justified anywhere in the AHP literature. But it is not true anymore: although Saaty didn't propose his index $CI(A)$ involving any optimization process, Fedrizzi [5] describes a metric that is minimized by the consistent matrix defined by weights set as the principal eigenvector. The distance of A from the nearest consistent matrix in this metric is exactly $CI(A)$.

3 ALTERNATIVE CONSISTENCY INDEXES

Fedrizzi studies in [5] geometrical characterization of inconsistency evaluation and defines inconsistency index of matrix A generally as its distance from the set of consistent matrices of the same size. He shows that the usage of different metrics leads to different indexes, for example usual Euclidean distance induces the Least Square index LS defined by Chu,

$$LS = \min_{w_1, \dots, w_n} \sum_{i=1}^n \sum_{j=1, j \neq i}^n \left(a_{ij} - \frac{w_i}{w_j} \right)^2, \quad \text{s.t.} \quad \sum_{i=1}^n w_i = 1, w_i > 0 \quad (3)$$

or the logarithmic distance induces the Geometric Consistency Index GCI defined by Crawford and Williams,

$$GCI = \frac{2}{(n-1)(n-2)} \sum_{i=1}^{n-1} \sum_{j=i+1}^n \ln^2 \left(a_{ij} \frac{w_j}{w_i} \right) \quad (4)$$

The logarithmic approach is very promising, because by applying a logarithmic function to all consistent matrices componentwise we get a set of matrices that forms a linear subspace in $R^{n \times n}$. So after the logarithmic transformation, the consistent approximation C of the given matrix A is its orthogonal projection onto this subspace. Barzilai [2] suggests to decompose matrix A to its consistent component C and the error matrix E . This decomposition can be used instead of distorting the answers by forcing the values of judgement to improve consistency.

4 ADDITIVE PREFERENCES

Alternative approach of expressing the preference intensity is using the (nonnegative) additively reciprocal preference matrix B , so that $b_{ij} + b_{ji} = 1$, for every $i, j \in \{1, \dots, n\}$. This approach could be more comfortable to carry out. The instruction for the assessing expert is clearer, assign the values $b_{ij} = b_{ji} = 0.5$ if the elements i, j are equally preferred or assign $b_{ij} = 1$ and $b_{ji} = 0$ if you absolutely prefer i -th option to the j -th one, or you can use something in between: you always divide the unit into two parts according to the preference of the compared elements. One possibility how to set the weights w_1, \dots, w_n is the solution of the system of equations

$$b_{ij} = \frac{w_i}{w_i + w_j}, \quad i, j \in \{1, \dots, n\} \quad (5)$$

The solution exists under the condition, that the matrix B has the multiplicative-transitivity property $b_{ij} \cdot b_{jk} \cdot b_{ki} = b_{ik} \cdot b_{kj} \cdot b_{ji}$ for all triplets of i, j, k [6]. If this condition is violated, there is no solution to the system (5) and the weights have to be approximated.

Let us suppose that B is positive additively reciprocal matrix. Ramík [6] suggests to evaluate the consistency of the matrix B by the additive consistency index $CI_\alpha(B)$ as follows

$$CI_\alpha(B)_{\text{II}} = CI(B^{\text{mod}})$$

where the matrix B^{mod} consists of elements $u(b_{ij})$, $i, j \in \{1, \dots, n\}$ transformed by a function u defined as

$$u(x) = \frac{x}{1-x} \quad (6)$$

The consistency index CI_α defined by (3) can be used for a construction of a rule for accepting matrix as sufficiently consistent. Ramík [6] defined a consistency ratio similarly to the CR introduced in (2). We will modify this idea a bit. Original Saaty's idea of multiplicative consistency ratio was to evaluate consistency of a given matrix A in comparison to a matrix of the same size n , where the preferences were chosen randomly. So we can consider additive preference matrix B in context of randomly constructed additive preference matrices. Let us generate a set of random positive additively reciprocal matrices and compute their consistency indexes. From 500000 runs of such simulation for matrices of size $n \in \{3, \dots, 10\}$ we compute values of average consistency index $RI_\alpha(n)$, and compare them to Alonso and Lamata's [1] values of multiplicative random indexes $RI(n)$ in Table 1. All computations are performed in Matlab.

Table 1: Average additive consistency index $RI_\alpha(n)$ vs. multiplicative index $RI(n)$

n	3	4	5	6	7	8	9	10
RI(n)	0.5245	0.8815	1.1086	1.2479	1.3417	1.4056	1.4499	1.4854
RI α (n)	0.5642	0.9833	1.2899	1.5175	1.693	1.831	1.943	2.032

For a matrix B of size n we propose following definition of additive consistency ratio $CR_{\alpha}(B)$.

$$CR_{\alpha}(B) = \frac{CI_{\alpha}(B)}{RI_{\alpha}(n)}$$

It is recommended to accept matrix B as consistent enough if $CR_{\alpha}(B) < 0.1$.

From the Table 1 we can see that values of additive random indexes $RI_{\alpha}(n)$ are slightly larger those of $RI(n)$. There is an explanation for this fact. Let us suppose that the entries b_{ij} of the upper triangle of the matrix B have the uniform distribution over the interval $[0, 1]$. In the computation of additive consistency index, there is involved matrix B^{mod} whose elements are $u(b_{ij})$ and their range is not restricted. It can be proved that their cumulative distribution function $F(x)$ is the inverse of the transformation function $u(x)$ defined by (6),

$$F(x) = u^{-1}(x) = \frac{x}{x+1}, \quad x \geq 0 \tag{7}$$

For practical computations of the elements of B in the Table 1 we restricted the interval of their distribution to (0.01,0.99) in order to avoid generating "close to zero" elements and subsequent "division by zero" problems in transformation of B . Moreover the restricted scale is used in the multiplicative case too, so the restriction is more suitable for comparison reasons.

5 EMPIRICAL RESULTS

Human ability to express priorities coherently was explored in an empirical study and the results of additive and multiplicative approach were compared. We performed an experiment on setting the criteria for quality evaluation of a supermarket. When determining the importance of different characteristics for the customers satisfaction, we dealt with following nine criteria: 1. range of products, 2. quality and freshness, 3. opening hours, 4. accessibility, 5. parking, 6. clear arrangement, 7. helpful staff, 8. special offers 9. sales promotions.

We carried out an experiment of assessing the above stated criteria by selected customers. They were asked to express their preferences in the multiplicative way (they filled the values of matrix A in a prepared table) and in the additive way (matrix B in another table). They could fill in the tables in an arbitrary order. We calculated the consistency index $CI(A)$ for the multiplicative preference matrix A and the index $CR_{\alpha}(B)$ for the additive preference matrix B . For the calculation of ratios $CR(A)$ and $CR_{\alpha}(B)$ we used the values of average indexes $RI(9) = 1.4499$ and $RI_{\alpha}(9) = 1.943$ from the Table 1. The results are given in the Table 2, the cases of insufficient consistency in one or another way of expressing prioritizations ($CR(A) \geq 0.1$ or $CR_{\alpha}(B) \geq 0.1$) are highlighted.

Table 2: Additive and multiplicative priorities consistency in the supermarket study

	1	2	3	4	5	6	7	8	9	10	11	12
$CI(A)$	0.32	0.12	0.24	0.07	0.54	0.22	0.05	0.2	0.2	0.11	0.22	2.07
$CI_{\alpha}(B)$	0.10	0.11	0.28	0.01	0.32	0.96	0.03	0.23	0.14	0.12	0.15	0.14
$CR(A)$	0.28	0.09	0.17	0.05	0.38	0.15	0.04	0.14	0.14	0.08	0.15	1.43
$CR_{\alpha}(B)$	0.05	0.06	0.14	0.01	0.17	0.49	0.02	0.12	0.07	0.06	0.08	0.07

6 CONCLUSION

As we can see in the Table 2, the results of the two considered approaches are significantly different. The consistence of additive criteria preference matrix B measured by $CR_{\alpha}(B)$ is achieved in more cases than the consistence of multiplicative matrix A (measured by $CR(A)$), the results of additive approach are better in eight out of twelve cases even without the correction by the average indexes $RI(9)$ and $RI_{\alpha}(9)$. It is possible that expressing preferences additively is easier and more natural, but more detailed psychological survey would be necessary to prove this assumption.

However, there are four out of twelve customers, that failed to be sufficiently consistent in both approaches. It is rather large number and it would be probably even larger for more than nine criteria. One of the reasons for the lack of consistency is the restricted range of answers. For a practical application we would recommend either to use a wider range for the preference expression or to replace the comparison matrix by its consistent component C from a decomposition mentioned by Barzilai [2] or some similar decomposition. If the decision maker can confirm that the matrix C is indeed an acceptable reflection of his preferences, no revision of judgements is necessary regardless the level of consistency.

References

- [1] Alonso, J. A. and Lamata, M. T. (2006) 'Consistency in the analytic hierarchy process: a new approach', *International Journal of Uncertainty, Fuzziness and Knowledge-Based Systems*, vol. 18, no. 14, pp. 445 – 459.
- [2] Barzilai, J. (1998) 'Consistency Measures for Pairwise Comparison Matrices', *Journal of Multi-criteria Decision Analysis*, vol. 7, pp. 123 – 132.
- [3] Brunelli, M., Canal, L. and Fedrizzi, M. (2013) 'Inconsistency indices for pairwise comparison matrices: a numerical study', *Annals of Operational Research*, vol. 145, pp. 493-509
- [4] Chen, Q. and Triantaphyllou, E. (2001) 'Estimating Data for Multi-Criteria Decision Making Problems: Optimization Techniques', *Encyclopedia of Optimization*, Boston: Kluwer Academic Publishers, pp. 27-36.
- [5] Fedrizzi, M. (2012) 'Distance-Based Characterization of Inconsistency in Pairwise Comparisons', *Advances in Computational Intelligence*, pp. 30-36.
- [6] Ramík, J. (2012) 'Measuring transitivity of fuzzy pairwise comparison matrix', *Mathematical Methods in Economics 2012 – Conference Proceedings*, The Czech Society for Operations Research Conference, Karviná, pp. 751-756.
- [7] Saaty, T. L. (1980) *The Analytic Hierarchy Process*, New York.
- [8] Saaty, T. L. (2003) 'Decision-making with the AHP: Why is the principal eigenvector necessary', *Journal of operational research*, vol. 145, pp. 85 – 91.

Author's address

Ing. Mgr. Markéta Matulová, PhD.
 Masaryk University, Faculty of Economics and Administration, Department of Applied
 Mathematics and Computer Science,
 Lipová 41a, 602 00 Brno
 Czech Republic
 email: 8987@mail.muni.cz

EFFECTIVE WORKING CAPITAL INVESTMENT - GERMAN FIRMS CASE

*Grzegorz Michalski,
Wroclaw University of Economics*

Abstract

Effectiveness of working capital investments is only one from possible explanations of working capital levels in firms. Too small working capital leads some firms to negative changes in their sale levels. Destruction of cash revenues creation possibilities is dangerous for them and is hard to rebuild possibilities to create cash revenues. Financial liquidity investment efficiency model (FLIEM) predicts that before the crisis, during the crisis and after the crisis phases are connected with higher levels of working capital in processing enterprises. Investments in working capital levels are a hedging instrument against individual risk sensitivity that is higher in crisis affected times. The paper aim is to compare real economy data with FLIEM predictions. The FLIEM model expected that working capital to total assets indicator should be treated as forecasting indicator about future risk sensitivity of the entities. It could be also suitable as forewarning impulse of future standing of whole processing part of economy.

Keywords: *working capital management, entrepreneurial liquidity, business environment, current assets, risk management*

JEL Classification: D92, E44, G00, G01, Q14

AMS Classification: 91G50

1 INTRODUCTION

German economy is believed as driver for economic results in nearest region in which are also V4 countries. For such reason here is used data from manufacturing firms that operate in Germany. Levels of working capital from investment point of view are maintained in entities for hedging purposes against the risk of breaking production fluency and risk of lack final offer for the clients (Bates, Kahle, & Stulz, 2009; Faulkender, & Wang, 2006; Dluhosova, Richtarova, & Culik, 2011). Such kind of investments have also value of option of American type from holding more liquid working capital and value of option of European type from holding less liquid working capital components like inventories and accounts receivables (Michalski 2014; Soltes, & Rusnakova, 2013; Michalski, 2013). There is believed that, both cash and inventory levels should be as small as possible (Ferreira & Vilela, 2004; Kim, Mauer, & Sherman, 1998; Miller & Orr, 1966). How we can point the “as small as possible” level? If financial management decision should be done in context of future cash flows generated by the firm in the risk and uncertainty context, then truth is that the risk is higher, the working capital levels have higher utility (Belas, J., Cipovova, E., Novak, P., & Polach, J., 2012 Polak, 2009; Zmeskal & Dluhosova, 2009; Uzik & Soltes, 2009). There exists very few firms not suffering from that risk, and they do not suffer in the same way always (Opler, Pinkowitz, Stulz, & Williamson, 1999; Pinkowitz & Williamson, 2001; Dluhosova, 2004). Firms sensitivity on risk is different, and it depend on factors connected with its business environment, including before the crisis, during the crisis and after the crisis context (Kulhanek, 2012; Ozkan & Ozkan, 2004; Hudson & Orviska, 2013; Jajuga, 1986). That paper is about Financial Liquidity Investment Efficiency Model (FLIEM) predictions, and empirical data explanation of phenomenon of sensitivity on risk (Dluhosova, 2012; Dittmar & Mahrt-Smith, 2007;). We also try to suggest that working capital to total assets indicator serves as forecasting information and forewarning signal about whole manufacturing part of economy as firm environment (Horvatova, 2008; Kalcheva & Lins, 2007; Zmeskal & Dluhosova, 2010).

Working capital is a result of use active policy in attract the offer to clients by on time and full answer on the purchasers needs (Michalski 2014; Michalski, 2009). Scale of investment in working capital and capital involved in working capital levels is a result of enterprise position in economic environment (Kopa, D'Ecclesia, & Tichy, 2012; Pinkowitz, Stulz, & Williamson, 2006; Gazda, 2002). In effect there are entities that do not hold large levels of working capital. That strong in position firms have small financial vulnerability and lower sensitivity on risk and do not afraid of situation in which risk of too small level of working capital occur (Michalski, 2012d). It is because the cost of too small working capital levels for them is very small or even they have no such opportunity cost or is not linked with negative option value (Soltes, 2010; Glova & Sabol, 2011). But also, there are firms with large financial vulnerability and sensitivity on risk connected to small levels of working capital (Michalski, 2012a). That entities need to keep larger working capital levels to hedge against costly risk of too small working capital levels (Michalski, 2012c). Too small working capital lead that kind of firms to negative changes in their sale levels. Destruction of cash revenues creation possibilities is dangerous for them and is hard to rebuild possibilities to create cash revenues. Free cash flows are generated in context of uncertainty and risk and depend also on working capital management policy of the firm (Michalski 2014; Michalski, 2012b). That risk and uncertainty are mirrored in cost of capital rate that could be used to evaluate current economic value of future free cash flows. The firm keeps larger levels of working capital, and does that, because its managing team has presumption that effect of that action will be firm value building factor. Strategic decision about level of investment in capital tied in working capital levels is made in context of all advantages and all disadvantages.

$$\Delta V = \Delta V_{TZ} + \Delta V_{BZ} = \Delta FF_{0(TZ)} + \frac{\Delta FF_{1.\infty(TZ)}}{C_{(TZ)}} + \Delta FF_{0(BZ)} + \frac{\Delta FF_{1.\infty(BZ)}}{C_{(BZ)}} \quad (1)$$

where: ΔV = enterprise value growth, ΔFF = free cash flows increase or decrease (could be positive when increase or negative when decrease), C = rate of cost of capital financing of the firm, indices: BZ = to small working capital levels consequences, TZ = consequences of holding of working capital levels.

Depending on individual firm situation their individual financial vulnerability and sensitivity on risk, consequences in keeping higher levels of working capital depend on risk sensitivity reported by FLIEM model predictions.

2 MODEL AND DATA

The WC/TA, working capital to total assets in manufacturing firms could serves as forewarning indicator about general economic condition of manufacturing part of real economy. Each firm tries to suit its working capital levels to its business environment. Individual risk sensitivity is a result of entity answer on changes in its internal economic health but also is response on general economic changes. Here we present working capital to total assets indicator in German manufacturing firms. That results are presented in three business environment conditions: 2006 period, named by us as „before the crisis“, 2007-2009 „during the crisis“, and 2010-2012 „after the crisis“. Empirical data confirms our projections derived from theory based on FLIEM model. FLIEM model was presented by Michalski (Michalski 2012a, Michalski 2012b, Michalski 2012c, Michalski 2013). That is useful to describe expected relationship of working capital and total assets (WC/TA) and it depends on firm individual risk sensitivity level. Michalski and Mercik (Michalski & Mercik 2011) and Zietlow and Michalski (Zietlow & Michalski 2012) presented such sensitivity on risk relation on Polish nonprofit organizations. In that paper the relation of risk sensitivity with working capital levels is presented for manufacturing entities. In the context of risk sensitivity, the growth of risk sensitivity is a basis for increase of relation between working capital and total assets (INV/TA). In crisis context, according to FLIEM predictions, that relationship could be treated as an forewarning information of increasing probability of danger of financial difficulties in manufacturing branch. We expected that growing values of working capital levels to total assets (INV/TA) relationship is seen even earlier, before

other economic indicators are a pretty decent. Figure 1 together with table 1 present relationship of average working capital levels to total assets (WC/TA) for data collected from manufacturing firms operating in Germany. Data was collected from manufacturing firms from 1 to 32 sectors that operated incessantly during such 7 years period.

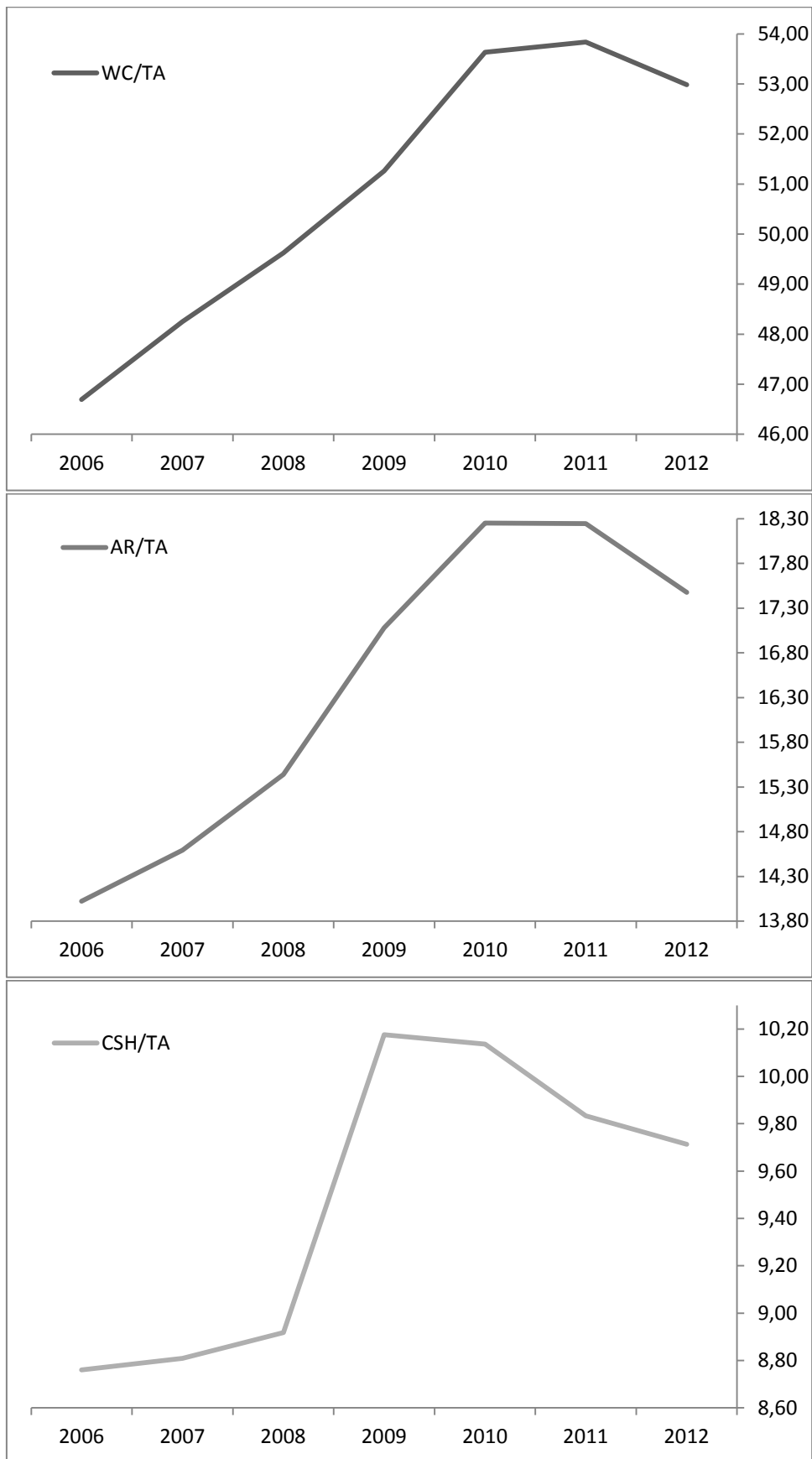

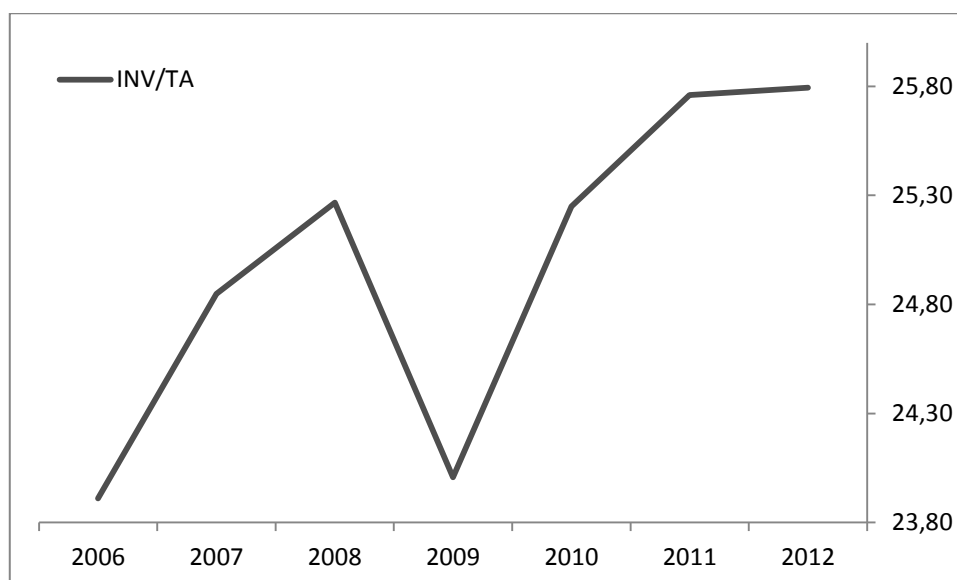

Figure 1 The relationship between working capital and total assets (WC/TA) in manufacturing firms operating in Germany before the crisis (2006), during the crisis (2007-2009) and after the crisis (2010-2012) period. Source: own study based on data from 9004 manufacturing firms operating in Germany reported in Database Amadeus product of Bureau van Dijk, [date: 2014 MAR 15]

Table 1. One year means and standard deviations of (WC/TA) in manufacturing firms operating in Germany before the crisis (2006), during the crisis (2007-2009) and after the crisis (2010-2012) period. Source: own study based on data from 9004 manufacturing firms operating in Germany reported in Database Amadeus product of Bureau van Dijk, [date: 2014 MAR 15]

[%]	2012	2011	2010	2009	2008	2007	2006
WC/TA	52,98	53,84	53,64	51,26	49,63	48,25	46,69
SD (WC/TA)	22,73	22,70	22,94	23,00	22,89	22,89	23,31
CSH/TA	9,71	9,83	10,14	10,18	8,92	8,81	8,76
SD (CSH/TA)	13,37	13,46	13,68	13,88	12,74	12,46	12,70
AR/TA	17,48	18,24	18,25	17,08	15,44	14,59	14,02
SD (AR/TA)	12,86	13,19	13,32	12,97	13,89	14,31	14,77
INV/TA	25,79	25,76	25,25	24,01	25,27	24,85	23,91
SD (INV/TA)	17,11	17,10	16,92	16,52	16,82	16,64	16,47

3 CONCLUSIONS

Presented data from German manufacturing firms is with one accord with FLIEM model predictions. Forecasting of the FLIEM model is useful for make quick judgments about current and future condition of the general population of the manufacturing enterprises, that population risk sensitivity and as global effect of that. There is possible to guess future condition of the whole manufacturing part of economy as well. Next research should be concentrated on future control of overall fit of the FLIEM model and its predictions in after the crisis conditions, cross the countries and cross the sectors research, that could answer how the risk sensitivity characterize the firms from various business branches, and various countries.

Acknowledgements: The presented paper and results is part of monothematic cycle realized as part of grant titled: Efficiency of Investments in Corporate Financial Liquidity. This work was

supported by Polish National Science Centre. The research is financed from the Polish science budget resources in the years 2011–2014 as the research project financed by National Science Centre granted according decision nr DEC-2011/01/B/HS4/04744.

References

- [1] Bates, T., Kahle, K., and Stulz, R. (2009) 'Why do US firms hold so much more cash than they used to?', *The Journal of Finance*, vol. 64, pp. 1985 – 2021.
- [2] Belas, J., Cipovova, E., Novak, P., and Polach, J. (2009) 'Impacts of the Foundation Internal Ratings Based Approach Usage on Financial Performance of Commercial Bank', *E & M Ekonomie a Management*, vol. 15, no. 3, pp. 142-155.
- [3] Dittmar, A., and Mahrt-Smith, J. (2007) 'Corporate governance and the value of cash holdings', *Journal of Financial Economics*, vol. 83, pp. 599–634.
- [4] Dluhosova, D., Richtarova, D., and Culik, M. (2011) 'Multi factor sensitivity analysis in the investment decision-making', *Metal 2011: 20th Anniversary international conference on metallurgy and materials – Conference Proceedings*, pp. 1192-1200.
- [5] Dluhosova, D. (2004) 'An analysis of financial performance using the EVA method', *Finance A Uver- Czech Journal of Economics and Finance*, vol. 54, no. 11-12, pp. 541-559.
- [6] Dluhosova, D. (2012) 'Sensitivity analysis application possibilities in company valuation by two-phase discounted cash flows method', *Managing And Modelling of Financial Risks - 6th International Scientific Conference Proceedings*, vol. 1, pp. 112-119.
- [7] Faulkender, M., and Wang, R. (2006) 'Corporate financial policy and the value of cash', *Journal of Finance*, vol. 61, pp. 1957–1990.
- [8] Ferreira, M., and Vilela, A. (2004) 'Why do firms hold cash? Evidence from EMU countries', *European Financial Management*, vol. 10, pp. 295–319.
- [9] Gazda, V. (2002) 'Estimation of beta coefficients for CAPM using daily time series', *Ekonomicky Casopis*, vol. 50, no. 3, pp. 489-511.
- [10] Glova, J., and Sabol, T. (2011) 'Analysis of bonds with embedded options', *E & M Ekonomie a Management*, vol. 14, no. 3, pp. 77-86.
- [11] Horvatova, E. (2008) 'Capital adequacy conception of banks and investments firms in conditions of European Union', *Ekonomicky Casopis*, vol. 56, no. 6, pp. 582-597.
- [12] Hudson, J., and Orviska, M. (2013) 'Firms' adoption of international standards: One size fits all?', *Journal of Policy Modeling*, vol. 35, no. 2, pp. 289-306.
- [13] Jajuga, K. (1986) 'Bayes classification rule for the general discrete case', *Pattern Recognition*, vol. 19, no. 5, pp. 413–415.
- [14] Kalcheva, I., and Lins, K. (2007) 'International evidence on cash holdings and expected managerial agency problems', *Review of Financial Studies*, vol. 20, pp. 1087–1112.
- [15] Kim, C., Mauer, D., and Sherman, A. (1998) 'The determinants of corporate liquidity: Theory and evidence', *The Journal of Financial and Quantitative Analysis*, vol. 33, pp. 335–359.
- [16] Kopa M., D'Ecclesia R., and Tichy T. (2012) 'Financial Modelling', *Finance a Uver- Czech Journal of Economics and Finance*, vol. 62, no. 2, pp. 104-105.
- [17] Kulhanek, L. (2012) 'The relationship between stock markets and gross domestic product in the Central and Eastern Europe', *The 7th International Conference On Currency, Banking And International Finance - How Does Central And Eastern Europe Cope Up With The Global Financial Crisis? – Conference Proceedings*, Bratislava, pp. 135-145.
- [18] Michalski G., and Mercik A. (2011) 'Liquid assets strategies in Silesian non-profit organizations', *Financial Management of Firms and Financial Institutions*. Ostrava, pp. 258-270.
- [19] Michalski G. (2009) 'Inventory management optimization as part of operational risk management', *Economic Computation and Economic Cybernetics Studies and Research*, vol. 43, no. 4, pp. 213-222.

- [20] Michalski, G. (2012a) 'Risk sensitivity indicator as correction factor for cost of capital rate', *Managing and Modelling of Financial Risks*, Ostrava, pp. 418-428.
- [21] Michalski, G. (2012b) 'Efficiency of accounts receivable management in Polish institutions', *European Financial Systems 2012*, Brno, pp. 148-153.
- [22] Michalski, G. (2012c) 'Financial liquidity management in relation to risk sensitivity: Polish firms case', *Quantitative Methods in Economics: Multiple Criteria Decision Making XVI – Conference Proceedings*, Bratislava, pp. 141-160.
- [23] Michalski, G. (2012d) 'Crisis influence on general economic condition and corporate liquidity management. Financial liquidity investment efficiency model (FLIEM) use to diagnose Polish economics standing', *Proceedings of the 7th International Conference on Currency, Banking and International Finance*, Bratislava, pp. 200-219.
- [24] Michalski, G. (2013) 'Financial consequences linked with investments in current assets: Polish firms case', *European Financial Systems 2013, 10th International Conference on European Financial Systems 2013*, Brno, pp. 213-220.
- [25] Michalski, G. (2014) *Value-Based Working Capital Management. Determining Liquid Asset Levels in Entrepreneurial Environments*, New York: Palgrave Macmillan.
- [26] Miller, M. H., and Orr, D. (1966) 'A model of the demand for money by firms', *Quarterly Journal of Economics*, vol. 80, pp. 413–435.
- [27] Opler, T., Pinkowitz, L., Stulz, R., and Williamson, R. (1999) 'The determinants and implications of corporate cash holdings', *Journal of Financial Economics*, vol. 52, pp. 3–46.
- [28] Ozkan, A., and Ozkan, N.: Corporate cash holdings (2004) 'An empirical investigation of UK companies', *Journal of Banking & Finance*, vol. 28, pp. 2103–2134.
- [29] Pinkowitz, L., and Williamson, R. (2001) 'Bank power and cash holdings: Evidence from Japan', *Review of Financial Studies*, vol. 14, pp. 1059–1082.
- [30] Pinkowitz, L., Stulz, R., and Williamson, R. (2006) 'Contribution of corporate cash holdings and dividends to firm value depend on governance? A cross-country analysis', *The Journal of Finance*, vol. 61, no. 6, pp. 2725-2751.
- [31] Polak P. (2009) 'The centre holds - from the decentralised treasury towards fully centralised cash and treasury management'. *Journal of Corporate Treasury Management*, vol. 3, no. 2, pp. 109-112.
- [32] Soltes, M. (2010) 'Relationship of speed certificates and inverse vertical ratio call back spread option strategy', *E & M Ekonomie a Management*, vol. 13, no. 2, pp. 119-124.
- [33] Soltes, V., and Rusnakova, M. (2013) 'Hedging against a price drop using the inverse vertical ratio put spread strategy formed by barrier options', *Inzinerine Ekonomika-Engineering Economics*, vol. 24, no. 1, pp. 18-27.
- [34] Uzik, M., and Soltes, V. (2009) 'The effect of rating changes on the value of a company listed in the capital market', *E & M Ekonomie a Management*, vol. 12, no. 1, pp. 49–56.
- [35] Zietlow, J., and Michalski, G. (2012) 'Nonprofit Solvency Measures: Polish Evidence', *Unpublished paper presented at the annual meeting of the ARNOVA Annual Conference*, Indianapolis, Unpublished Manuscript.
- [36] Zmeskal, Z., and Dluhosova, D. (2010) 'Financial decisions and valuation of risk and flexibility - a real option', *Managing and Modelling of Financial Risks*, Ostrava, pp. 463-474.
- [37] Zmeskal, Z., and Dluhosova, D. (2009) 'Company financial performance prediction on economic value added measure by simulation methodology', *27th International Conference on Mathematical Methods in Economics, Mathematical Methods in Economics*, pp. 352-358.

Author's address

Mgr. Grzegorz Michalski, PhD.

Wroclaw University of Economics, Faculty of Management, Computer Science and Finance,
Department of Corporate Finance and Value Management

Komandorska 118 / 120, 53-345 Wroclaw, Poland

email: Grzegorz.Michalski@gmail.com

THE ANALYTICAL SYSTEM FOR PORTFOLIO PERFORMANCE AND RISK DISTRIBUTION

Vladimír Mlynarovič,
Comenius University in Bratislava

Abstract

The paper analyses schemes of portfolio performance and risk attribution according its assets classes and the decomposition is compared with the performance of corresponding benchmark assets classes. As a result it provides arithmetic, geometric and exponential performance attributions. The resulting excel application of the methodology is developed and illustrated for pension funds.

Keywords: *portfolio performance and risk decomposition, excel application*

JEL Classification: C44

AMS Classification: 90C15

1 PORTFOLIO PERFORMANCE AND RISK ATTRIBUTION

There are many approaches how to explain or attribute portfolio return, or excess return, and portfolio risk, e.g. Brinson at al. (1986), Karnosky a Singer (1994) Fong at al. (1997) and Clarke et al. (2005). In general, if r_t^P is portfolio return, r_t^B is benchmark return and r_t^E is excess portfolio return in period t , $t = 1, 2, \dots, T$, where

$$r_t^P = \sum_{i=1}^N w_{it}^P r_{it}^P, \quad r_t^B = \sum_{i=1}^N w_{it}^B r_{it}^B \quad \text{a} \quad r_t^E = r_t^P - r_t^B \quad (1.1)$$

and w_{it}^P and w_{it}^B are weights and r_{it}^P a r_{it}^B are returns in sector i for portfolio and benchmark in period t , where N is the number of sectors, then for portfolio return, r_T^P , benchmark return, r_T^B , and excess portfolio return, r_T^E , in period T hold

$$r^P \equiv r_T^P = \prod_{t=1}^T (1 + r_t^P) - 1, \quad r^B \equiv r_T^B = \prod_{t=1}^T (1 + r_t^B) - 1, \quad r^E \equiv r_T^E = \prod_{t=1}^T (1 + r_t^E) - 1 \quad (1.2)$$

Attributions of sectors i , $i = 1, 2, \dots, N$, to returns can express as

$$r_i^P \equiv r_{iT}^P = \sum_{t=1}^T \left[w_{it}^P r_{it}^P \prod_{s=t+1}^T (1 + r_s^P) \right], \quad r_i^B \equiv r_{iT}^B = \sum_{t=1}^T \left[w_{it}^B r_{it}^B \prod_{s=t+1}^T (1 + r_s^B) \right] \quad (1.3a)$$

$$r_i^E \equiv r_{iT}^E = \sum_{t=1}^T \left[(w_{it}^P r_{it}^P - w_{it}^B r_{it}^B) \prod_{s=t+1}^T (1 + r_s^E) \right] \quad (1.3b)$$

while

$$r_T^P = \sum_{i=1}^N r_{iT}^P, \quad r_T^B = \sum_{i=1}^N r_{iT}^B, \quad r_T^E = \sum_{i=1}^N r_{iT}^E \quad (1.4)$$

But risk management and its measurement are important part of portfolio performance analysis as well. It means that important question is an explicit portfolio risk decomposition that measures attributions of individual assets, or asset classes to the portfolio risk.

Interesting approaches to this problem one can find e.g. in *Muromachi* [18] or *P. Grégoire* a *H. van Oppens* [10]. For total portfolio risk we have

$$\delta_P = \sqrt{\frac{1}{T} \sum_{t=1}^T (r_t^P - \bar{r}^P)^2} \quad (1.5)$$

and marginal attribution MC_{it} of sector i to the total portfolio volatility can be expressed as

$$MC_{it}(\sigma_{P_t}) \equiv \frac{\partial \sigma_{P_t}}{\partial w_{it}^P} = \rho(r_{it}^P, r_t^P) \sigma_{it}$$

where $\rho(r_{it}^P, r_t^P)$ is the correlation of asset i returns and portfolio P in period t . The marginal attribution can be used for a decomposition of portfolio volatility in the form

$$\sum_{i=1}^N w_{it}^P MC_{it}(\sigma_{P_t}) = \sigma_P$$

and for each period t the relative contribution C_{it} of sector i is measured as

$$C_{it}(\sigma_{P_t}) = w_{it}^P MC_{it}(\sigma_{P_t})$$

If we define the attribution of sector i to the portfolio return in period t as

$$CR_{it}^P = w_{it}^P r_{it}^P$$

and average attribution that does not depend on the t as

$$\overline{CR}_i^P = \overline{w_i^P r_i^P}$$

then we will have

$$C_{iT}(\sigma_P) = \frac{1}{\sigma_P T} \sum_{t=1}^T (r_t^P - \bar{r}^P) (CR_{it}^P - \overline{CR}_i^P)$$

or

$$C_{iT}(\sigma_P) = \frac{\text{cov}(r^P, w_i^P r_i^P)}{\sigma_P} = \rho(r^P, CR_i^P) \sigma(w_i^P r_i^P) \quad (1.6)$$

and finally

$$\sigma_P = \sum_{i=1}^N C_{iT}(\sigma_P) = \sum_{i=1}^N \rho(r^P, CR_i^P) \sigma(w_i^P r_i^P) \quad (1.7)$$

Equations (1.6) and (1.7) are fundamental for portfolio performance and risk analysis because the sum of contributions equals the total portfolio volatility. The combination of this additive model of volatility contributions with the model of performance attribution (1.3) – (1.4) gives a possibility for portfolio analysis in return – risk space. The similar return one can obtain also for tracking error, or active risk, decomposition.

The presented approach to portfolio analysis was extended in *Brinson a Fachler* (1985), *Carin* (1999), *Mencher* (2001), *Forgy* (2002) and *Hsu et all* (2010), and as a result we have geometrical or exponential approaches to the portfolio performance attribution analysis. Mathematical details of these approaches are over this paper but were implemented in the analytical system that is shortly presented in the following part of the paper

2 EXCEL APPLICATION

The excel application implements and automates characterized methodology by means of excel VBA procedures and macros and is being used for performance and risk analysis of Slovak pension funds

2.1 Basic functions

The application has a database character in the sense that it process daily accounting data that account all pieces of information concerns management and trading of pension fund assets and daily data on assets, or fund returns included in groups of potential benchmarks. Starting from these data databases of individual funds are created with a possibility of their actualization in time and using procedures for archivation , e.g. in the case of analyzed fund changing.

Individual fund asset are recorded according the following 14 asset classes: *Slovak Government Bonds, Sovereign Government Bonds, Banking Bonds, Corporate Bonds, Slovak Money Market, Sovereign Money Market, Municipal Bonds, Current Accounts, M_B(HZL), Shares, Term Deposits, Mutual Funds, Forwards and Others*. On such structuralized database for specified period of analysis one can from a viewpoint of selected assets realized following type of contribution analysis:

- individual asset,
- portfolio of selected assets classes,
- portfolio of selected individual assets.

The performance an risk of selected portfolio is confronted with a benchmark that can be specified in two ways:

- predetermined benchmark according to selected structure of assets classes,
- a benchmark selection by user.

The core of the excel application is the analysis of return development a corresponding cash flows connected with an individual asset in specified time period and following aggregation for specified portfolio according to real assets weights in the portfolio. At the analysis the return of the individual asset is decomposed into following effects:

- effect change of a price change,
- effect of asset buy or sale,
- accrued effect,
- effect exchange change,

and all these effects are take into account in relative level and in level of corresponding cash flows and their influence on net asset value in pension fund as well.

2.2 Illustration results

The application offers as a result whole classes of statistical characteristics for such assets structure that were specified as a performance and risk analysis subject. In this part we present as

an illustration the results of such analysis for one of pension funds for year 2012 in one of possible aggregation level, namely *Equities*, *Bonds*, *Current Accounts* and *Forwards*. The goal is to illustrate main results of the methodology shortly presented and characterized in the previous part of the paper.

Table 1: Arithmetic and exponential contribution of excess return

Excess Return Contributions Effects		Portfolio via Benchmark				
		Equities	Bonds	CA	Forwards	G Portfolio
Arithmetic (Daily Average)	Allocation	-0.001%	0.000%	0.002%	0.000%	0.001%
	- static	0.002%	0.000%	0.002%	0.000%	0.004%
	- dynamic	-0.003%	0.000%	0.000%	0.000%	-0.003%
	Security Selection	-0.001%	0.033%	0.001%	0.000%	0.034%
	Together	-0.001%	0.033%	0.003%	0.000%	0.035%
Average Excess Ret		-0.001%	0.034%	0.002%	0.000%	0.035%
Exponential (Total)	Allocation	-0.186%	-0.068%	0.478%	-0.004%	0.219%
	Security Selection	-0.129%	8.548%	0.217%	-0.006%	8.637%
	Together	-0.315%	8.474%	0.696%	-0.010%	8.875%
	Total Excess Ret					
		Portfolio via Benchmark (% Structure)				
Arithmetic (Daily Average)	Allocation	-2.129%	-0.748%	5.633%	0.000%	2.756%
	- static	5.241%	-0.723%	5.818%	0.000%	10.337%
	- dynamic	-7.370%	-0.026%	-0.185%	0.000%	-7.581%
	Security Selection	-1.448%	96.089%	2.603%	0.000%	97.244%
	Together	-3.577%	95.340%	8.236%	0.000%	100.000%
Average Excess Ret		-3.434%	98.150%	5.284%	0.000%	100.000%
Exponential (Total)	Allocation	-2.095%	-0.768%	0.021%	-0.048%	2.462%
	Security Selection	-1.455%	96.319%	2.446%	-0.062%	97.325%
	Together	-3.547%	95.485%	7.845%	-0.110%	100.000%
	Total Excess Ret					

Table 2: Return and risk contribution

Contributions	Tracking Error				
	Equities	Bonds	CA	Forwards	Total
Return	-0.320%	8.724%	0.474%	0.000%	8.878%
Risk	0.327%	2.878%	0.005%	0.000%	3.211%
Return (% Structure)	-3.602%	98.261%	5.341%	0.000%	100.000%
Risk (% Structure)	10.198%	89.652%	0.150%	0.000%	100.000%
Contributions	Pension Fund				
	Equities	Bonds	CA	Forwards	Total
Return	1.180%	9.860%	0.107%	0.000%	11.147%
Risk	1.826%	2.113%	0.057%	0.000%	3.996%
Return (% Structure)	10.587%	88.451%	0.961%	0.000%	100.000%
Risk (% Structure)	45.687%	52.887%	1.425%	0.000%	100.000%
Contributions	Benchmark				
	Equities	Bonds	CA	Forwards	Total
Return	1.446%	0.999%	-0.358%	0.000%	2.087%
Risk	2.156%	0.066%	0.002%	0.000%	2.224%
Return (% Structure)	69.282%	47.874%	-17.156%	0.000%	100.000%
Risk (% Structure)	96.940%	2.958%	0.102%	0.000%	100.000%

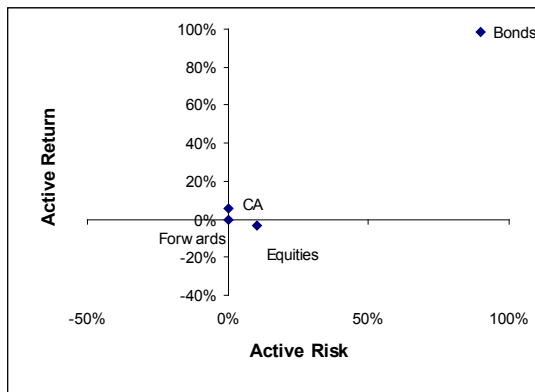

Figure 1: The contribution of active risk and active risk

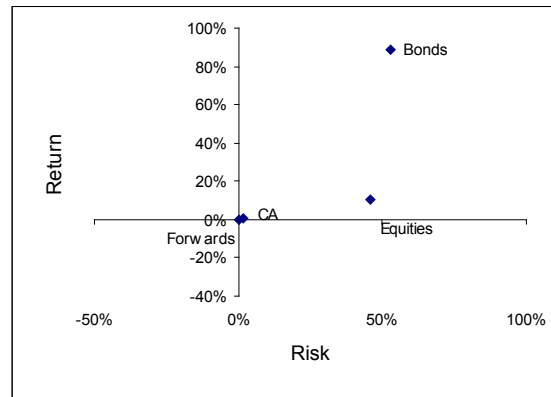

Figure 2: The contribution of fund return and risk

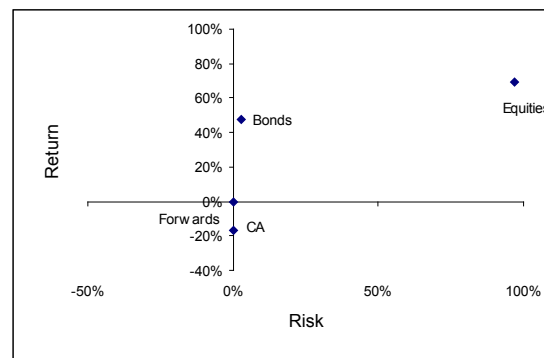

Figure 3: The contribution of benchmark risk and return

References

- [1] Brinson, G.P., Hood, L.R. and Beebower, G.I. (1986) 'Determinants of portfolio Performance', *Financial Analysis Journal*, July-August.
- [2] Brinson, G.P. and Fachler, N. (1985) 'Measuring Non-US Equity Portfolio Performance', *Journal of Portfolio Management*, vol. 11, no. 3, pp. 73-75.
- [3] Carino, D. (1999) 'Combining attribution effects over time', *Journal of Performance Measurement*, Summer, pp. 5-14.
- [4] Clarke, R., De Silva, H. and Thorley, S. (2005) 'Performance Attribution and the Fundamental Law', *Financial Analysis Journal*, vol. 61, no. 5, September-October, pp. 70-83.
- [5] Fama, E. (1972) 'Components of Investment Performance', *Journal of Finance*, vol. 17, no. 3, June, pp. 551-567.
- [6] Fama, E. and French, K. R. (1992) 'The Cross-Section of Expected Stock Returns', *Journal of Finance*, vol. 47, no.2, June, pp. 427-465
- [7] Fama, E. and French, K. R. (1993) 'Common Risk Factors in the Returns on the Stocks and Bonds', *Journal of Financial Economics*, vol. 33, no. 1, February, pp. 3-56
- [8] Fong, C. and Vasicek, O.A. (1997) 'A Multidimensional Framework for Risk Analysis', *Financial Analysis Journal*, vol. 7, no. 8, July-August, pp. 51-57.
- [9] Forgy, E.A. (2002) *Geometric Issue and Sector Selection for Performance Attribution*, [Online], Available: <http://ssrn.com/abstract=1420229>.
- [10] Gregorie, P. and van Oppens, H.: *Risk Attribution*, [Online], Available: <http://www.orfival.be/medias/Gregoire%20and%20van%20Oppens,%20risk%20attribution.pdf>.
- [11] Horniaček, M. (1996) 'The approximation of a strong perfect equilibrium in a discounted supergame', *Journal of Mathematical Economics*, vol. 25, no. 1, pp. 85-107.

- [12] Horniaček, M. (2008) 'Negotiation, preferences over agreements, and the core', *International Journal of Game Theory*, vol. 37, no. 2, pp. 235-249.
- [13] Hsu, J.C., Kolesnik, V. and Myers, B.W. (2010) 'Performance Attribution: Measuring Dynamic Allocation Skill', *Financial Analysis Journal*, vol. 66, no. 6.
- [14] Karnovsky, D.S. and Singer, B.D. (1994) 'Global Asset Management and Performance Attribution', *Research Foundation of the Institute of Chartered Financial Analysts*.
- [15] Menchero, J. C. (2001) 'A Fully Geometric Approach to Performance Attribution', *Journal of Performance Measurement*, vol. 5, no. 2, pp. 36-42.
- [16] Menchero, J. C. (2004) 'Multiperiod Arithmetic Attribution', *Financial Analysis Journal*, vol. 60, no. 4, pp. 76-91.
- [17] Mlynarovič, V. (2001) *Finančné investovanie*, Bratislava: IURA Edition.
- [18] Muromachi, Y. *Decomposing total risk of a portfolio into the contributions of individual assets*, [Online], Available:
www.actuaries.org/ASTIN/Colloquia/Helsinki/Papers/S5_19_Muromachi.pdf.

The author:

doc. Ing. Vladimír Mlynarovič, CSc.
Univerzita Komenského v Bratislave, FSEV
Mlynské luhy 4, Bratislava
email: vladimir.mlynarovic@fses.uniba.sk

EFFICIENCY OF THE MATCHING PROCESS ON THE CZECH REGIONAL LABOUR MARKETS

*Daniel Němec,
Masaryk University, Brno*

Abstract

This contribution aims to quantify the performance of the Czech regional labour markets and to reveal the most influencing economic factors standing behind. Investigated labour markets are described by the corresponding matching functions. From this point of view the successful matches are treated as an output of production process where unemployed are paired with vacancies. Resulting unemployment outflows are determined by the efficiency of this matching process. Using stochastic frontier model approach, we estimate the efficiency of regional matching functions, evaluate the differences among the regions and reveal the key determinants of this kind of effectiveness. The stochastic frontier is estimated using regional panel data for the period 1997-2013.

Keywords: *matching efficiency, matching function, regional labour markets, stochastic frontier model, panel data, Czech Republic*

JEL Classification: R23, J41, C23, E24

AMS Classification: 62P20

1 INTRODUCTION

Labour market efficiency belongs to the most important factors influencing labour market dynamics and its performance. There are many approaches how to deal with the “efficiency” concept. Most of them are based on the matching function framework which expresses the connection of successful labour market matches as an outcome of interactions between unemployed job seeker and vacancies. This contribution aims to quantify the effectiveness of the Czech labour market from the view of regional labour markets using the stochastic frontier panel data model approach with monthly regional data and explicitly treated fixed effects term in the matching function model equation. On the one hand, this approach extends the previous investigations of the efficiency of the Czech labour market carried out by Němec [5], [6] or by Tvrdou and Verner [7]. Their results have been based on the aggregate labour market statistics. On the other hand, using the data from monthly regional labour market statistics and stochastic frontier panel data model methodology, it offers a new insight into the outcomes of the Czech labour market in the last 15 years and extends the detailed analysis of Galuščák and Münich [2] in a specific way, dealing with efficiency issues.

Stochastic frontier model approach has been used by Ilmakunnas and Pesola [4] in their study of regional labour markets in Finland. They used annual data and did not take into account explicitly possible individual fixed effects of examined regions. Gorter et al. [3] investigated the efficiency in the Dutch labour market in Netherland along the same lines. They have observed that the estimated labour market efficiency increases during the recession and recovery period while it decreases during the economic booms. This interesting feature is considered in this contribution as well.

2 STOCHASTIC FRONTIER MODEL WITH PANEL DATA

Stochastic frontier model approach allows us to measure the performance of production units which use inputs to produce outputs of any kind. Production technology is described by the production function. This parametric approach to measure technical inefficiency may be used in

many applications. As for the labour market framework, the production technology of a labour market is usually described by the matching function.

2.1 Matching function and matching efficiency

The matching function expresses the interaction mechanism between the unemployed and vacancies. This concept is based on the fact that both the flows of unemployed and the flows of unfilled job vacancies are able to meet each other. This dynamic relationship could be described simply by a standard production function with two inputs: the unemployed and the vacancies. New matches are thus an outcome of this matching process. In my contribution, the regional labour markets are represented by a standard Cobb-Douglas matching function in log-linear form:

$$\ln M_{it} = \alpha_i + \beta_u \ln U_{it} + \beta_v \ln V_{it} + \varepsilon_{it}, \quad (1)$$

where $i=1, \dots, N$ denotes the regions and $t=1, \dots, T$ the time periods. The α_i terms are fixed regional effects and ε_{it} represents stochastic factors. This basic form of matching function may be extended and modified in many ways. Ilmakunnas and Pesola [4] implemented regional and labour force characteristics directly into the matching function by means of other explanatory variables. Resulting efficiency was thus a linear function of regional fixed effects and various regional characteristics. In their view, the term ε_{it} was treated purely as white noise process. Similar approach may be found in the work of Gorter et al. [3]. Galuščák and München [2] enhanced the basic matching function form by the flow factors (i.e. unemployment and vacancy inflows realized during the time period). Stochastic frontier model approach tries to model the stochastic term ε_{it} as consisting of combination of random variations in the matching process and the region specific inefficiency term. Regional and labour force characteristics are then implemented directly into this inefficiency term. This approach was used by Ilmakunnas and Pesola [4]. But they did not include the fixed (or random) region effects. In my contribution, I try to estimate the inefficiency of the Czech regional labour market using fixed effect panel stochastic model. This model approach is thus able to capture region specific individual effects, basic matching function characteristics and time-varying regional inefficiency terms at once.

2.2 Fixed effect panel stochastic model

To estimate matching function parameters and the inefficiency of the matching process we use the approach proposed by Wang and Ho [8]. Their specification of a stochastic frontier model is as follows:

$$y_{it} = \alpha_i + \mathbf{x}_{it}\boldsymbol{\beta} + \varepsilon_{it}, \quad (2)$$

$$\varepsilon_{it} = v_{it} - u_{it}, \quad (3)$$

$$v_{it} \sim N(0, \sigma_v^2), \quad (4)$$

$$u_{it} = h_{it} \cdot u_i^*, \quad (5)$$

$$h_{it} = f(\mathbf{z}_{it}\boldsymbol{\delta}), \quad (6)$$

$$u_i^* \sim N^+(\mu, \sigma_u^2), \quad i=1, \dots, N \quad t=1, \dots, T. \quad (7)$$

In this model framework, α_i is individual fixed effect for the unit i , \mathbf{x}_{it} is a $1 \times K$ vector of explanatory variables, v_{it} is a random error with zero mean, u_{it} is a stochastic variable measuring inefficiency, and h_{it} is a positive function of a $1 \times L$ vector of non-stochastic determinants of inefficiency (\mathbf{z}_{it}). Constant term is excluded from explanatory variables and inefficiency determinants. It should be clear that the notation N^+ means that the realized values of the variable u_i^* are positive. In case of $\mu = 0$ the variable u_i^* follows a half-normal distribution.

Wang and Ho [8] showed how to remove the fixed individual effect from the model. This procedure allows us to estimate all the model parameters. Of course, the individual effects may be recovered from the final parameter estimates. There are two possible approaches to model transformation: first-differencing and within-transformation. Both methods are equivalent (see Wang and Ho [8]). Stochastic frontier model of the Czech regional labour markets has been identified using the first-difference transformation. The main points of this methodology may be described as follows (for detailed discussion see Wang and Ho [8]).

It is necessary to define first difference of corresponding variables as $\Delta w_{it} = w_{it} - w_{it-1}$ and the stacked vector of Δw_{it} for a given i and $t = 2, \dots, T$ is denoted as $\Delta \tilde{w}_i = (\Delta w_{i2}, \Delta w_{i3}, \dots, \Delta w_{iT})'$. Assuming that the function h_{it} is not constant, i.e. the vector z_{it} contains at least one time-varying variable, the model in its first-difference form may be expressed as:

$$\Delta \tilde{y}_i = \alpha_i + \Delta \tilde{x}_i \beta + \Delta \tilde{\varepsilon}_i, \quad (8)$$

$$\Delta \tilde{\varepsilon}_i = \Delta \tilde{v}_i - \Delta \tilde{u}_i, \quad (9)$$

$$\Delta \tilde{v}_i \sim MN(0, \Sigma), \quad (10)$$

$$\Delta \tilde{u}_i = \Delta \tilde{h}_i u_i^*, \quad (11)$$

$$u_i^* \sim N^+(\mu, \sigma_u^2), \quad i = 1, \dots, N \quad (12)$$

It is obvious from panel data models that first-difference introduces correlations of Δv_{it} within the i th panel. The covariance matrix of the multivariate distribution of $\Delta \tilde{v}_i$ is

$$\Sigma = \begin{bmatrix} 2\sigma_v^2 & -\sigma_v^2 & 0 & \dots & 0 \\ -\sigma_v^2 & 2\sigma_v^2 & -\sigma_v^2 & \dots & \vdots \\ 0 & \ddots & \ddots & \ddots & \vdots \\ \vdots & \ddots & \ddots & \ddots & -\sigma_v^2 \\ 0 & 0 & \dots & -\sigma_v^2 & 2\sigma_v^2 \end{bmatrix}. \quad (13)$$

The covariance matrix Σ has elements $2\sigma_v^2$ on the diagonal and $-\sigma_v^2$ on the off-diagonal. The key point revealed by Wang and Ho [8] is that the distribution of the term u_i^* is unaffected by the transformation. This fact helps to derive marginal log-likelihood function for each panel unit:

$$\ln L_i = -\frac{1}{2}(T-1)\ln(2\pi) - \frac{1}{2}(T-1)\ln(\sigma_v^2) - \frac{1}{2}\Delta \tilde{\varepsilon}_i' \Sigma^{-1} \Delta \tilde{\varepsilon}_i + \frac{1}{2}\left(\frac{\mu_*^2}{\sigma_*^2} - \frac{\mu^2}{\sigma_u^2}\right) + \ln\left(\sigma_* \Phi\left(\frac{\mu_*}{\sigma_*}\right)\right) - \ln\left(\sigma_u \Phi\left(\frac{\mu}{\sigma_u}\right)\right) \quad (14)$$

where

$$\mu_* = \frac{\mu / \sigma_u^2 - \Delta \tilde{\varepsilon}_i' \Sigma^{-1} \Delta \tilde{h}_i}{\Delta \tilde{h}_i' \Sigma^{-1} \Delta \tilde{h}_i + 1 / \sigma_u^2} \quad \sigma_*^2 = \frac{1}{\Delta \tilde{h}_i' \Sigma^{-1} \Delta \tilde{h}_i + 1 / \sigma_u^2} \quad \Delta \tilde{\varepsilon}_i = \Delta \tilde{v}_i - \Delta \tilde{x}_i \beta. \quad (15)$$

In this expression, Φ is the cumulative density function of a standard normal distribution. Log-likelihood function of the model is obtained by summing the above function over all panel units.

Wang and Ho [8] approximated the observation specific technical inefficiency as conditional expectation

$$E(u_{it} | \Delta \tilde{\varepsilon}_i) = h_{it} \left[\mu_* + \frac{\phi(\mu_* / \sigma_*) \sigma_*}{\Phi(\mu_* / \sigma_*)} \right] \quad (15)$$

evaluated at estimated values of term $\Delta \tilde{\varepsilon}_i$. This is a modified estimator of inefficiency terms which uses $\Delta \tilde{\varepsilon}_i$ instead of $\tilde{\varepsilon}_i$ as the conditional term. The main advantage is that the vector $\Delta \tilde{\varepsilon}_i$ contains all the information of individual unit in the sample and does not depend on individual effect term α_i that has the variance of higher order in case of small time dimension of the sample

(variance of order $1/T$ in comparison to the variance of $1/((N-1)T)$ for the estimator $\hat{\beta}$). Technical efficiency may be obtained in accordance with other studies (see Battese and Coelli [1]) as $\exp(-u_{it})$. For derivation of individual fixed effects terms see Wang and Ho [8].

2.3 Data and model specification

The model for the Czech regional labour markets is estimated using the monthly data set covering a sample of 77 districts from the January 1997 to the June 2013. In comparison with the other authors I try to use this “high” frequency data set due to fact that the aggregation may lead to some losses of information. Galuščák and München [2] worked with quarterly data, Ilmakunnas and Pesola [4] and Gorter et al. [3] focused on annual data of regions in Finland and Netherland respectively.

The original data come from database of the Ministry of Labour Social Affairs which cover the data from regional Employment offices. I used the following variables: the number of registered successful matches, M_{it} , in the corresponding month, the number of unemployed at the start of the month, U_{it} , and the number of vacancies at the start of the month, V_{it} . All the data are seasonally unadjusted because we treat the seasonal patterns of the labour market characteristics within the factors influencing the inefficiency term.

Panel data set consists of 77 districts and 198 monthly periods. In accordance with Galuščák and München [2], three districts were omitted: Praha, Praha-Východ and Praha-Západ. These labour markets are too specific in their labour market dynamics. The estimated model has the form defined by the equations (2)-(7), where $y_{it} = \ln M_{it}$, $\mathbf{x}_{it} = (\ln U_{it}, \ln V_{it})$, $\boldsymbol{\beta} = (\beta_u, \beta_v)'$, $h_{it} = \left| \delta_{time}t + \delta_{time^2}t^2 + \delta_{Q2}Q2 + \delta_{Q3}Q3 + \delta_{Q4}Q4 \right|$, where t represents the time trend and $Q2$, $Q3$ and $Q4$ are seasonal quarterly dummies for the 2nd, 3rd and 4th quarters respectively. I have defined $\mu = 0$ and we have thus a half-normal representation of the model. There is no possibility to obtain district specific labour market characteristic due to monthly data frequency. Inefficiency terms capture time trend (which is usual in many applications, see e.g. Battese and Coelli [1]) and seasonal factors which may be thus connected directly with the efficiency of the labour markets. For computational purposes, the variance parameters were parameterised as $c_v = \ln \sigma_v^2$ and $c_u = \ln \sigma_u^2$ respectively.

3 EFFICIENCY ESTIMATES

The model parameters were estimated by numerically maximizing the sum of marginal log-likelihood functions (13). All the estimation procedures were performed using Matlab version 2013b and its implemented function for unconstrained maximization. I have estimated two model specifications. The first model was estimated using the full sample of the period 1998 to 2013. To reveal the possible changes in the model parameters and to capture the time variations of inefficiency in more detail, the yearly rolling estimates were carried out. Separate model were thus estimated for the years 1998-2012. In this case, the quadratic term in the inefficiency scaling factor h_{it} was omitted.

Table 1: Parameter estimates (full sample 1997-2013)

$\beta_{\log(u)}$	$\beta_{\log(v)}$	δ_{time}	δ_{time^2}	δ_{Q2}	δ_{Q3}	δ_{Q4}	$\log \sigma_v^2$	$\log \sigma_u^2$
0.7131	0.0896	0.2843	0.0652	-0.2708	0.1102	0.3794	-2.6163	-1.1772

Table 1 presents the estimated parameters for the model covering the whole sample period. Estimated coefficients $\beta_{\log(u)}$ and $\beta_{\log(v)}$ does not confirm the empirical findings that with regional data it may be more likely to find increasing returns in matching (see Ilmakunnas and

Pesola [4]). But, as it will be seen later, this conclusion may be an outcome of strong assumption that these parameters remain stable through the whole period. On the other hand, the tendencies provided by the estimates of parameters in the efficiency scale factor h_{it} are evident. Regarding the parameters on the time trend variables we can see the rising inefficiency patterns in the regional matching processes. This negative development is typically reverted in the second quarter of each year. Higher variability, σ_u^2 , of the inefficiency term in comparison to the white noise process variability, σ_v^2 , contributes to the satisfying identification of the stochastic frontier model (as stated by Wang and Ho [8]).

Figure 1 shows the interquartile range of inefficiency terms distributions for all 74 districts using the estimates on full sample period. The number corresponds with the sorting order of districts in the source data files provided by Ministry of Labour and Social Affairs (after excluding the Prague regions).

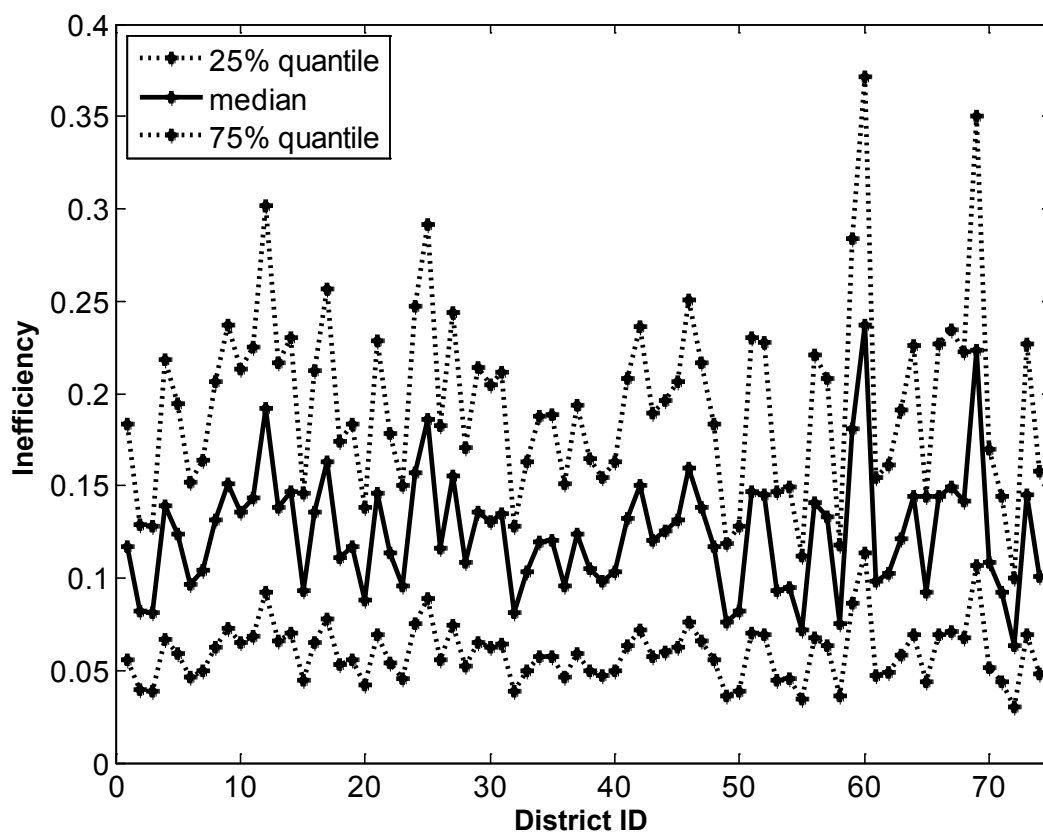

Figure 1: Inefficiency range (full sample 1997-2013)

Minimum inefficiency values for each district (which are not presented here) are almost zero for all investigated labour markets. It is this clear that all the regions are able to match the unemployed with the vacancies at the full rate. It is caused mostly by the seasonal factors in the second quarter of the year. Figure 1 suggests that there are some regions with exceptionally good or bad efficiency performance.

A detailed view on the inefficiency patterns in selected districts may be found in the Table 2. It may be surprising that one of the best performing districts is the district Most or Nový Jičín. These districts do not belong to the regions with the low unemployment properties. But, it should be stressed that low inefficiency does not automatically means low unemployment. It expresses the potential for new created matches which can be constituted by the interaction between unemployed and available vacancies.

Table 2: Selected district inefficiency patterns (full sample 1997-2013)

ID	District	Minimum	25% quantile	50% quantile	75% quantile	Maximum
2	Beroun	0.0006	0.0393	0.0821	0.1288	0.2274
32	Most	0.0006	0.0390	0.0816	0.1280	0.2260
72	Nový Jičín	0.0004	0.0304	0.0636	0.0997	0.1761
25	Cheb	0.0013	0.0889	0.1858	0.2915	0.5146
60	Jeseník	0.0016	0.1132	0.2367	0.3713	0.6556
69	Bruntál	0.0015	0.1068	0.2231	0.3501	0.6181

From this point of view, these results imply that the potential of labour market is utilized quite well. There may be an appropriate structure of unemployed and vacancies, unobserved characteristics of the unemployed support their willingness to active job search and finally, the surrounding regions may offer other possibilities for employing unemployed job applicants (this spatial dependency is not implemented in estimated models so far). The unfavourable efficiency outcomes of the districts Jeseník or Bruntál may be thus explained in a similar way.

Table 3: Parameter estimates (rolling windows 1998-2012)

	$\beta_{\log(u)}$	$\beta_{\log(v)}$	δ_{time}	δ_{Q2}	δ_{Q3}	δ_{Q4}	$\log \sigma_v^2$	$\log \sigma_u^2$
1998	1.3574	0.2712	0.0960	-0.3840	-0.3393	-0.2636	-2.8048	-1.1863
1999	1.7943	0.0542	-0.1082	0.4329	0.5805	0.6225	-3.0978	-1.2216
2000	1.5210	0.1923	-0.0584	0.2336	0.3001	0.3031	-3.0569	-1.2847
2001	1.8825	0.4025	0.1182	-0.4728	-0.5923	-0.6603	-3.0326	-1.1917
2002	0.5865	0.2363	0.0489	-0.1958	0.0204	0.0687	-2.8258	-1.2155
2003	0.6480	0.1730	0.0419	-0.1678	-0.0533	0.0364	-3.0108	-1.2502
2004	2.4917	0.1851	0.1133	-0.4723	-0.7019	-0.7737	-3.0411	-1.1916
2005	0.6432	0.1400	0.0540	-0.2161	0.0076	0.0256	-2.7998	-1.2485
2006	1.8826	0.3914	0.1608	-0.6820	-0.8764	-1.2779	-2.868	-1.0939
2007	0.6849	0.3607	0.0566	-0.2263	0.1060	0.0012	-2.6297	-1.2139
2008	0.6581	0.5464	0.0481	-0.1923	0.1161	-0.0104	-2.7926	-1.2154
2009	2.1295	0.1837	0.1054	-0.4215	-0.4260	-0.3535	-2.9602	-1.3281
2010	0.5669	0.4198	0.0700	-0.2799	0.0156	0.1354	-2.4649	-1.2040
2011	1.1749	0.3948	0.1437	-0.5749	-0.6936	-0.7646	-2.7806	-1.1537
2012	0.8342	-0.0053	0.1811	-0.7245	-0.6525	-0.4728	-2.6561	-0.9824

Table 3 shows the changes in point estimates of model parameters based on the estimates using the yearly rolling window. In this case, there are years with high match elasticity to unemployed. This feature leads naturally to the increasing returns to scale which is in accordance with prevailing literature dealing with regional labour market data. The negative elasticity of matching outcomes to the vacancies should be treated as zero. T is a sign of worsening labour market conditions in the Czech economy. Due to shorter time span, only the linear trend variable has been used in the inefficiency scaling parameter h_{it} .

The inefficiency within the year tends to be rising and accompanied by important seasonal patterns, especially by positive effect on the matching function outcomes in the second quarters. Results from the Table 3 highlight the needs to incorporate possible parameter changes into the modelling procedures. Another explanation of the parameter instability may be the lack of regional specific inefficiency variables varying across the time and cross-sections. That remains as an important task for further model enhancements.

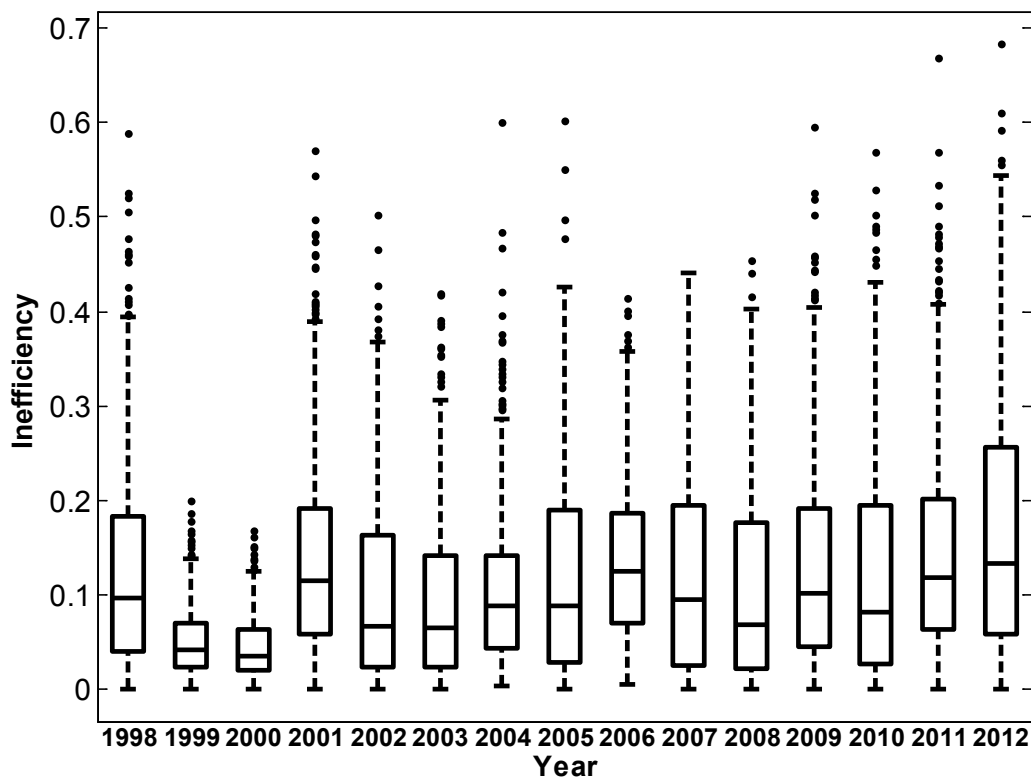

Figure 2: Inefficiency distributions (rolling windows estimates 1998-2012)

Figure 2 depicts the distribution of inefficiency terms across the Czech districts during the period from 1998 to 2012. This figure summarises the aggregate regional inefficiency changes in a straightforward way. We can observe the periods of 1999 and 2000 performing low differences in the efficiency of the regional labour markets. It is the period after the economic crisis of 1997. These years may be described by rising unemployment rates in all regions. But, it seems that the rise of unemployment was accompanied in general by the effective vacancy posting.

The differences across the regions started to be diminishing in the period from 2001 to 2004. After 2005 the variability in inefficiency properties of the regional labour markets tends to be rising again. We may observe the biggest diversity in the 2012. These results do not indicate that the estimated labour market inefficiency may rise during the recession and recovery period while it decreases during the economic booms. Regarding the fact that Gorter et al. [3] used annual data, it should be noted that this contradiction is not conclusive.

4 CONCLUSION

In my contribution, I have presented an alternative approach to measure the efficiency of the matching process on the Czech regional labour markets. Obtained results shows, that the stochastic frontier model approach is able to capture some interesting patterns of these labour markets controlling individual fixed effects of examined districts and possible time-varying changes in the inefficiency terms. The model estimates using the full sample displays rising tendency of matching inefficiency in all districts with strong seasonal patterns. These tendencies are accompanied by rising disparities among the regions although the low inefficiency does not necessary mean the low unemployment in the investigated districts.

It will be of great importance in further research to focus on the model outcomes using the aggregate quarterly and yearly data that allows including region specific variables. Moreover, the spatial properties of the labour markets dynamics should be investigated, i.e. the efficiency terms should incorporate the influence of neighbouring districts.

Acknowledgements: This work is supported by funding of specific research at Faculty of Economics and Administration, project MUNI/A/0808/2013.

References

- [1] Battese, G. E., and Coelli, T. J. (1995) 'A Model for Technical Inefficiency Effects in a Stochastic Frontier Production Function for Panel Data', *Empirical Economics*, vol. 20, pp. 325–332.
- [2] Galuščák, K., and Münich, D. (2007) 'Structural and Cyclical Unemployment: What Can Be derived from the Matching Function', *Czech Journal of Economics and Finance*, vol. 57, pp. 102–125.
- [3] Gorter, C., Nijkamp, P., and Pels, E. (1997) 'Vacancy Dynamics and Labor Market Efficiency in the Dutch Labor Market', *Growth and Change*, vol. 28, pp. 173–200.
- [4] Ilmakunnas, P., and Pesola, H. (2003) 'Regional Labour Market Matching Functions and Efficiency Analysis', *Labour*, vol. 17, pp. 413–437.
- [5] Němec, D. (2013) 'Evaluating labour market flexibility in V4 countries', *Proceedings of Mathematical Methods in Economics 2013 – Conference Proceedings*, The Czech Society for Operations Research Conference, Jihlava, pp. 661–666.
- [6] Němec, D. (2013) 'Investigating Differences between the Czech and Slovak Labour Market Using a Small DSGE Model with Search and Matching Frictions', *The Czech Economic Review*, vol. 7, pp. 21–41.
- [7] Tvrdoň, M., and Verner, T. (2012) 'Regional unemployment disparities and their dynamics: Evidence from the Czech Republic', *Mathematical Methods in Economics 2012 – Conference Proceedings*, The Czech Society for Operations Research Conference, Karviná, pp. 938–943.
- [8] Wang, H., and Ho, C. (2010) 'Estimating fixed-effect panel stochastic frontier models by transformation', *Journal of Econometrics*, vol. 157, pp. 286–296.

Author's address

Ing. Daniel Němec, PhD.

Masaryk University, Faculty of Economics and Administration, Department of Economics

Lipová 41a, 602 00 Brno

Czech Republic

email: nemecd@econ.muni.cz

ARIMA WITH INTERVENTION ANALYSIS TO MODEL AND FORECAST EXPORT OF GOODS AND SERVICES OF SLOVAK REPUBLIC

*Silvia Pastoreková,
VŠB – Technical University of Ostrava*

Abstract

Nowadays, there are a lot of methods and techniques to analyze and forecast time series. One of the most used is methodology based on autoregressive integrated moving average (ARIMA) model by Box and Jenkins. However, in some cases when the trend of time series is disturbed by unexpected external shocks using of this model does not have to provide the accurate and valid results and estimations.

In this paper we attempt to model and analyze the impact of financial and global economic crisis on the export of goods and services of Slovakia. The aim of the research paper is to demonstrate the usefulness of ARIMA Intervention time series analysis as both an analytical and forecast tool. Intervention analysis is an extension of the ARIMA models to measure the effect of a policy change or external event on the outcome of a variable.

Keywords: *ARIMA model, Intervention analysis, transfer function, forecast, export of goods and services of Slovak Republic*

JEL Classification: C44

AMS Classification: 90C15

1 INTRODUCTION

Slovakia, an export-driven economy has likewise been affected by global economic slowdown, resulting in weaker domestic demand and decreasing export. We can observe this phenomenon in almost all macroeconomic indicators in the end of 2008. Using ARIMA for modeling of time series affected by global economic crisis we might not fit accurately its development. For this purpose we will therefore attempt to use ARIMA intervention analysis and assume that this methodology is more precise at explaining and analyzing the intervention effects.

1.1 ARIMA model

The ARIMA model methodology was first introduced by Box and Jenkins in 1976 [1], and ARIMA models are often referred to as Box-Jenkins models. This approach analyzes univariate stochastic time series, i. e. error term of this time series. For this to be possible, the analyzed time series must be stationary. This means that the mean, variance and covariance of the series are all constant over time. However, most economic and financial time series show trends over time. To achieve the stationarity we take differencing and/or logarithms.

ARIMA model (with seasonal terms) can be written as follows:

$$y_t = \phi_1 y_{t-1} + \phi_2 y_{t-2} + \dots + \phi_p y_{t-p} + \Phi_1 y_{t-s} + \Phi_2 y_{t-2s} + \dots + \Phi_P y_{t-Ps} + a_t - \theta_1 a_{t-1} - \theta_2 a_{t-2} - \dots - \theta_q a_{t-q} - \Theta_1 a_{t-s} - \Theta_2 a_{t-2s} - \dots - \Theta_Q a_{t-Qs} \quad (1.1)$$

Using backshift (lag) operator we can rewrite (1):

$$\phi_p(B)\Phi_P(B^s)z_t = \theta_q(B)\Theta_Q(B^s)a_t \quad (1.2)$$

where:

$$z_t = (1-B)^d(1-B^s)^D \ln(y_t)$$

$\phi_p(B)$ – nonseasonal operator of autoregressive process AR(p)

$\theta_q(B)$ – nonseasonal operator of moving average MA(q)

$\Phi_P(B^s)$ – seasonal operator of autoregressive process AR(P)

$\Theta_Q(B^s)$ – seasonal operator of moving average MA(Q)

a_t – error term (white noise)

s – orders of season ($B^s y_t = y_{t-s}$)

d, D – nonseasonal and seasonal orders of differencing (integration)

Then, using more parsimonious notation, we can rewrite (2) as follows:

$$\text{ARIMA}(p, d, q)(P, D, Q)_s, \quad (1.3)$$

where: p, P – number of autoregressive parameters

q, Q – number of moving average parameters

The Box-Jenkins approach is iterative three-stage modeling approach – identification, estimation and diagnostic checking, and finally forecasting (see [3]).

1.2 ARIMA-Intervention time series analysis

The trend of time series may be sometimes disturbed by unexpected external shocks which change its long term course. These external shocks are called interventions [2]. Intervention models are special case of linear transfer models. We can define general class of intervention models as follows [4]:

$$Y_t = \sum_{j=1}^k \frac{\omega_j(B)B^{b_j}}{\delta_j(B)} X_{jt} + \frac{\theta(B)}{\psi(B)} a_t \quad (1.4)$$

where $X_{jt}, j = 1, 2, \dots, k$ are intervention dummy variables, which can be *pulse* or *step*. A pulse function represents a temporary event and a step function characterizes a permanent change. We can represent a pulse intervention with a dummy variable 1 in the time periods of the intervention, and 0 in all other periods. A step intervention can be represented with a dummy variable 1 in the time periods in which the event occurs and all subsequent time periods, and 0 at all time periods before the event.

Estimation of intervention model usually goes in two stages. First, using ARIMA methodology we identify the noise series, i.e. the time series till first intervention. Next in the second stage, we estimate coefficients ω_j . The main reason for estimating intervention model is to find out how big the effect of intervention is. If we can estimate the value of intervention, we can than clean the impact of the intervention and get rid of such annoying breaks.

2 MODELING OF EXPORT OF GOODS AND SERVICES OF SLOVAK REPUBLIC

In this section we model the export of goods and services of Slovak Republic using both above described models in order to demonstrate the usefulness of ARIMA-Intervention time series analysis in such situations when development of time series is disturbed by external shocks. Afterward we will compare the results of both models and forecast the future development of the export of Slovak Republic.

2.1 Development of the export of goods and services of Slovak Republic

As it was mentioned in previous part - Slovak Republic is highly opened and export-oriented economy which depends on external economic environment. Germany and Czech Republic are considered the biggest and most important trading partners of Slovak Republic therefore economic situation in these countries has a significant impact on Slovak export opportunities.

In Figure 1, we can observe development of export of Slovak republic. We can identify several trends within the time evolution. Increasing trend in the beginning of the period is substituting by sharp increase from 2005, as a result of the integration of Slovak Republic to the European Union in 2004, which removed trade barriers and thus facilitates movement of goods and services within the European Community. In the first quarter of 2009, we can see a huge decline of export in Slovakia due to the global economic crisis. The revival comes in 2010, when exports start to grow again. At present, we can observe a slight upward trend, which is caused due to the global economic slowdown.

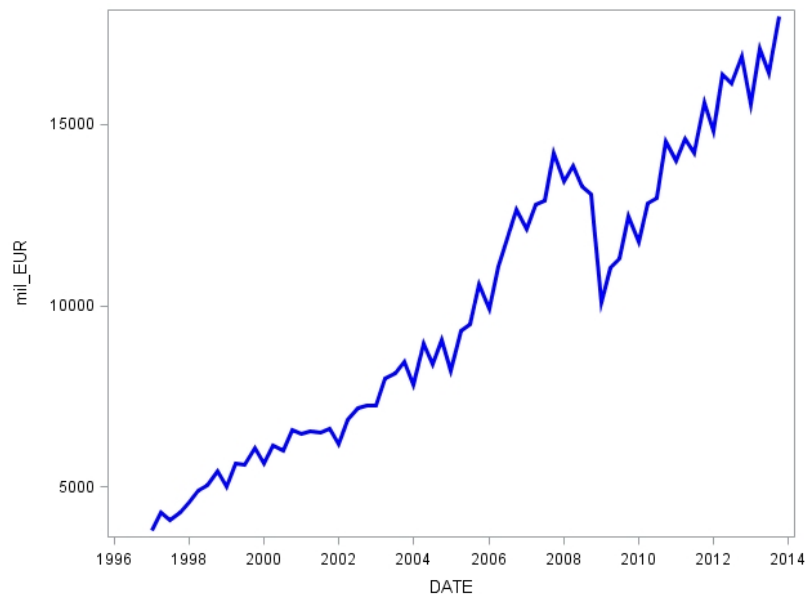

Figure 1 Development of the export of goods and services of Slovak Republic from 1997Q1 to 2013Q4

2.2 ARIMA model of export of goods and services of Slovak Republic

We used stationary time series of export of goods and services of Slovak Republic to fit ARIMA model. After estimation and careful consideration, we have chosen the best fitted model ARIMA (0, 1, 0)(0, 1, 1)₄ written as:

$$(1 - B)(1 - B^4)\ln X_t = (1 - 0,6993B^4)\alpha_t \quad (2.1)$$

(0,0916)

This fitted model does not meet the white noise assumption of homoskedasticity on levels of significant higher than 0,01 which confirms White test with p-value equals 0,0133. Assumption of normality is not met neither since Jarque-Bera test p-value equals 0,0001. Though, residuals are not auto-correlated as Durbin-Watson statistics equals 1,867.

In **Figure 2** we see comparison of real and fitted data of export of goods and services as well as forecast in year 2014. We can notice quite big differences between real and fitted data in the beginning and in the time of the crises in 2009. Mean absolute percentage error equals 3,99 % and standard deviation is 528,59 mil. EUR.

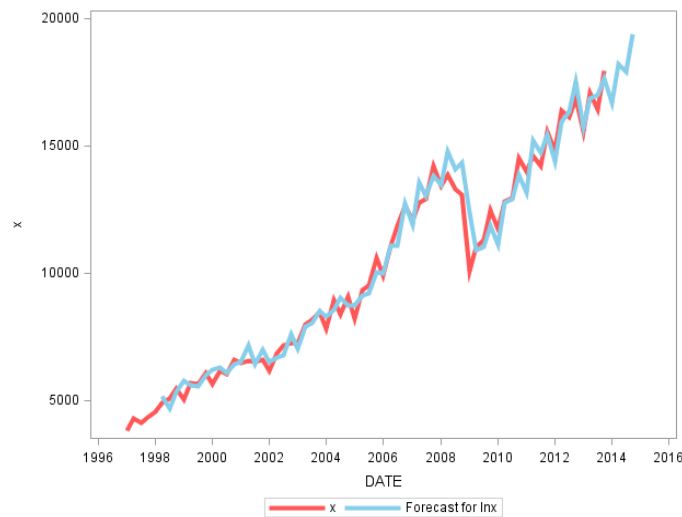

Figure 2 Real data and fitted data of export of goods and services, forecast in year 2014

2.3 ARIMA-intervention model of export of goods and services of Slovak Republic

Previous fitted ARIMA model does not meet white noise assumptions of homoskedasticity and normality and neither fit the development of export in the time of crisis. For these reasons, we attempt to estimate ARIMA intervention model in this section. We build ARIMA model including step function in 2008Q3 (um8) and pulse function in 2009Q1 (um9). After careful consideration, we estimated best model written as:

$$(1 - B)(1 - B^4)\ln X_t = -0,0995um8_t + \frac{-0,1973}{(1 - 0,8493B)}um9_t + (1 - 0,5873B^4)a_t \quad (2.2)$$

(0,0374) (0,03618)/(0,13545) (0,10835)

Unlike the previous simple ARIMA model, fitted intervention model meets the white noise assumptions. Autocorrelation confirms Durbin-Watson statistics of 2,13, normality Jarque-Bera test with p-value equals 0,5849 and homoskedasticity p-value of White test equals 0,0783.

Estimated ARIMA model with intervention fits the development of export in the time of crisis and after that much better than previous simple ARIMA as we can see in Figure 3. Mean absolute percentage error is lower and equals 3,11 % and standard deviation is 377,75 mil. EUR. Forecast for 2014Q1 of export of Slovak Republic is 16811,19 mil. Eur.



Figure 3: Real data and fitted data of export of goods and services, forecast in year 2014

3 CONCLUSION

As we shown, simple ARIMA model does not fulfill white noise assumption and there are quite big differences between real and fitted data in the time of the crises starting from 2008Q3. Therefore we built ARIMA Intervention Model which included global economic crisis as the intervention of the time series. We achieved much better results - decreasing of mean absolute percentage error, model met the white noise assumptions and also estimated the time of crisis very reliably. Last, we demonstrated that the ARIMA Intervention Model is very useful in explaining the dynamics of the impact of serious interruptions in an economy and we should use it in such situations when external event or shock occurs.

Acknowledgements: This paper has been elaborated in the framework of the project Opportunity for young researchers, reg. no. CZ.1.07/2.3.00/30.0016, supported by Operational Programme Education for Competitiveness and co-financed by the European Social Fund and the state budget of the Czech Republic.

References

- [1] Box, G. E. P., Jenkins, G. M. and Reinsel, G. C. (2008) *Time Series Analysis: Forecasting and Control*. John Wiley & Sons Inc., New York.
- [2] Box, G. E. P. and Tiao, G. C. (1975) 'Intervention analysis with applications to economic and environmental problems', *Journal of the American Statistical Association*, vol. 70, no. 349, pp. 70-79.
- [3] Ďurka, P. and Pastoreková, S. (2012) 'ARIMA vs. ARIMAX - which approach is better to analyze and forecast macroeconomic time series?', *Mathematical Methods in Economics 2013 – Conference Proceedings*, The Czech Society for Operations Research Conference, Karviná, pp. 136-140.
- [4] MAREK, L. (1998) 'Intervention analysis and outliers in time series', *Štatistické metódy v praxi 1998 : medzinárodný zborník vedeckých prác*, Slovenská štatistická a demografická spoločnosť, Bratislava, pp. 3-16. ISBN 80-967658-8-4,
- [5] Marek, L. (2000) 'Transfer function models', *Acta Oeconomica Pragensia*, vol. 8, no. 3, pp. 83-94
- [6] Pankratz, A. (1991) *Forecasting with Dynamic Regression Models*, Wiley-Interscience.
- [7] Rublíková, E. and Marek, L. (2001) 'Linear transfer function model for outflow rates', *Ekonomické rozhlady*, vol. 30, no. 4, pp. 457-466

Author's address

Ing. Silvia Pastoreková, PhD.

VŠB – Technical University of Ostrava, Faculty of Economics, Department of Systems Engineering

Sokolská třída 33, 701 21 Ostrava

Czech Republic

email: silvia.pastorekova@vsb.cz

SYNCHRONIZATION OF VEHICLE ROUTING PROBLEM IN TWO PERIODS

*Juraj Pekár, Ivan Brežina, Zuzana Čičková,
University of Economics in Bratislava*

Abstract

The vehicle routing problem is one of the most important problems in the field of logistics, which importance leads to many practical applications because of the classical version of vehicle routing problem can be extended by different types of additional conditions. This article deals with synchronization of distribution in two time periods based on classical vehicle routing problem, in case the periods differ in quantity of demand of customers. The goal could be, except the minimization of the total distance, to achieve the stability of solution between the periods.

Keywords: vehicle routing problem, two periods vehicle routing problem

JEL Classification: C61, C90, L91

AMS Classification: 90C08, 90C90

1 INTRODUCTION

The logistics is focused on supply chains management that is aimed on the material flows from acquiring raw materials, their transformation in production process to the final products and the transport to the end customers. One of the most important and well-known problems in the fields of transportation, distribution and logistics is vehicle routing problem (VRP) (e.g. [1], [2], [3], [4], [5], [9]).

The management of physical distribution of commodities is interesting not only for its practical relevance, but also for theoretical research, because a lot of related problems belong to the NP-hard problems. The known routing problem is traveling salesman problem (TSP) (e.g. [6], [7], [9], [10]). The classical version of that problem could be extended by a wide variety of additional conditions. Corresponding problems are e.g. multiple salesman problem, multi depot traveling salesman problem, group traveling salesman problem, one of set traveling salesman problem, traveling purchaser problem, open traveling salesman problem, vehicle routing problem, multi depot vehicle routing problem, fleet size and mix vehicle routing problem, open vehicle routing problem, period vehicle routing problem, vehicle routing problem with simultaneous delivery and pickup, inventory vehicle routing problem, stochastic vehicle routing problem etc. (e.g. [1], [2], [3], [4], [5], [9]). The economic impact of optimization of these problems can lead to considerable savings in logistic costs and in that way to increase the competitive advantage of many companies.

We extended the classical version of VRP considering different demand of customers within two periods in that the known demand of each customer in the 1-st period could be changed in 2-nd period (e.g. [8]). Although the solutions can be searched independently in each period, we prefer stability of solutions in order to reduce the fatigue to drive on the different route. Presented version of VRP leads to optimization problem: to minimize the total distance with the constraint that enables to achieve specific level of similarity of solutions.

2 VEHICLE ROUTING PROBLEM

The standard VRP is the generalization of the known travelling salesman problem (TSP), where we consider the limited capacity of vehicle and the known non-negative demands of customers. This problem consists in designing the optimal set of routes for a vehicle with a certain capacity that is located in a certain depot (origin) in order to serve a given set of customers with a certain

demand, which are located in others nodes of a net (road, rail network etc.). Further on there exist a matrix \mathbf{D} that represents the minimum distance between all the pairs of customers and also between the customers and the depot. The goal is to find optimal vehicle routes (usually minimum distance, length, cost time etc.). The routes must be designed in such a way that each customer is visited only once by exactly one vehicle, all routes start and end at the origin, and the total demands of all customers on one particular route must not exceed the capacity of the vehicle.

3 PROBLEM FORMULATION

The classical version of VRP is defined on graph with n nodes: $G = (V_c \cup V_d, A)$, where

$$\begin{aligned} V_c &= \{v_1, v_2, \dots, v_n\} && \text{– represents set of customers,} \\ V_d &= \{v_0\} && \text{– represents the origin,} \\ A &= \{(v_i, v_j): v_i, v_j \in V_c \cup V_d, i \neq j\} && \text{– the arc set of } G. \end{aligned}$$

A distance (cost) c_{ij} is associated with every arc of the graph. A fleet of vehicles of the same capacity g is located at v_0 . Denote in our case:

$$\begin{aligned} N &= \{1, 2, \dots, n\} && \text{– set of served nodes, } n \text{ represents number of nodes except the origin;} \\ N_0 &= N \cup \{0\} && \text{– set of all nodes, } 0 \text{ represents origin.} \end{aligned}$$

Each customer has a certain demand ($q_i, i \in N$). The classical version of VRP can be stated as follows: The demand is fulfilled from initial node ($i = 0$) – origin. The goal is to determine the minimal travelled distance of vehicles (we suppose that there is known the shortest distance between all nodes $d_{ij}, i, j \in N_0$) with respect to the following restrictions: the origin v_0 represents initial node and also the final node of every route, from the origin the demands $g_i, i \in N$ of all the other nodes is $i \in N$ are met (in full), each node (except central node) is visited exactly once and total demand on route must not exceed the capacity of the vehicle (g), $q_i \leq g, i \in N$.

Mathematical programming formulation of VRP requires two types of variables: the binary variables $x_{ij}, i, j \in N_0$ with a following notation: $x_{ij} = 1$ if the edge between node i and node j is used and $x_{ij} = 0$ otherwise. Further on, we will apply the free variables $u_i, i \in N$ that are based on well-known Miller – Tucker – Zemlin’s formulation of the traveling salesman problem ([7]). Mathematical formulation of the model is given below:

$$\min \sum_{i \in N_0} \sum_{j \in N_0} d_{ij} x_{ij} \tag{1}$$

subject to:

$$\sum_{i \in N_0} x_{ij} = 1 \quad j \in N \quad i \neq j \tag{2}$$

$$\sum_{j \in N_0} x_{ij} = 1 \quad j \in N \quad i \neq j \tag{3}$$

$$u_i + q_j - g(1 - x_{ij}) \leq u_j \quad i \in N_0, j \in N, i \neq j \tag{4}$$

$$q_i \leq u_i \leq g \quad i \in N \tag{5}$$

$$u_0 = 0 \tag{6}$$

$$x_{ij} \in \{0,1\} \quad i, j \in N_0 \quad i \neq j \tag{7}$$

The objective function (1) minimizes a total route travelled by a vehicle (cost of the route). Equations (2) and (3) ensure that a vehicle leaves each node and the vehicle enters each node except the origin exactly ones. Equations (4) represent sub-tour elimination constraints that

simultaneously with the equations (5) and (6) ensure also that the vehicle's capacity is not exceeded.

Consider two periods vehicle routing problem. The periods could differ in demands of customers (g_{1i} , $i \in N$ for the 1-st period, g_{2i} , $i \in N$ for the 2-st period). Then we can employ the objective, which minimizes the total travelled distance in the 1-st period and in the 2-nd period. Then, it could be also interesting to achieve the similarity of solutions in order to avoid big changes of the final route, because of the change in routes could be associated with additional cost. The situation requires us to prefer the use of similar routes in both periods.

The mathematical model will deal with two types of variables for each period: the binary variables x_{1ij} , which represent the use of the edge between node i and node j in the 1-st period route and x_{2ij} , which model the same for the 2-nd period. The variables u_{1i} and u_{2i} represent the cumulative demand of vehicle in corresponding period. Thus the similarity of solutions could be satisfied by using the corresponding edges on the base of individual changes, so that, the total change is equal to $\sum_{i \in N_0} \sum_{j \in N_0} |x_{1ij} - x_{2ij}| \leq c$, where parameter c represents the maximal number of

changed edges between the routes. The mathematical model is given bellow.

$$\min f(\mathbf{X}_1, \mathbf{X}_2, \mathbf{u}_1, \mathbf{u}_2) = \sum_{i \in N_0} \sum_{j \in N_0} d_{ij} x_{1ij} + \sum_{i \in N_0} \sum_{j \in N_0} d_{ij} x_{2ij} \quad (8)$$

subject to:

$$\sum_{i \in N_0} x_{1ij} = 1 \quad j \in N \quad i \neq j \quad (9)$$

$$\sum_{j \in N_0} x_{1ij} = 1 \quad j \in N \quad i \neq j \quad (10)$$

$$(u_{1i} + q_{1j} - u_{1j}) x_{1ij} = 0 \quad i \in N_0, j \in N, i \neq j \quad (11)$$

$$u_{1i} \leq g \quad i \in N \quad (12)$$

$$u_{11} = 0 \quad (13)$$

$$\sum_{i \in N_0} x_{2ij} = 1 \quad j \in N \quad i \neq j \quad (14)$$

$$\sum_{j \in N_0} x_{2ij} = 1 \quad j \in N \quad i \neq j \quad (15)$$

$$(u_{2i} + q_{2j} - u_{2j}) x_{2ij} = 0 \quad i \in N_0, j \in N, i \neq j \quad (16)$$

$$u_{2i} \leq g \quad i \in N \quad (17)$$

$$u_{21} = 0 \quad (18)$$

$$\sum_{i \in N_0} \sum_{j \in N_0} |x_{1ij} - x_{2ij}| \leq c \quad (19)$$

$$x_{1ij} \in \{0, 1\} \quad i, j \in N_0 \quad i \neq j \quad (20)$$

$$x_{2ij} \in \{0, 1\} \quad i, j \in N_0 \quad i \neq j \quad (21)$$

The objective function (8) minimizes a total route travelled in both of periods. Equations (9) - (13) ensure the feasibility of solutions in the 1-st period and equations (14) - (18) ensure the feasibility of solutions in the 2-nd period. Equation (19) takes into accounts the whole changes of the routes.

The corresponding real problems could be solved with the help of adequate software; therefore it could be appropriate to use the model with linear equations. The anti-cycling conditions (11) and (16) could be written in their linear form as follows:

$$u_{1i} + q_{1j} - g(1 - x_{1ij}) \leq u_{1j} \quad i \in N_0, j \in N, i \neq j \tag{22}$$

$$q_{1i} \leq u_{1i} \leq g \quad i \in N \tag{23}$$

$$u_{2i} + q_{2j} - g(1 - x_{2ij}) \leq u_{2j} \quad i \in N_0, j \in N, i \neq j \tag{24}$$

$$q_{2i} \leq u_{2i} \leq g \quad i \in N \tag{25}$$

The equation (19) could be reformulated with the use of slack variables o_{ij} as follows:

$$o_{ij} \geq x_{1ij} - x_{2ij} \quad i, j \in N_0 \quad i \neq j \tag{26}$$

$$o_{ij} \geq x_{2ij} - x_{1ij} \quad i, j \in N_0 \quad i \neq j \tag{27}$$

$$\sum_{i \in N_0} \sum_{j \in N_0} o_{ij} \leq c \tag{28}$$

4 EMPIRICAL RESULTS

In this part, hypothetical application cases of proposed model are presented. The problems were solved on data in Slovak Republic (regional cities: 0 – Banská Bystrica, 1 – Bratislava, 2 – Košice, 3 – Nitra, 4 – Prešov, 5 – Trenčín, 6 – Trnava, 7 – Žilina). The simulations take into account different values of parameter c (maximal number of changes). We will distinguish two marginal cases. The first is to assume the value of the parameter c equal to 0, it means identical distribution in the two periods. Second marginal value of parameter c is limited by number of changes that will ensure optimization of the individual vehicle routing problems in each period.

Input data:

n – number of nodes except the origin = 7;

q_1 – vector of demands for 1-st period = (20, 10, 20, 10, 40, 10, 40);

q_2 – vector of demands for 2-nd period = (20, 30, 10, 40, 20, 10, 40);

g – capacity of the vehicle = 50;

D – matrix of minimal distances between all the pairs of nodes (Table 1).

Table 1. Matrix of minimal distances between all the pairs of nodes

D	0	1	2	3	4	5	6	7
0	0	207.8	212.8	119.4	195.3	141.5	165.8	88.5
1	207.8	0	390.7	88.4	403.1	126.5	47	199.9
2	212.8	390.7	0	302.3	35	302.5	348.7	230.4
3	119.4	88.4	302.3	0	314.7	84.7	46.4	140
4	195.3	403.1	35	314.7	0	293	361.1	220.9
5	141.5	126.5	302.5	84.7	293	0	78	73.4
6	165.8	47	348.7	46.4	361.1	78	0	151.4
7	88.5	199.9	230.4	140	220.9	73.4	151.4	0

Proposed problems were solved using GAMS (Cplex 12.2.0.0).

Solutions of the model for various cases:

a) Individual solution of vehicle routing problem in both periods:

1-st period

vehicle route: 0 – 2 – 4 – 0 – 3 – 1 – 6 – 0 – 5 – 0 – 7 – 0, the cost of the route: 1323.7

2-nd period

vehicle route: 0 – 1 – 6 – 5 – 0 – 2 – 0 – 3 – 7 – 0 – 4 – 0, the cost of the route: 1638.4

the total cost: 2962.1

b) **Simulations for different values of parameter c :**

a) $c = 0, c = 2$

1-st period

vehicle route: 0 – 3 – 1 – 6 – 0 – 4 – 0 – 5 – 2 – 0 – 7 – 0, the cost of the route: 1645

2-nd period

vehicle route: 0 – 3 – 1 – 6 – 0 – 4 – 0 – 5 – 2 – 0 – 7 – 0, the cost of the route: 1645

the total cost: 3290

b) $c = 4, c = 6$

1-st period

vehicle route: 0 – 2 – 4 – 0 – 5 – 0 – 6 – 1 – 3 – 0 – 7 – 0, the cost of the route: 1323.7

2-nd period

vehicle route: 0 – 2 – 5 – 0 – 4 – 0 – 6 – 1 – 3 – 0 – 7 – 0, the cost of the route: 1645

the total cost: 2968.7

c) $c = 8$

1-st period

vehicle route: 0 – 2 – 4 – 0 – 3 – 1 – 6 – 0 – 5 – 0 – 7 – 0, the cost of the route: 1323.7

2-nd period

vehicle route: 0 – 1 – 6 – 5 – 0 – 2 – 0 – 3 – 7 – 0 – 4 – 0, the cost of the route: 1638.4

the total cost: 2962.1

5 CONCLUSION

The paper is focused on the presentation of the two periods vehicle routing problem, because of in the real life, the amount of demand of customers could be changed in time. Although the solutions can be searched independently in each period, in practice it could be preferred stability of solutions in order to reduce the big changes between the individual routes. Presented version of VRP leads not only to optimization of the total distance, but also enables to set a specific level of similarity of solutions. Some examples of practical applications of presented model were reported. The presented results differ in specified value of parameter that is significant to model the similarity of routes.

Acknowledgements: This paper is supported by the Grant Agency of Slovak Republic – VEGA, grant no. 1/0104/12 „Modeling supply chain pricing policy in a competitive environment“.

References

- [1] Brezina, I., Čičková, Z. and Pekár, J. (2012) 'Evolutionary approach as an alternative method for solving the vehicle routing problem' *Ekonomické rozhlady*, vol. 41, no. 2, pp.137–147.
- [2] Čičková, Z. and Brezina, I. (2008) 'An evolutionary approach for solving vehicle routing problem', *Quantitative Methods in Economics: Multiple Criteria Decision Making XVI – Conference Proceedings*, The Slovak Society for Operations Research Conference, Bratislava, pp. 40–44.
- [3] Čičková, Z., Brezina, I. and Pekár, J. (2013) 'Solving the Real-life Vehicle Routing Problem with Time Windows Using Self Organizing Migrating Algorithm' *Ekonomický časopis*, vol. 61, no. 5, pp. 497–513.
- [4] Čičková, Z., Brezina, I. and Pekár, J. (2011) 'A memetic algorithm for solving the vehicle routing problem' *Mathematical Methods in Economics 2011 – Conference Proceedings*, The Czech Society for Operations Research Conference, Jánka Dolina, pp. 125–128.

- [5] Desrosiers, L., Dumas, Y., Solomon, M. M. and Soumis, F. (1995) 'Time constrained routing and scheduling' *Network Routing, vol. 8 of Handbooks in Operations Research and Management Science* (M. O. Ball et al., eds.), North-Holland, pp. 35–139.
- [6] Fábry, J. (2006) *Dynamické okružní a rozvozní úlohy*. Disertační práce. VŠE-FIS, Praha.
- [7] Miller, C.E., Tucker, A.W. and Zemlin, R.A. (1960) 'Integer Programming Formulation of Traveling Salesman Problems' *Journal of the ACM (JACM)*, vol.7, no.4, pp. 326-329
- [8] Murata, T. and Itai, R. (2008) 'Enhancing Solution Similarity in Multi-Objective Vehicle Routing problems with Different Demand Periods' *Vehicle Routing Problem* (Caric, T. and Gold, H., eds.), University Library Rijeka, Rijeka, pp. 99–112 .
- [9] Palúch, S. and Peško, Š. (2006) *Kvantitatívne metódy v logistike*. Žilina : EDIS vydavateľstvo ŽU.
- [10] Peško, Š. (2006) 'Differential evolution for small TSPs with constraints' *4th International Scientific Conference „Challenges in Transport and Communication“ – Conference Proceedings*, Pardubice, pp. 989–994.

Author's address

prof. Ing. Ivan Brezina, CSc., Ing. Zuzana Čičková, PhD., doc. Mgr. Juraj Pekár, PhD.
University of Economics in Bratislava, Faculty of business informatics, Department of
Operations research and Econometrics, Dolnozemska 1/b, 852 35 Bratislava, Slovak Republic
email: brezina@euba.sk, cickova@euba.sk, pekar@euba.sk

CAPACITATED p -MEDIAN PROBLEM ON SPARSE NETWORKS

*Štefan Peško,
University of Žilina*

Abstract

The capacitated p -median problem on sparse network is a special case of the capacitated p -median problem on the connected graph with small number of edges. We propose a new MILP formulation of this problem that exploits SOS1 (Special Ordered Sets) constraints of type one for flow variables. We were able to compute exact solution for medium size instances. We conduct several computational experiments for 62-median and 211-median on instance of Slovak road network with 3821 nodes and 4771 edges with Gurobi solver.

Keywords: *capacitated p -median problem, sparse network, MILP, SOS constraints, Gurobi*

AMS Classification: 90C10, 90C06, 90C27

1 INTRODUCTION

The p -median problem is one of the most widely studied problems in location theory. A detailed instruction to this problem and solution methods appear in Reese [9]. Janáček's school in University of Žilina developed several original methods for practical applications. From the latest works we mention medical service planning Janošiková [5] and network design Janáček [6], Janáček and Kvet [7] which was inspired for this paper.

We will deal with new MILP formulation for the special case of the capacitated p -median problem on the connected graph with small number of edges – on sparse network. We will call it as a SOS formulation. We will propose exploits SOS constraints for reduction of number variables of model. A Special Ordered Set of type One (SOS1) is defined to be a set of variables for which not more than one member from the set may be non-zero in a feasible solution. All such sets are mutually exclusive of each other, the members are not subject to any other discrete conditions and are grouped together consecutively in the data.

We will begin with classical formulation of the capacitated p -median problem. We will use necessary notation and formulation from [1] and [8].

2 CLASSICAL FORMULATION

Consider a graph $G = (V, E)$ where V is set of vertices and E is set of edges. Let M , subset of set V , are candidates for medians. For each vertex $i \in V$ value w_i (nonnegative integer) represents size of its demand. For each candidate $j \in M$ value Q_j represents its capacity. Nonnegative integer coefficients d_{ij} (usually referred to as distances) weighted by demands describe the cost of allocating each vertex $i \in V$ to median $j \in M$. The classical formulation of the capacitated p -median problem in term of bivalent programming (CCpM) is

$$\min v = \sum_{i \in V} \sum_{j \in M} w_i d_{ij} x_{ij} \quad (1)$$

$$\sum_{j \in M} y_j = p \quad (2)$$

$$\sum_{j \in M} x_{ij} = 1 \quad \forall i \in V \quad (3)$$

$$\sum_{i \in V} w_i x_{ij} \leq Q_j y_j \quad \forall j \in M \quad (4)$$

$$x_{ij}, y_j \in \{0,1\} \quad \forall i \in V, \forall j \in M \quad (5)$$

Binary variables x are assigned values: $x_{ij} = 1$ if and only if vertex i is assigned to a median located in vertex j . Binary variables y correspond to location decisions: $y_j = 1$ if and only if vertex j is selected to be a median. The objective (1) is to minimize the sum of allocation cost. To satisfy constraint (2) exactly p medians must be selected. Set partitioning constraints (3) impose that each vertex is assigned to a median. Capacity constraints (4) impose that the sum of the vertex weight in each cluster do not exceed the capacity of the median and forbid the assignment of vertices to unselected medians.

Ceselli and Righini [1] present a branch-and-price algorithm, that exploits column generation, heuristics and branch-and-bound to compute optimal solution for instances with one weights w in objective function (1). Ghoseiri and Ghannadpour [2] mention good quality of heuristic based on two different assignment techniques namely, classical assignment method and assignment through urgencies are used to assign the demand point to the p selected medians.

Now we show how exploit sparse of networks without necessity computing distances.

3 SOS FORMULATION

The classical formulations usually use a network in Euclidean plane such that distance between any two points in the network is the straight-line distances between them. We will suppose that network is represented by weighted and connected sparse graph $G=(V,E,c)$. For model we define associated digraph $\vec{G} = (V_0, \vec{E}, \vec{c})$ where

- $V_0 = V \cup \{0\}$ with fictive vertex 0,
- $\vec{E} = \{(i, 0) : i \in V\} \cup \{(i, j) : i < j, \{i, j\} \in E\} \cup \{(i, j) : j < i, \{i, j\} \in E\}$,
- $\vec{c}(i, j) = \vec{c}(j, i) = c_{ij}$ for $\{i, j\} \in E$, $\vec{c}(i, 0) = 0$ for $i \in V$.

The cluster of each median is presented by rooted tree with root as the median. Solution is so possible represented by a forest with p trees. After adding the oriented edges from medians to fictive vertex we can find the solution in the form spanning tree in digraph \vec{G} . For easier interpretation we use following notation

- $V^+(i) = \{j \in V_0 : (i, j) \in \vec{E}\}$ – set of successors of vertex $i \in V$,
- $V^-(i) = \{j \in V_0 : (j, i) \in \vec{E}\}$ – set of predecessors of vertex $i \in V$.

As in the CCpM problem, M notes the set of candidates of medians. Then the problem can be formulated as following MILP problem (SCpM):

$$\min v = \sum_{(i,j) \in \vec{E}} \vec{c}(i,j) z_{ij} \tag{6}$$

$$\sum_{j \in M} y_j = p \tag{7}$$

$$\sum_{i \in M} z_{i0} = \sum_{i \in V} w_i \tag{8}$$

$$\sum_{j \in V^+(i)} z_{ij} = \sum_{j \in V^-(i)} z_{ji} + w_i \quad \forall i \in V \tag{9}$$

$$z_{i0} \leq Q_i y_i \quad \forall i \in M \tag{10}$$

$$\{z_{ij}: j \in V^+(i)\} \in SOS\ 1 \quad \forall i \in V \tag{11}$$

$$z_{ij} \geq 0 \quad \forall (i,j) \in \vec{E} \tag{12}$$

$$y_j \in \{0,1\} \quad \forall j \in M \tag{13}$$

The flow variable z_{ij} specifies the number of units of elements which flow by oriented edge $(i,j) \in \vec{E}$. One value of binary variable y_j locate median as in the CCpM problem.

The objective (6) is to minimize the sum of allocation cost in the form of total weighted flow. The constraint (7) fixed the number of medians p . The constraint (8) forcing assignment all demands in vertices. Flow constraint (9) defines, via oriented edges with positive flow, a tree with root in median. Size of cluster capacity is represented by value of flow to fictive vertex 0 by constraint (10). The SOS1 constraint (11) guarantees that every vertex $i \in V$ has exactly at most one father and so the solution is, thanks to flow constraint, in the form of spanning tree in digraph \vec{G} . The decision constraint for the median location is given by (13). We can clam the flow variables (12) nonnegative real only because for fixed decision variables y constraints (8),(9),(11) solution creates spanning tree with root 0 on modelled digraph..

4 ILLUSTRATIVE EXAMPLE

Let us show a small example of network modelled by a grid graph 5x5 on Figure 1. Assume that length of all edges is 1 and so distance between all vertices Manhattan distance. For easy of calculation we have $V = M = \{1,2,\dots,25\}$ and demands $w_i = 10$ and capacities of medians $Q_i = 70$ for all vertices $i \in V$.

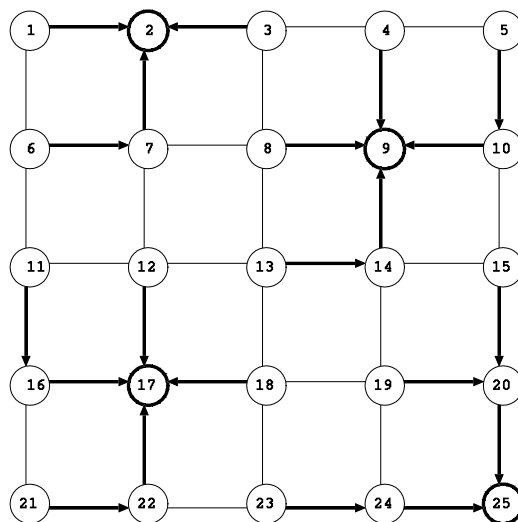

Figure 1: Capacitated 4-median on grid graph 5x5

The solution of our example is pictured on Figure 1 by highlighted lines. The 4-median is set equal $\{2,9,17,25\}$. For each vertex which is not median exists one path to assigned median. For example vertex 23 is assigned to vertex 25 via path $23 \rightarrow 24 \rightarrow 25$. For every median k is assigned cluster C_k with the capacity limited by 70, $C_2 = \{1,2,3,6,7\}$ with demands equal 50, $C_9 = \{4,5,8,9,10,13,14\}$ with demands 70, $C_{17} = \{11,12,16,17,18,26,27\}$ with demands equal 70 and $C_{25} = \{15,19,20,23,24,25\}$ with demands equal 60 units. The optimal value of objective function is $v=290$. In practical instances we can meet with cases where some vertex is modelled as crossroad. Then corresponded demands are equal zero. Assume now that vertices 7 and 14 have $w_7 = w_{14} = 0$ and otherwise 10. Then corresponding solution is on Figure 2.

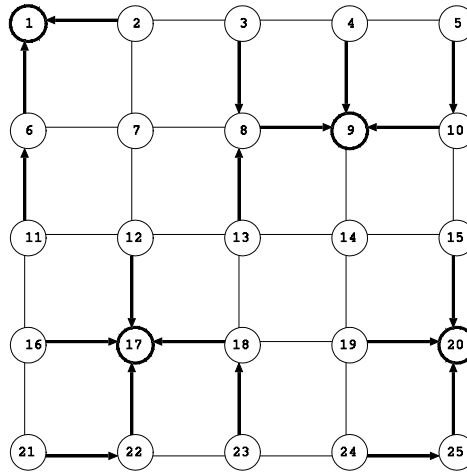

Figure 2: Capacitated 4-median on grid graph 5x5 with 2 crossroads

We can see that crossroads 7 and 14 are not in clusters of solution of optimal 4-median solution $\{1,9,17,20\}$ with value of objective function $v=260$. Note that on some sparse networks a solution with crossroads in clusters can exist.

5 COMPUTATIONAL RESULTS

The computations reported in this section have been carried out on a 8-core XEON, 3 Ghz, RAM 16 GB. We used the Python 2.7.6. API for Gurobi MILP solver [3] and for graph manipulation and visualisation use the NetworkX Python module [4].

In Tables 1 and 2 we will report a preliminary computational experience giving evidence of difficulty of solving 62-median and 211-median on SR instance of Slovak road network with 3821 nodes and 4771 edges. We compare the computational time (CPU sec.) spent by Gurobi for set of k candidates on p -median $M_k(p)$ for $k \in \{1,2,\dots,17\}$ defined as follows

$M_k(p) = \{ \pi(i) \in V: 1 \leq i \leq p+k \}$ where $w_{\pi(1)} \geq w_{\pi(2)} \geq \dots \geq w_{\pi(p+k)}$ and π is permutations defined on set of vertices V of size $n=|V|$. The set of candidates $M_k(p)$ so contains subset of vertices with $p+k$ biggest demands. We will note v_{150000} and v_{200000} optimum cost of objective function (6) for $Q=150000$ and $Q=200000$ setting for all $i \in M_k(p)$.

Tab. 1: Computation of 61-median for SR instances with $Q=150000$ and $Q=200000$

k	$W_{\pi(61+k)}$	V_{150000}	Runtime	V_{200000}	Runtime
1	16334	48957165.8	10.17	47927478.1	2.63
2	16214	48555107.6	*13896.50	47525188.5	13.90
3	15655	48408533.2	34.93	47378570.5	*53448.84
4	15652	48022158.4	20.99	47201422.7	6.57
5	15147	47826859.7	54.33	46978979.4	15.97
6	15062	47290765.9	241.34	46439104.2	20.85
7	14796	47216353.0	102.78	46386611.4	167.35
8	14466	46794048.7	61.08	45951110.8	186.94
9	14159	45955109.7	1777.54	45273626.0	5.46
10	12853	44980075.8	377.69	44280067.3	118.31
11	12815	44390119.4	949.10	43686230.6	8.31
12	12801	44268286.6	8.4	43563472.7	10.27
13	12715	43107092.3	12.50	42989463.0	9.35
14	12267	43082231.1	541.33	42909038.4	281.86
15	11602	42329984.9	5237.07	42112502.2	472.49
16	11469	42332263.4	2061.12	42112502.2	6497.43
17	11313	42378034.0	*8694.74	42073544.1	8456.81

In Table 1 we can see that computational time is difficult to predict. For instances with runtime in seconds which are marked * solving was interrupted with gap form 0.05% to 1.35%. We were surprised as significant changes in length of runtime.

In Table 2 are marked by * solving interrupted by time limit with gap from 0.04% to 0.11%. For growth of parameter Q it was confirmed the reduced computational time in most cases for both sets of instances.

Tab. 2: Computation of 211-median for SR instances with $Q=150000$ and $Q=200000$

k	$W_{\pi(211+k)}$	V_{150000}	Runtime	V_{200000}	Runtime
1	3683	18626531.0	3.58	18626531.0	4.40
2	3672	18612215.2	6.03	18612215.2	8.24
3	3627	18573720.0	15.30	18573720.0	12.31
4	3602	18518218.4	71.92	18518218.4	67.96
5	3577	18518218.4	419.55	18518218.4	420.21
6	3572	18468312.6	958.77	18468312.6	800.45
7	3545	18440656.2	1595.69	18435611.2	1500.01
8	3521	18409768.6	8595.69	18400861.5	*10801.25
9	3503	18411174.1	*10800.77	18365784.0	*10800.33

6 CONCLUSION

This paper introduced new MILP model with SOS1 constraints for solving the capacitated p -median problem on sparse network. Experiments on the real SR instance shows that this formulation of p -median in sparse network is applicable for small candidate sets.

Acknowledgements: The research was supported by the research grants VEGA 1/0296/12 Public Service Systems with Fair Access to Service and APVV-0760-11 Designing of Fair Service Systems on Transportation Networks.

References

- [1] Ceselli, A. and Righini, G. (2005) ‘A branch-and-price algorithm for the capacitated p-median problem’, *Networks*, vol. 45, no. 3, May, pp. 125 – 142.
- [2] Ghoseiri, K. and Ghannadpour, S. F. (2009) ‘An efficient heuristic method for capacitated p-median problem’, *International Journal of Management Science and Engineering Management*, Word Academic Union, England, vol. 4, no.1, pp 72–80.
- [3] *Gurobi Optimizer Reference Manual*, (2012) [Online], Available: <http://www.gurobi.com>.
- [4] Hagberg A.A., Schult, D.A. and Swart, P.J. (2008) ‘Exploring network structure, dynamics, and function using NetworkX’, *Proceedings of the 7th Python in Science Conference (SciPy2008)*, Pasadena, CA USA, pp. 11–15.
- [5] Janošíková L. (2007) ‘Emergency Medical Service Planning’, *Communications - Scientific Letters of the University of Žilina*, vol. 9, no. 2, pp. 64–68.
- [6] Janáček, J. (2011) ‘Lower bound on large p-median problem using the sequential zone adjustment method’, *Mathematical Methods in Economics 2011 – Conference Proceedings*, The Czech Society for Operations Research Conference, Jánska Dolina, pp. 317–320.
- [7] Janáček, J. and Kvet, M. (2012) ‘Sequential zone adjustment for approximate solving of large p-median problems’, *Operations research proceedings 2011 - selected papers of the International conference on operations research*, Zurich, Switzerland, pp. 269 – 274.
- [8] Yaghini, M., Momeni, M., Sarmadi, M and Ahadi, H.R. (2013) ‘An efficient heuristic algorithm for the capacitated p-median problem’, *4OR-Q J Oper Res*, vol. 11, pp. 229 – 248.
- [9] Reese, J. (2006) ‘Solution methods for p-median problem: An annotated bibliography’, *Networks*, vol. 48, no. 3, pp. 125 - 142.

Author’s address

doc. RNDr. Štefan Peško, CSc.
University of Žilina, Faculty of Management Science and Informatics,
Univerzitná 8215/1, 010 26
Žilina,
Slovak Republic
email: stefan.pesko@fri.uniza.sk

BEHAVIOR OF SLOVAK ECONOMY INTEGRATED INTO EMU: DSGE MODEL WITH A GOVERNMENT SECTOR AND INFLATION TARGETING

*Vratislav Pisca, Osvald Vašíček,
Masaryk University, Brno*

Abstract

In the paper we compare the behaviour and structure of Slovak economy in two periods: before and after the accession to the Eurozone. This small open economy is represented by two alternative specifications of medium scale nonlinear dynamic stochastic model of a general equilibrium with fiscal and monetary policy. In the period before accession to the Eurozone, domestic economy has its own monetary policy and after accession it is controlled by monetary policy of ECB. The models are estimated with the use of bayesian techniques. This approach leads to analysis of behaviour of Slovak economy and to the identification of the structural changes linked to the adoption of the Euro and European monetary policy, which seems to be one of the reasons of faster recovery of Slovak economy from recession to the balanced growth path than in the rest of the central European countries.

Keywords: nonlinear DSGE model, Slovak economy, monetary union, inflation targeting, fiscal policy, structural changes.

JEL classification: E32, E58

AMS classification: 91B64

INTRODUCTION

In January 2009, Slovakia adopted euro as official currency and became a member of the Eurozone. This fact is very important for Slovak economy, because now the Slovak economy is more reliable for its business partners and it is easier to trade with its European partners, because there is no exchange rate risk anymore. As a consequence, some structural relationships changed in the in the Slovak economy. Therefore, we decided to analyse these changes with use of a model of the Slovak economy estimated on two data samples divided by the moment of the accession to the Eurozone.

For that purpose we use a small open economy DSGE model, whose structure stems from a Portuguese approach introduced in Almeida [1]. Slovak and Portuguese economy have many similarities. For example, according to IMF, gross domestic product per capita of Slovakia was 24 142 USD and in Portugal it was 23 047 USD in 2012. Portuguese model is designed for an economy integrated into a monetary union, and we used it for estimation of the model of Slovak economy in the period after accession. We had to reintroduce domestic monetary policy and the exchange rate into the model concept in order to estimate the model parameters in the period before accession. The domestic monetary policy is modelled by a Taylor rule, where the domestic nominal interest rate is adjusted in response to the deviations of inflation rate from the inflation target and also to the deviations of GDP from its potential.

1 STRUCTURE OF THE MODEL

Since, we mainly wanted to examine the changes of development of the Slovak economy after its accession to the monetary union, we decided to use the model framework developed by Almeida [1], that was designed for the Portuguese economy. Structure of the model is quite standard, therefore, we will describe only the most important features of the economy represented by model.

The model contains six general parts: households, firms, aggregators, government central bank and foreign sector.

1.1 Households

The households maximize their discounted lifetime utility, which is positive in difference of consumption and consumption habit and negative in labour supply. The households maximize their lifetime utility by choosing a level of real consumption, real investment, (next period) domestic bonds holdings and (next period) foreign bonds holdings subject to budget constraint and capital accumulation equation.

The households receive resources from: the domestic and foreign bonds, which yield the domestic nominal interest rate and risk-adjusted foreign nominal interest rate respectively. Foreign bonds risk-premium is a decreasing function of the real stationary holdings of foreign assets of the entire domestic economy and an increasing function of the risk-premium shock. The households also obtain resources from: participating in the market of state-contingent securities, from government in form of transfers and collects profits of firms in form of dividends.

The households supply differentiated labour. This fact gives the households some market power and enables them to charge additional markup for the supplied labour. A Calvo-type wage rigidity is assumed in the model (calvo parameter ξ^w). The households that cannot reoptimize their wage only update their wage in accordance with current period inflation target, previous period inflation rate and current period growth rate of the permanent technology shock.

1.2 Firms

In the model, there are intermediate and final good firms. Intermediate good firms are of three types: domestic, import and composite good firms. Four types of final good firms are assumed: consumption, investment, government consumption and export firms.

Domestic good firms

Domestic good firms rent capital, and hire labour to produce heterogeneous domestic good. The good is produced using the Cobb-Douglas technology. The domestic good firms hire labour and rent capital in perfectly competitive markets and take the wage and rental rate of capital as given.

Import goods firms

Import good firms buy a homogenous foreign good and differentiate it into import good by brand naming.

Composite goods firms

There is one composite good firm that combines the homogeneous domestic good and import good to produce homogeneous composite good via CES production function. Both input and output markets where the composite good firm operates are perfectly competitive, and thus, the firm takes all prices as given.

Final goods firms

There are four types of final good firms: private consumption, investment, government consumption and export. Final good firms buy a certain amount of composite good and differentiate it by brand naming to produce heterogeneous final good. All input markets of final good firms are perfectly competitive and the firms take the input price as given.

All kinds of final good firms operate on monopolistically competitive markets of their respective output and this fact allows them to charge an additional markup over the marginal costs and to generate profits. Calvo-type rigidities of final good prices are assumed in the model. If a firm cannot reoptimize its price, it only adjusts the price to the current inflation rate target and to the previous period inflation of its respective good.

1.3 Aggregators

The mismatch between the supply of differentiated products and labour and the demand for homogeneous products and labour is solved by aggregators. Labour and each type of product have one respective aggregator that buys all the different varieties and combines them to produce

homogeneous product via CES technology. Each aggregator operates in a perfectly competitive market of its input and output, therefore, it takes prices as given.

1.4 Government

The government obtains its resources from consumption and income taxes and issuance of domestic bonds, and spends the resources on government consumption goods, transfers to the households and payment of debt services. In order to prevent explosive debt path, a fiscal rule is assumed. Debt to GDP ratio cannot permanently exceed the target value $b = \left(\frac{B}{GDP}\right)^{tar}$. If this situation occurs, transfers automatically decrease in order to lower the government deficit and satisfy the fiscal rule in the long-run. The taxes and government consumption are given exogenously as shocks.

1.5 Central bank

We extended the original model of Almeida [1] with the domestic monetary authority, which allows us to model the independent monetary policy of the National Bank of Slovakia in the period before the accession to the monetary union. Monetary authority sets the nominal interest rate in accordance with Taylor type interest rate rule in order to reach the inflation target and keep the output gap closed. Furthermore, the Taylor rule contains a smoothing parameter ρ^{mp} , which leads to a gradual adjustment of the interest rate. Deviations from the Taylor rule are modelled as discretionary monetary policy shocks.

1.5 Foreign sector

The foreign variables are assumed to be exogenously given as AR-processes. The foreign demand for domestic export goods depends on the nominal exchange rate, the share of foreign and domestic price levels, foreign output and foreign elasticity of substitution between domestic export good and foreign good. Moreover, nominal exchange rate adjusts the income from foreign bonds so as to fulfil the uncovered interest parity. The income from domestic bonds must be equal to the income from foreign bonds. We designed the relation between the real and nominal exchange rates in line with Zeman, Senaj [4].

2 DATA AND CALIBRATION

2.1 Data

The time series of seventeen observed variables are used for the estimation of the model. The Slovak economy is described by: gross domestic product (gdp), consumption (C), investment (I), government consumption (G), export (E), import (M), nominal interest rate (r), real wage (w), employment (L), inflation target ($\bar{\pi}$) and three types of inflation: GDP inflation (π^d), consumption good inflation (π) and investment good inflation (π^i). The foreign sector is represented by the time series of gross domestic product (y^*), CPI inflation (π^*) and nominal interest rate (r^*) of 12 Euro area countries. SKK/EUR real exchange rate ($REER$) is used to link the domestic economy with the foreign sector. Fifteen time series were obtained from Eurostat. Real exchange rate was obtained from the ECB database and the inflation target was extracted from NBS annual reports. Sixteen time series contain quarterly data from a period 1Q1999 to 3Q2013, of total length of 59 observations. The time series of the inflation target starts in 1Q2001, so its length is only 51 observations. Each time series was stationarised the same way as was used in Almeida and Félix [2] with use of the HP-filter with $\lambda = 7680$. We divided the dataset into a pre-entry period of 1Q1999-4Q2008 containing 40 observations and post-entry period of 1Q2009-3Q2013 containing 19 observations.

2.2 Calibration

The same calibration and priors were used for both estimations. We decided to calibrate 11 parameters. Depreciation of capital (δ) was set to 0.014, which corresponds to an annual

depreciation rate of 5.6%. Growth of permanent technology ζ was set to 1.005, which implies annual potential output growth of 2%. Steady state inflation π was set to 1.005, which is consistent with inflation goal 2% in the European Union. The discount rate β was set to 0.999 to produce a steady-state long-run nominal interest rate of 4.5%. Target debt to GDP ratio was set in line with Slovak fiscal policy to $b_{tar} = 0.6$. Two calibrations of parameters were obtained from data. Steady-state government to output ratio g_y was set to 0.395, and the share of domestic exports in EA12 output ω_{for} was set to 0.003. The rest of the parameters were set in line with Almeida [1]: Consumption tax ($t^c = 0.304$), income tax ($t^l = 0.287$), productivity of capital ($\alpha^d = 0.323$) and fiscal rule parameter ($d_g = 0.9$). Priors of the Taylor rule parameters were obtained from Senaj, Výškrabka, Zeman [3] ($\rho^{mp} = 0.8$; $\phi_{mp}^\pi = 1.8$; $\phi_{mp}^{gap} = 0.2$).

3 ESTIMATION AND RESULTS

As was mentioned above, we performed two separate estimations, with the same calibration and priors. The only difference was in the dataset used for each estimation. Estimation was carried out in matlab with use of dynare toolbox, version 4.3.3. Two chains of Metropolis-Hastings algorithm with 1.000.000 replications each and drop rate set to 0.6 were generated. Table 1 presents the posterior estimates of structural and shock parameters of both estimations. Note that, the Great recession began only one period before Slovak accession to the monetary union, so it is nearly impossible to distinguish the effects of these two events in the obtained results. The most considerable changes occur in two elasticity parameters. We can recognize increase in elasticity of substitution between domestic and import intermediate good in production of composite good v^h . This result is in line with our expectations, because monetary union implies weaker barriers of trade and lower transaction costs, therefore, substitution of domestic goods for imported goods should become easier. Next, we can see a decrease in the elasticity of risk premium. Additional important changes of structural parameters are related to prices. We can see a decline of markup of domestic goods μ^d from 2.12 to 1.69, which can be interpreted as a higher degree of competition on this market. According to the posterior estimates of the Calvo parameters, the average duration of the prices changed from 1.96 quarters (6 months) to 2.77 quarters (8 months) on the market of government consumption goods, and it increased from 3.22 quarters (9 months) to 7.14 quarters (1 year and 9 months) on the market of domestic intermediate goods.

We decided to consider the parameters that changed by less than 5% to be deep. Calvo parameters of export goods and consumption goods can be considered to be relatively stable. Further, deep parameters are: indexation to previous inflation of domestic goods, markups of consumption goods, government consumption goods and investment goods. The stability of consumption habit of households is in line with our expectation, because people do not have a reason to change their habits after the accession to the currency union, because their preferences are stable.

Table 1: Priors and posteriors of the structural and shock parameters

Parameters	Prior Distrib ution	Prior Mean	Prior Standard deviation	Posterior mean Off - EMU	Posterior mean In - EMU
v^h Import elasticity	Normal	1.000001	0.50	0.4836	1.0919
v^{for} For. Elasticity export	Normal	1.50	0.75	1.2933	1.3450
ω^h Import share	Beta	0.32	0.05	0.1790	0.2970
σ^l Labour elasticity	InvG	2.30	0.15	2.3054	2.3033
h Consumption habit	Beta	0.64	0.05	0.7190	0.7365
μ^w Wage markup	InvG	1.25	0.10	1.5009	1.2703
μ^d Domestic markup	InvG	1.50	0.35	2.1235	1.6994
μ^m Import markup	InvG	1.20	0.10	1.1264	1.2143

μ^c	Consumption markup	InvG	1.20	0.025	1.1888	1.1779
μ^i	Investment markup	InvG	1.05	0.05	1.0621	1.0323
μ^g	Government markup	InvG	1.05	0.05	1.0430	1.0632
μ^e	Export markup	InvG	1.50	0.10	1.4725	1.4996
S	Investment adjustment cost	Normal	7.70	1.50	8.7072	8.2327
ξ^w	Wage calvo	Beta	0.80	0.05	0.7311	0.7693
ξ^d	Domestic calvo	Beta	0.74	0.10	0.6956	0.8576
ξ^m	Import calvo	Beta	0.50	0.05	0.4480	0.4702
ξ^c	Consumption calvo	Beta	0.80	0.12	0.7716	0.8070
ξ^i	Investment calvo	Beta	0.80	0.10	0.4900	0.5871
ξ^g	Government calvo	Beta	0.60	0.10	0.4932	0.6422
ξ^e	Export calvo	Beta	0.73	0.10	0.8392	0.8614
χ	Elasticity of risk premium	Beta	0.035	0.015	0.0699	0.0350
κ^w	Wage indexation	Beta	0.50	0.10	0.3871	0.5579
κ^d	Domestic indexation	Beta	0.50	0.10	0.5331	0.5210
κ^m	Import indexation	Beta	0.50	0.10	0.4383	0.4758
κ^c	Consumption indexation	Beta	0.50	0.10	0.4721	0.5363
κ^i	Investment indexation	Beta	0.50	0.10	0.5031	0.4705
κ^g	Government indexation	Beta	0.50	0.10	0.4546	0.4813
κ^e	Indexation export	Beta	0.50	0.10	0.4814	0.4750
ϕ_{mp}^π	Taylor rule, inflation	Gamma	1.80	0.15	1.6788	-
ϕ_{mp}^{gdp}	Taylor rule, output	Gamma	0.20	0.05	0.1684	-
ρ^{mp}	Taylor rule, smoothing	Beta	0.80	0.10	0.6722	-
Shock AR-coefficients						
ρ^{ε^i}	Investment	Beta	0.39	0.10	0.4016	0.3530
ρ^{ε^c}	Consumption	Beta	0.59	0.10	0.5730	0.6213
ρ^{ε^ϕ}	Risk premium	Beta	0.75	0.10	0.8180	0.7527
ρ^{ε^a}	Productivity	Beta	0.60	0.10	0.6280	0.6906
ρ^{ε^l}	Labour disutility	Beta	0.62	0.10	0.5062	0.5887
ρ^{μ^d}	Domestic markup	Beta	0.66	0.10	0.4328	0.6625
ρ^{μ^c}	Consumption markup	Beta	0.59	0.10	0.5049	0.6121
ρ^{μ^i}	Investment markup	Beta	0.60	0.10	0.4889	0.5099
ρ^{μ^g}	Government markup	Beta	0.78	0.10	0.5405	0.7030
ρ^{μ^x}	Export markup	Beta	0.62	0.10	0.6302	0.6864
ρ^{μ^m}	Import markup	Beta	0.35	0.10	0.2726	0.3318
ρ^ζ	Technology	Beta	0.53	0.10	0.4541	0.5344
ρ^{ζ^*}	Foreign Technology	Beta	0.87	0.10	0.8628	0.9168
ρ^{τ^l}	Income tax	Beta	0.67	0.10	0.6631	0.6691
ρ^{τ^c}	Consumption tax	Beta	0.74	0.10	0.8224	0.7884
ρ^g	Government consumption	Beta	0.68	0.10	0.6106	0.7665
ρ^{π^*}	Foreign inflation	Beta	0.69	0.10	0.7287	0.7785
$\rho^{\mathcal{Y}^*}$	Foreign output	Beta	0.89	0.08	0.9428	0.9516
ρ^{r^*}	Foreign interest rate	Beta	0.95	0.02	0.9205	0.9219

$\rho^{\bar{\pi}}$	Inflation target	Beta	0.66	0.10	0.4906	0.6624
	Standard deviation of Shocks					
$\sigma_{\eta}^{\varepsilon^i}$	Investment	InvG	0.45	0.45	0.3538	0.3624
$\sigma_{\eta}^{\varepsilon^c}$	Consumption	InvG	0.05	0.10	0.0400	0.0329
$\sigma_{\eta}^{\varepsilon^{\phi}}$	Risk premium	InvG	0.01	0.04	0.0080	0.0022
$\sigma_{\eta}^{\varepsilon^{\alpha}}$	Productivity	InvG	0.025	0.025	0.0095	0.0193
$\sigma_{\eta}^{\varepsilon^l}$	Labour disutility	InvG	1.10	0.20	1.5377	1.0923
$\sigma_{\eta}^{\mu^d}$	Domestic markup	InvG	0.74	0.74	0.3632	0.4293
$\sigma_{\eta}^{\mu^c}$	Consumption markup	InvG	0.20	0.20	0.1268	0.1373
$\sigma_{\eta}^{\mu^i}$	Investment markup	InvG	0.25	0.25	0.1700	0.2268
$\sigma_{\eta}^{\mu^g}$	Government markup	InvG	0.40	0.40	0.3042	0.2247
$\sigma_{\eta}^{\mu^x}$	Export markup	InvG	0.10	0.15	0.1289	0.0942
$\sigma_{\eta}^{\mu^m}$	Import markup	InvG	0.08	0.08	0.3456	0.1630
σ_{η}^{ζ}	Technology	InvG	0.02	0.15	0.0101	0.0097
$\sigma_{\eta}^{\zeta^*}$	Foreign Technology	InvG	0.035	0.10	0.0269	0.0235
$\sigma_{\eta}^{\tau^l}$	Income tax	InvG	0.04	0.04	0.0445	0.0379
$\sigma_{\eta}^{\tau^c}$	Consumption tax	InvG	0.04	0.04	0.0235	0.0136
σ_{η}^g	Government consumption	InvG	0.04	0.04	0.0141	0.0136
$\sigma_{\eta}^{\pi^*}$	Foreign inflation	InvG	0.015	0.15	0.0033	0.0036
$\sigma_{\eta}^{\gamma^*}$	Foreign output	InvG	0.40	0.40	0.3907	0.3279
$\sigma_{\eta}^{r^*}$	Foreign interest rate	InvG	0.02	0.02	0.0049	0.0056
$\sigma_{\eta}^{\bar{\pi}}$	Inflation target	InvG	0.10	0.10	0.0213	0.0250
σ_{η}^{mp}	Monetary policy	InvG	0.01	0.05	0.0080	-

3.1 Shock decomposition

We divided shocks into four groups to analyse effect of groups of shocks on gross domestic product. “Monetary policy” group contains monetary policy shock and shock in inflation target. “Fiscal policy” group contains shocks in consumption tax, income tax and in consumption of the government. “Foreign” group contains shocks in foreign output, foreign nominal interest rate, foreign inflation and in foreign permanent technology. Rest of the shocks then contains shocks in preferences, productivity, permanent technology, markups and in risk premium. Note that, we can see effect of monetary policy even after the accession to the currency union. This is because monetary policy the group contains shock in inflation target.

As we can see in the Figure 1, the response of GDP to the fiscal shock is higher than to the monetary shock in both periods. Influence of the fiscal shock seems to have a negative effect on GDP from 2007 to 2009, which corresponds to a lower government consumption that can be observed in the data. Also, this result can be partially attributed to the permanent technology shock, that increased the steady state level of the GDP in this period. After the accession we can see that shocks in fiscal policy have positive effect on GDP, which is in line with the expansionary policy in the period of global recession. Around 2011, the fiscal policy becomes restrictive and affects the GDP in a negative way. This fact is in line with the European debt crisis and a tendency of European countries to lower their deficits. Besides “rest of the shocks” the group, it is the foreign sector that has the biggest influence on GDP.

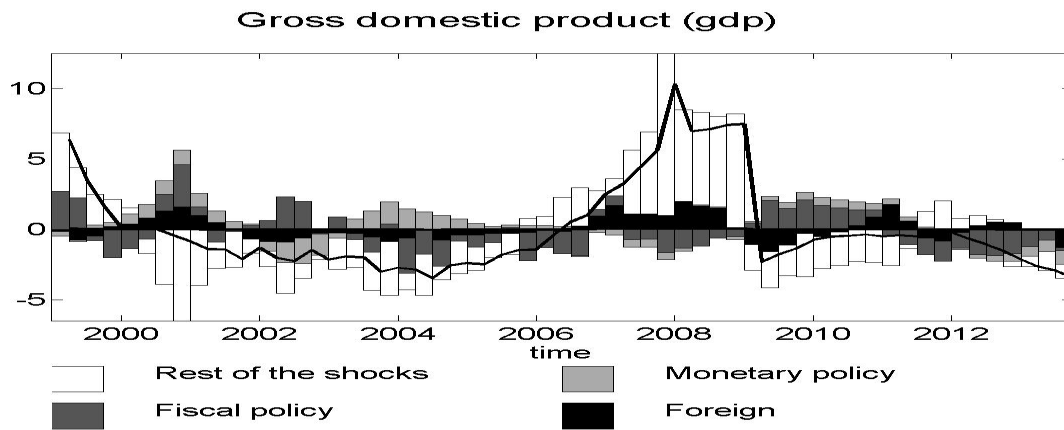

Figure 1: Shock decomposition of Gross domestic product

CONCLUSION

In the paper we analysed structural changes of Slovak economy between the period before and after the accession to the currency union. For this purpose we estimated two similarly specified models. First model, that contained autonomous monetary policy represented by the Taylor rule and the nominal exchange rate, was estimated on dataset of Slovak economy in period from 1Q1999 to 4Q2008. Second specification, where the domestic nominal interest rate was set exogenously and the nominal exchange rate was set equal to one, was estimated on dataset of Slovak economy in period from 1Q2009 to 3Q2013. We analysed the posterior estimates of structural parameters and shock decomposition of the output gap to discover the most significant changes of the structure and behaviour of the Slovak economy.

The main differences were identified in elasticities of production functions and in competitiveness on the market of domestic intermediate goods. On the other hand we found that the competitiveness on markets of labour, government consumption goods and investment goods did not change.

Acknowledgements: This work is supported by funding of specific research at Faculty of Economics and Administration, project MUNI/A/0808/2013.

References

- [1] Almeida, V. (2009) ‘Bayesian Estimation of a DSGE Model for the Portuguese Economy’, *Bank of Portugal Working Papers Series*, no. 14.
- [2] Almeida, V. and Félix, R. (2006) ‘Computing potential output and the output-gap for the Portuguese economy’, *Banco de Portugal - Economic bulletin*, Autumn.
- [3] Senaj, M., Výškrabka, M. and Zeman, J. (2010) ‘MUSE: Monetary Union and Slovak Economy model’, *NBS Working paper series*, no. 1.
- [4] Zeman, J. and Senaj, M. (2009) ‘DSGE model – Slovakia’, *National Bank of Slovakia, Working paper*, no. 3.

Authors’ address

Ing. Vratislav Pisca, Prof. Ing. Osvald Vašíček, CSc.

Masaryk University, Faculty of Economics and Administration, Department of Economics

Lipová41a, 602 00 Brno

Czech republic

email: 385260@mail.muni.cz and osvald@econ.muni.cz

PARTIAL SERVICE ROUTES WITH MULTIPLE VISITS TO EDGES

*Vladimír Přibyl,¹ Anna Černá,¹ Jan Černý,¹ Maddalena Nonat,²
University of Economics in Prague¹
Engineering Department University of Ferrara, Italy²*

Abstract

This paper deals with searching for a “best” circular service route passing through a given road network represented by an undirected graph. Each edge is characterized by a generalized cost, e.g. the length or travel time, and by a benefit associated to the importance of serving that edge. All these parameters are positive. The sought service route should meet a cost limit constraint and maximize the route benefit. The route does not need to be elementary, since edges can be traversed multiple times. However, the benefit associated to each traversal of an edge decreases as the number of traversals increases. The total benefit of a service route is defined as the sum of the benefits provided by each individual traversal of each edge of the route.

Keywords: *circular service route, multiple edge traversals, optimization, depth-first-search*

JEL Classification: C44

AMS Classification: 05C38, 90B10

1 INTRODUCTION

A given road network is modeled as an undirected graph $G = (V, E, c, g_n)$ where c and g are defined on the edge set E ; $c(e) > 0$ is the cost of traversing edge $e \in E$ (e.g. modeling time, length, genuine cost, fuel or water consumption and so on, depending on the application) and $g_n(e) \geq 0$ is the “importance” of providing service (e.g. by a watering truck, etc.) to edge e for the n^{th} time and it will be referred to as the n^{th} benefit of the edge. If r is a route on G then the cost $c(r)$ of route r is the sum over all edges of the individual cost of the edge time the number of traversals along r , while the route benefit, denoted as $g(r)$, is the sum over all edges of the benefit provided by each traversal of an edge along r .

The **basic problem** (BP) is the following: Given a threshold $c_o > 0$ and a vertex $v_o \in V$. The problem is to find a circular route r from v_o to v_o in the graph G meeting the constraint $c(r) \leq c_o$ and maximizing the route benefit $g(r)$.

BP was studied by [7] and [8] with application to a bus service route, where the importance $g_n(e)$ is related to the number of passengers boarding or alighting the bus when traveling along edge e for the n^{th} time, while the cost $c(e)$ models the bus traveling time along e . Both papers present heuristic methods for the solution of BP, in particular a Simulated Annealing based algorithm was proposed in [8].

The goal of the current paper is to introduce a method based on a depth first search type visit on G and show that it can improve literature results.

2 SIMILAR PROBLEMS IN THE LITERATURE

BP belongs to the family of *circular service route problems*, where a set of clients located on the edges (service on edges, SoE), or at the vertices (service on vertices, SoV) of a graph must be serviced by an agent traveling along a circular route, usually leaving from and returning to a given node v . A further distinction can be made depending on the requirement that the whole set of clients has to be serviced or only a subset, due to the limited availability of one (or more) resource(s) related to the route, such as duration, length, budget and so on. In the latter case, a sort of priority (reward, benefit, prize) is associated to the clients and the feasible route visiting

the most valuable subset is searched. In the former case, usually a cost function associated to the route must be minimized. The most well known representative of the class where all vertices must be visited is the *Traveling Salesman problem*, while the *Chinese Postman problem* is among the most studied problems in the service-on-edges class.

Although BP belongs to SoE class, even in the SoV class some hints can be found for its solution, based on the fact that a vertex u can be expanded into an edge $[u',u'']$. Think for example to the orienteering problem [10], [6], which shares with BP the constraint on the maximum cost of the route as well as the objective function.

In the SoE class, the *Rural Postman problem* [9] requires that only a subset of edges must be visited, while the others can be visited, and this feature can be modeled by a two-values priority function: $c(e) = 1$ if service on e is compulsory, while $c(e) = 0$ if e is optional. In the *Windy Postman problem* [2], [3] the cost function varies according to the direction the edge is traversed. In the *Prize-Collecting Rural Postman problem* [1] edges have a cost and can be traversed several times but only the first traversal provides a reward; the objective function maximizes the total profit minus the route cost.

BP is also related to the *Elementary Resource Constrained Shortest Path Problem* tackled in [4] where resources are accumulated along the path, in case the problem is reformulated on an expanded network in which there is a copy of each edge for each traversal.

However, none of the abovementioned problems considers the case of having the edge benefit associated to multiple traversals of the same edge and not being constant but being a function of the number of times the edge is traversed. This feature is analyzed in [8], whose results the current paper strives to improve, and also in [5] which deals with the design of a cyclo-tourist route of maximum attractiveness, connecting two vertices u and v , with bounded duration, and subject to a budget constraint. When $u = v$, BP is a relaxation of the previous problem, so that the mixed integer linear programming (MILP) formulation developed in [5] can be straightforwardly adapted for the solution of BP. Nevertheless, as an alternative to the use of a MILP solver, this paper presents a very simple exact method of the primary type, i.e. starting from a feasible solution and iteratively improving the value of the objective function until an optimal solution is reached. For large size instances this method can be used as a heuristic, by setting a time out to the running time.

3 COMBINED EXACT-HEURISTIC METHOD AND ITS VERIFICATION

The proposed exact method is based on the combinatorial inspection of all possible routes. The method is based on a “depth first search” type visit of the graph. Clearly, its computational complexity is very high, so that it can be practically used only for small instances, but the optimal solutions reached by the exact method in those cases can be used as a “quality etalons” for heuristic methods. In some cases, if the search is wisely guided, the suboptimal feasible solutions reached by the exact method within a limited time can improve upon those reached by other heuristic methods.

At the beginning of the exact method, the set of the incident edges of each vertex $u \in V$ (the so called star of u denoted by $S(u)$) are ordered according to the value of the edge attributes. We implemented and tested the following two approaches:

- The first variant V1 uses “importance” $g_1(e)$ of the edge e as a descending ordering criterion.
- The second variant V2 uses the ratio $g_1(e)/c(e)$ of the edge e as a descending ordering criterion.

The procedure starts from the initial vertex v and selects the first incident edge in $S(u)$ according to the chosen criterion. Such edge is appended to the current route. If the total length of the new route does not exceed the maximum duration c_0 , the procedure iterates, resuming from the ending vertex of the added edge. Otherwise, the procedure backtracks, the inspected edge is discarded, and the next one in $S(u)$ according to the chosen order is considered. When the route goes back to the initial vertex v , the total demand is computed and compared to that of the incumbent solution. In case of improvement, the current route is saved as the new incumbent solution and the procedure resumes the search, backtracking from the second-to-last node.

3.1 Experimental results

Both the above mentioned variants of the proposed exact method were implemented in relatively slow environment of Visual Basic for Application in MS Access on standard hardware configuration (PC with Windows 7, Intel® Core™ i5 CPU 750@ 2,67 GHz, RAM 4 GB). In order to compare the efficacy, we tested our method on the same instance as in [8], which in turn is the same used in [7], since it is the only one for which all data are reported. The test instance is a network with 25 vertices and 40 edges. For each edge both attributes, i.e., costs $c(e)$ and “importance” $g_1(e)$, are given, as well as the fading strategy for benefit at successive traversals, at which the benefit goes down to one fifth of the initial one, i.e., $g_n(e)=0.2g_1(e)$ for $n>1$. The maximum duration of the route c_0 is set to 100, again accordingly to [7] and [8].

Figures 1 and 2 depict the test network, on which the best route found in [8] (Figure 1) and the route corresponding to our best solution (Figure 2) are highlighted in bold. On each edge, duration and benefit at first traversal are depicted as the pair $c(e).g_1(e)$.

Regarding running time, remind that we are comparing a prematurely terminated exact approach to a meta heuristic. Moreover, since the application concerns a design problem which does not need to be solved in real time, and taking into account the limited performance of the computational environment, we considered about 100 minutes as a reasonable timeout after which the search is interrupted and the incumbent solution is returned. Both variants of the proposed exact method (EM) could not converge within this time limit, so that the global optimality of their solution could not be certified. However, both variants yielded the same solution, and this one improves upon those reached by the heuristics based on Simulated Annealing (SA) reported in [8]. In addition, it is well known that the performance of SA based procedures is quite sensitive to parameter setting. In fact, an intensive and thorough calibration phase was performed in [8] to obtain the parameter setting used to find their best solution. Since such values can be instance dependent, we believe that a fair comparison of computing time can not be done without taking into account the time needed for calibration in addition to the solution time, which the author in [8] report to be less than 1 second. Actually, in [8] the maximum number of iterations of the SA is set to 10.000 and the authors say that this limit has been chosen in order to guarantee that the SA procedure could reach its best possible solution (extra time would yield no improvement). However, it is not specified if this limit is reached or some other stopping criteria, such as stagnation behavior, was also used. Furthermore, no information is provided regarding the computing environment used for the experiments. For all these reasons we believe that there is a lack of information for doing a meaningful comparison of running times between our methods and the one in [8].

Table 1 summarizes the results. The computational time reported in table 1 is the time at which the best solution has been found. The total running time has been the same and limited by timeout for both variants of EM. It is worth noticing that our solution uses all the time allowed as its solution reaches the maximum duration c_0 , while the solution in [8] uses only 99% of it.

Table1: Comparison of reached results

	EM – V1	EM – V2	SA (J8)
Total route importance $g(r)$	157,4	157,4	154,4
Total route costs $c(r)$	100	100	99
Computational time [h:m:s]	1:40:22	0:05:28	unknown

Table 1 shows a substantial difference between EM variants V1 and V2 in computational time. As follows from the description of EM variants above, the only difference between the method variants is in the order of route inspections. This ordering strategy strongly influence the method efficacy depending on the configuration of the network topology and edge attributes. We have tested the both variants of EM on 5 other network instances with randomly generated edge attributes. In 3 cases the V1 was more effective, in one case the computational time was nearly the same and only in one case the V2 was more effective.

Table 2 summarizes the progress of feasible solutions for both variants of proposed exact method. The abbreviation NIR represents the Number of Inspected Routes. Computational time is in h:mm:ss format and represents the time at which a new incumbent solution is found. Solution process was interrupted after above mentioned time limit.

Table2: Comparison of EM solution progress

Feasible solution Nr.	EM – V1			EM – V2		
	Time	$g(r)$	NIR	Time	$g(r)$	NIR
1	0:00:01	110,2	1	< 1s	109,2	1
2	0:00:01	112,4	4	< 1s	112,0	2
3	0:00:01	120,8	115	< 1s	115,4	10
4	0:00:01	124,6	491	< 1s	119,6	11
5	0:00:03	128,4	1468	< 1s	120,6	39
6	0:00:03	129,6	1513	< 1s	120,8	61
7	0:00:05	133,0	2319	< 1s	122,8	81
8	0:00:06	134,4	2837	< 1s	123,4	118
9	0:00:06	137,6	2978	< 1s	129,0	150
10	0:00:07	139,2	3092	0:00:02	134,4	1175
11	0:00:07	140,4	3100	0:00:08	134,8	4331
12	0:00:07	141,6	3102	0:00:08	137,8	4337
13	0:00:07	145,2	3280	0:00:14	138,8	7604
14	0:16:04	145,6	494522	0:00:16	141,8	8256
15	0:16:04	146,8	494524	0:00:20	143,8	10207
16	1:35:08	147,8	3491448	0:00:20	147,8	10208
17	1:35:09	150,4	3492222	0:00:21	150,4	11030
18	1:35:11	151,4	3492858	0:00:23	151,4	11618
19	1:35:59	156,8	3517788	0:01:04	156,8	32727
20	1:40:22	157,4	3651982	0:05:28	157,4	167675

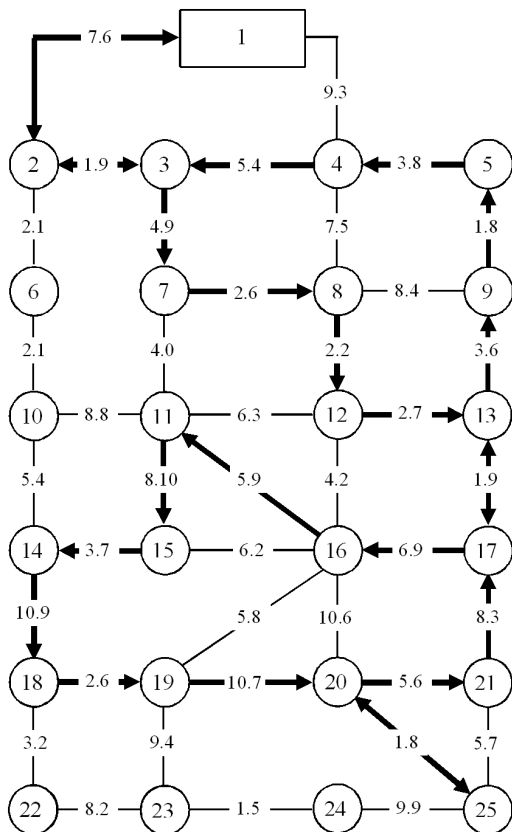

Figure 1: The best solution presented in [8]

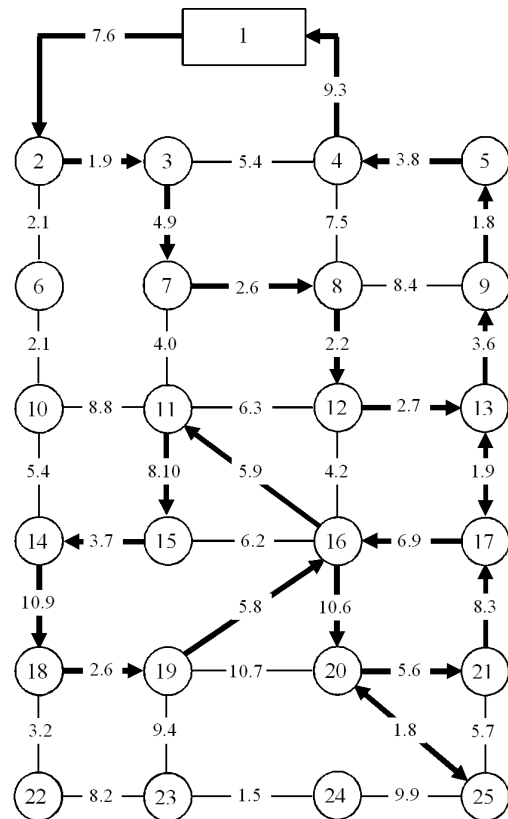

Figure 2: The best solution reached by EM

4 CONCLUSION AND OUTLINE OF FUTURE RESEARCH

This paper deals with a problem, denoted BP, of finding a circular service route in an undirected graph. The constraint requires that the “cost” of the resulting route does not exceed a given limit and the objective i.e. the total benefit of traversed edges is maximized. BP is characterized by the special feature that edges can be traversed several times, and each time they yield a (potentially different) contribution to the objective function.

Moreover, the relations of BP to other types of circular service routes is outlined and it is shown that, from the mathematical point of view, BP is a relaxation of the problem of designing optimal routes for cyclo-tourists. A combined exact-heuristic method, based on dept-first-search technique is proposed and the results are compared to those provided by Kuo et al. in [8]. The new method reached better solutions within a time that is reasonable for a design problem which is solved off line.

The future research will address the following issues:

- improving the convergence speed of the proposed method, for example by computing for each vertex u the minimum cost path to destination v , so that we can detect at an earlier stage that a given partial route from v to u can not return back to v within the limit c_0 ;
- enlarging the test bed to include other network instances;
- exploring the potentials of applying local search to the suboptimal solutions found by our method, yielding a hybrid math-heuristic approach, to be used to tackle larger instances;
- finding alternative MILP models, different from the one related to the problem in [5], which take advantage of the simpler structure of BP with respect to the problem in [5];

- studying how the method can be customized to a variety of practical applications, such as routing watering trucks equipped with a limited amount of water and due to clean streets with different priorities.

Acknowledgements: This work was supported by the Czech Science Foundation Grant No. P 402/12/2147, “*Economically Optimal Processes on Networks*“

References

- [1] Aráoz, J., Fernández, E. and Meza, O. (2007) Solving the Prize-collecting Rural Postman Problem. *Research Report DR-2007/12*, EIO Department, Technical University of Catalonia (Spain).
- [2] Benavent, Carrota, A., E., Corberán, Á. and Sanchis, J.M. (2007) ‘Lower bounds and heuristics for the Windy Rural Postman Problem’, *European Journal of Operational Research*, vol.176, pp. 855–869.
- [3] Benavent, E., Corberán, Á. and Sanchis, J.M. (2010) ‘A metaheuristic for the min–max windy rural postman problem with K vehicles’, *Computational Management Science*, Vol. 7, pp. 269-287.
- [4] Boland, N., Dethridge, J. and Dumitrescu, I. (2006) ‘Accelerated label setting algorithms for the elementary resource constrained shortest path problem’, *Operations research Letters*, vol. 34, pp. 58 – 68.
- [5] Černá, A., Černý, J., Malucelli, F., Nonato, M., Polena, L. and Giovannini, A. (2014) ‘Designing optimal routes for cyclo-tourists’, *Proceedings of The seventeenth Meeting of the EURO Working Group on Transportation (EWGT2014)*, Sevilla, Spain, July, 2nd to 4th 2014.
- [6] Fischetti, M., Salazar-Gonzalez, J.J., and Toth, P. (2007) ‘The generalized traveling salesman and orienteering problems’ in G. Gutin and A. P. Punnen, (Eds.) *The Traveling Salesman Problem and Its Variations*, Springer US, pp. 609-662.
- [7] Jerby, S. and Ceder, A. (2006) ‘Optimal routing design for shuttle bus service’, *Transportation Research Record* 1971, pp. 14–22.
- [8] Kuo, Y., Luo C.C. and Wang, C.C. (2013) ‘Bus route design with limited travel time’, *Transport*, vol. 28, pp. 368-373.
- [9] Pearn, W.L. and Wu T.C. (1995) ‘Algorithms for the rural postman problem’, *Computers & Operations Research*, vol. 22, pp. 819–828.
- [10] Vansteenwegen, P., Soffriau, W. and Van Oudheusden, D. (2011) ‘The orienteering problem: A survey’, *European Journal of Operational Research*, vol. 209, pp. 1 - 10.

Author’s address

Ing. Vladimír Příbyl, PhD. (corresponding author)
 University of Economics in Prague, Faculty of Management, Department of Exact Methods.
 Jarošovská 1117/II, 377 01 Jindřichův Hradec
 Czech Republic
 email: pribyl@fm.vse.cz

MINIMALISTIC SIMULATION OF POPULATION AGING'S IMPLICATIONS IN THE SLOVAK REPUBLIC

*Zdeněk Rosenberg,
Masaryk University, Brno*

Abstract

The main goal of the paper is to present transparent simulation of population's aging fiscal implications in the Slovak republic. The simulation uses projection of population aging and briefly analyses some of its aspects. It uses the number of people of each age and average government's expenditures related to citizen of every year of age to calculate total expenditures for every year from present till 2050. The needed level of productivity of labor growth sufficient to balance budget in long run is calculated.

Keywords: Aging, Pension system, Fiscal policy, Labor productivity, Simulation

JEL Classification: C63, H55, H68

AMS Classification: 68U20

1 INTRODUCTION

This paper presents a simulation of the budget implications of population aging in the Slovak Republic using author's own approach. In contrast to usual overlapping generation model (OLG)¹ this approach is simpler and very transparent. For the purpose of the simulation a population projection by The World Bank is used along with fiscal indicators from recent years. The core of this simulation is simple vector product. For every year of the simulation the government's simplified age related expenditures are calculated using the number of citizens of each age group and the age related expenditures of average citizen of that specific age cohort which is five years long. The simulation shows the total expenditures of every fifth year under the assumption that the structure of expenditures will stay the same as it was in the year 2010 which is a starting year of the simulation.

2 POPULATION PROJECTION AND DATA

Figure 1 shows a sharp drop of the percentage share of 16-65 years old. The minimum of 58.7% is reached only at the end of the simulation. The oldest age group's share is at its maximum of 26.4% at that moment. From 2030 on over half of those older than 20 will be also older than 50, whilst it is 40.5% in 2010. The majority of those over 20 will be over 55 in 2050 whilst it is 31.2% in 2010. This fact may worth noting because it is very likely to shift the preferences of median voter.

¹ For the explanation of the OLG approach, precise description of all used parameters and equations see Babecký, Dybczak (2009).

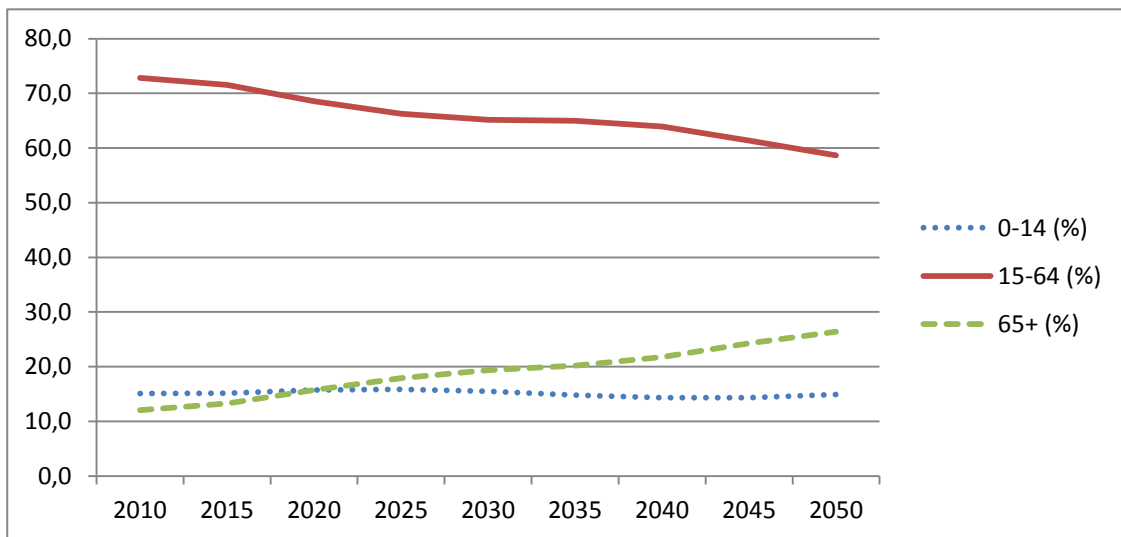

FIGURE 1: **Projections of Slovak republic's main age groups share of population**
Source: World Bank.

In Figure 2 the slow declining trend of Slovak population is apparent. In contrast to this the rising number of those over 65 is shown along with the estimated number of employed population. This estimate was calculated by using the employment rates for age groups of five years from pre-crisis year 2008 as provided by Eurostat in [2] combined with the number of people in each age group from the projection.

The simulation uses the government's expenditures related to the average citizen of every age group as is shown in Figure 3. All prices are in current Euros. There is no inflation in the simulation so when pensions do not change in time they are actually inflation adjusted. Expenditures consist of costs of every level of education as provided by World Bank in [8], unemployment costs and pensions. Average unemployment monthly benefit of 307 Euro and average monthly state pension of 399 Euro are used.² The enrollment rate of secondary education is currently 92% of the population and for tertiary education it is 52% as provided by World Bank. The five years of primary, eight years of secondary and three years of tertiary education are used in the simulation to compensate for those who drop out.

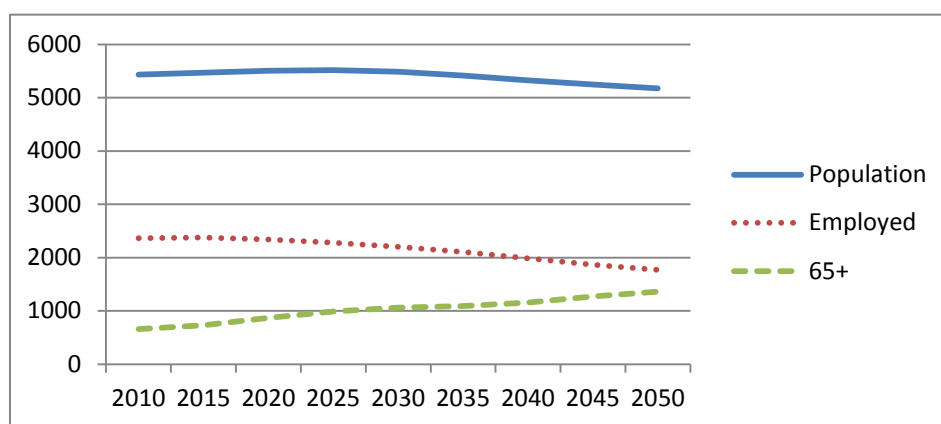

FIGURE 2: **Total population, number of employed and those over 65 (in thousands)**
Source: World Bank, Eurostat, author's calculations.

² The number 307 is average of values from years 2011, 2012 and 2013 and the 399 is average pension as calculated in February 2014 by Sociálna poisťovňa in [6] and [7]. This slightly higher numbers are used deliberately because pensions and unemployment benefit do not rise in the simulation even when the productivity of labor does.

Education cost, unemployment and state pensions of average citizen are shown in Figure 3. Unemployment is distributed to age groups using data form 2008 so the simulation's results are not disturbed by the current crisis.

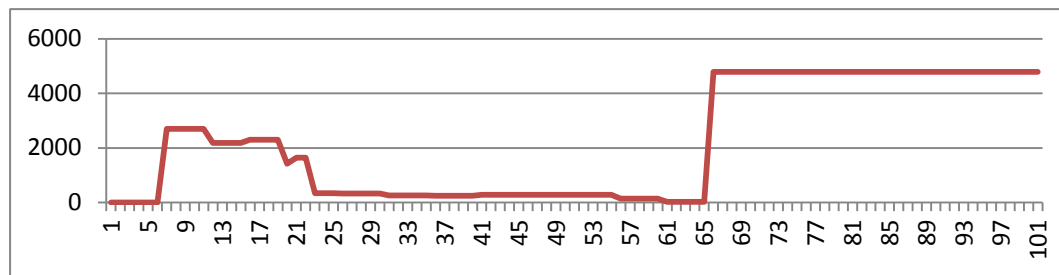

FIGURE 3: Age related expenditures per citizen (in Euros)

Source: International Labour Organization, Sociálna Poist'ovňa, World Bank.

3 RESULTS

The rise in state pensions caused by population aging cannot be compensated by lower public spending on education as is clear form Figure 4.

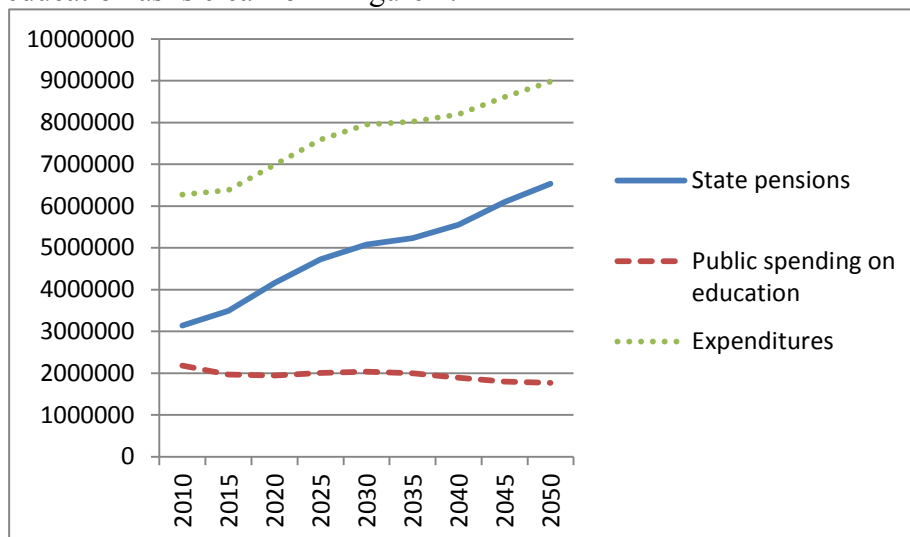

FIGURE 4: Selected expenditures (in thousands of Euros)

Source: World Bank, Eurostat, author's calculations.

Slovak Republic relies heavily on indirect taxation and so calculating the effect of aging on overall finances directly would require a detailed enquiry into the source of money paid on indirect taxes another approach was needed. The balanced budget of the government's age related revenues and expenditures have been chosen as a starting point for the simulation. Using the number of employed citizens and total age related expenditures it was calculated that to achieve balanced budget in 2010 average employed citizen must have paid 2651 Euro.³ This allows the simulation to answer two key questions. What would the deficit be if nothing happened to ease the impact of aging and how much more must employed citizens pay to achieve balanced budget in the long run.

The deficits were calculated using total age related expenditures and the assumption that employed citizens would have to pay the same taxes as in the beginning of the simulation for the rest of it. As is clear from the Figure 5 the deficits will grow steeply and reach as high as 6.5% GDP. This is for the situation with no growth and it is equal to 33.2% of the whole government

³ This is much more than 887 Euro form the income taxation and capital gains on one employed as is the current situation as provided by Ministry of finance of the Slovak republic.

revenues from starting year. The cumulated deficit from every year of the simulation would reach 122.5% GDP. Using the age related expenditures, number of employed population and the taxation needed to balance this part of budget it was calculated that the growth in productivity of labor of 1.64% a year would be sufficient to balance budget at the most problematic end of period.

Because of the much shorter simulation period and different role of direct taxation which led to new method of establishing the deficit in this paper it is not possible to make direct comparison to the results obtained by similar simulation in Rosenberg (2014). In that study Czech economy was analyzed for the period of 2013 to 2100 and much higher deficit of 11.6 % GDP in the worst year 2060 was found. Also the accumulated deficit was much higher but the growth of productivity sufficient for balanced budget was below one percent a year.

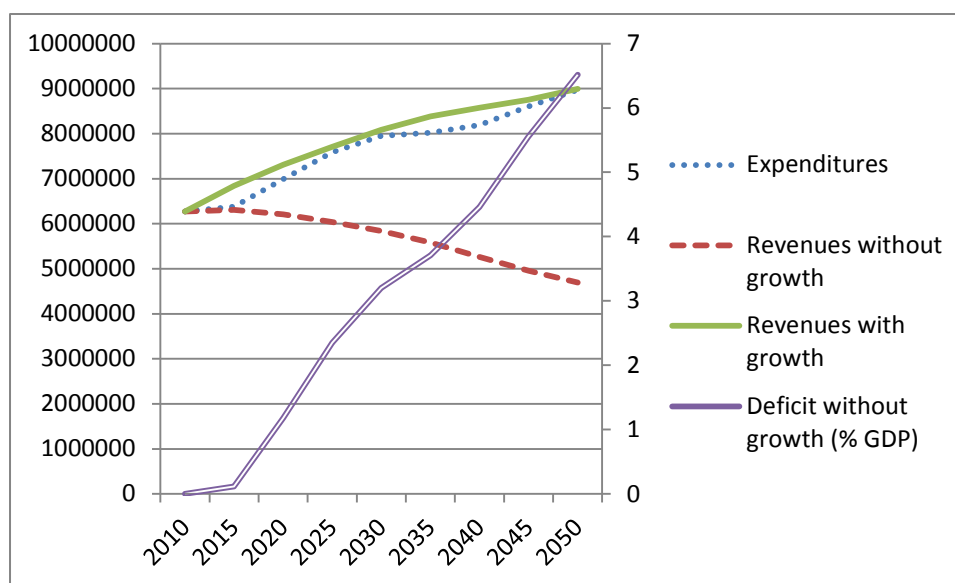

FIGURE 5: Deficits and revenues (in thousands of Euros)

Source: Author's calculations.

4 CONCLUSIONS

The goal of the simulation was to provide an insight into the dynamics of what is likely to happen and not to provide exact numbers

- The deficit of state pensions accumulated over a whole period is over 120% GDP and is still growing. Labor productivity and economic growth are a top priority in dealing with an aging population. With its second pillar of the pension system, which is mandatory since 2005, and the popularity of the growth fund the Slovaks are clearly expecting favorable levels of growth.
- Even modest growth of productivity of labor of 1.64% a year can make the current system sustainable.
- Even though the absolute income of the seniors would not drop with the growth mentioned above, the relative would drop dramatically if it was not for the successful second pillar. Further analysis of the larger economic growth's impact on the possibility of rising state pensions is needed.

Acknowledgements: This work was supported by Specific research project at ESF MU.

References

- [1] Babecký, J. and Dybczak, K.: (2009) *The Impact of Population Ageing of the Czech Economy (working paper ČNB)*, [Online], Available: https://www.cnb.cz/miranda2/export/sites/www.cnb.cz/en/research/research_publications/cnb_wp/download/cnbwp_2009_01.pdf.
- [2] Eurostat, *Employment rates by sex, age and nationality*, [Online], Available: http://appsso.eurostat.ec.europa.eu/nui/show.do?dataset=lfsa_ergan&lang=en.
- [3] International Labour Organization, *Unemployment 3B*, [Online] Available: <http://laborsta.ilo.org/STP/guest>.
- [4] Ministry of finance of the Slovak republic, *Public Administration Budget*, [Online], Available: <http://www.finance.gov.sk/Default.aspx?CatID=6958>.
- [5] Rosenberg, Z. (2014) 'Minimalistic Simulation of Population's Aging Fiscal Implications and the Role of Productivity of Labor', *Pavel Jedlička. Hradec Economic Days 2014. 1. vyd.*, Hradec Králové: Gaudeamus, pp. 256-262, 7 p., ISBN 978-80-7435-370-3.
- [6] Sociálna poisťovňa. *Priemerná výška dávky v nezamestnanosti*, [Online], Available: <http://www.socpoist.sk/priemerna-vyska-davky-v-nezamestnanosti/1663s>.
- [7] Sociálna poisťovňa. *Priemerná výška vyplácaných dôchodkov (v mesiacoch)*, [Online], Available: <http://www.socpoist.sk/646/1614s>
- [8] World Bank. *Country statistic. Slovak republic*, [Online], Available: <http://data.worldbank.org/country/slovak-republic>
- [9] World Bank. *Population projection*, [Online], Available: http://siteresources.worldbank.org/EXTHNPSTATS/Resources/3237117-1319036514658/SVK_POP.XLS

Author's address

Ing. Zdeněk Rosenberg

Faculty of Economics and Administration, Department of Economics, Masaryk University

Lipová 41a 602 00, Brno Czech Republic

email: zdenek.rosenberg@econ.muni.cz

MODELING TRENDS AND CYCLES OF GDP IN SLOVAKIA

Eva Rublíková,
University of Economics in Bratislava

Abstract

To study the growth and cyclical behaviour of GDP in Slovakia we have been faced with the problem of separating cyclical fluctuation from long-term movements. The difficulties have been risen from the definition of alternative trend models, which could produce different cyclical components. Similar problem was solved in This problem has been Our analysis has been done on seasonally adjusted quarterly data of GDP c.p. in Slovakia, during the period Q1/1995 till Q3/2013. We shall use classical techniques of modeling trend together with autoregressive models of modeling cycle in time series of GDP.

Keywords: Linear trend, Moving averages, Autoregressive model

JEL Classification: C22

AMS Classification: 91B84

1 MACROECONOMIC SERIES WITH TREND AND CYCLE

Modelling trends and cycles in time series has a long history in empirical economics. Statistical analysis of secular movements used to be described by moving averages (simple or weighted) or by the the various analytical function of time. The cycles are described by goniometric functions or by autoregressive models. Time series with trend, cycle and randomness is usually analysed by the decomposition method. The question is, whether various methods of detrending time series be able to influence selection of the cycle model or lengths of cycle. This problem was published in [7] and its idea was proved in [5] and [6], where the authors showed that various models of trend would influence the length of cycle of quarterly real GDP in V4 countries. Our analysis is more specific, focused on seasonally adjusted quarterly data of GDP (c.p.) in Slovakia, during the period Q1/1995 till Q3/2013. The aim of the presentation is to show, how to compute the length of cycle, when the trend of the series is loglinear and the cycle is given by autoregressive models of order p .

1.1. Trend component

For classical trend-cycle decomposition is typically that time series, y_t , observed over the period $t = 1, 2, \dots, T$ is decomposed additively into a trend, μ_t , and a cyclical component, ε_t , which are assumed to be statistically independent of each other, i.e.

$$y_t = \mu_t + \varepsilon_t, \quad E(\mu_t, \varepsilon_s) = 0 \text{ for all } t, s \quad (1)$$

In the model, y_t is the logarithm of the series which are usually observed annually, or quarterly (monthly) but seasonally adjusted.

The simplest model for μ_t is the linear trend, written in the form

$$y_t = \beta_0 + \beta_1 t + \varepsilon_t \quad (2)$$

Because y_t is measured in logarithms, β_1 assumes annual or quarterly constant growth. Regression coefficients could be estimated by ordinary least squares and the cyclical component is then obtained by residuals as

$$\hat{\varepsilon}_t = y_t - \hat{\mu}_t = y_t - \hat{\beta}_0 - \hat{\beta}_1 t. \quad (3)$$

If cycles are, in fact, present in the data, ε_t are autocorrelated, and this autocorrelation would be expressed by, for example, AR(p)- autoregressive model of order p . [6]

Combining model of the loglinear trend and autoregressive model of order p gives the model, in which parameters needs to be estimated by means of nonlinear least squares.

1.2 The cyclical component

In the previous section nothing was explicitly stated about the properties of the trend and cyclical components. We took immediately linear trend but in general we used to regard that μ_t is an any smooth function designed to capture the long-run secular or growth component of y_t . Then the implicit view of the cyclical component ε_t is, that departures of y_t from μ_t must be only temporary, assuming that ε_t is stationary. According definition, stationarity requires that the mean of ε_t must be constant, which may be taken as zero here, the variance must be constant and finite, and covariances between ε_t and ε_{t+k} must depend only on the time shift k :

$$E(\varepsilon_t) = 0 \quad E(\varepsilon_t^2) = \sigma_\varepsilon^2 < \infty \quad \gamma_k = E(\varepsilon_t \varepsilon_{t-k}) \text{ for all } t \text{ and } k \neq 0. \quad (4)$$

By Wold's decomposition theorem [6] stationary time series would be expressed by the linear filter representation

$$\varepsilon_t = u_t + \psi_1 u_{t-1} + \psi_2 u_{t-2} + \dots = \sum_{j=0}^{\infty} \psi_j u_{t-j}, \quad \psi_0 = 1 \quad (5)$$

where u_t for $t = 0, \pm 1, \pm 2, \dots$, is a white noise with the properties: u_t are a sequence of men zero, constant variance σ_u^2 , i.i.d. random variables, so that $E(u_t, u_{t+k}) = 0$, for all $k \neq 0$. Stationarity requires that ψ -weights in the linear filter representation (5) are absolutely summable, in which case ψ -weights are said to convergate.

Many realistic models for the cyclical component result from particular choices of the ψ -weights, especially if $\psi_j = \phi^j$ the lienar proces (5) could be rewritten as first-order autoregressive model AR(1).

$$\varepsilon_t = u_t + \phi u_{t-1} + \phi^2 u_{t-2} + \dots = u_t + \phi \varepsilon_{t-1},$$

or

$$\varepsilon_t - \phi \varepsilon_{t-1} = u_t$$

Because AR(1) model could not capture cycle, the higher order have to be taken. Using back shift operator $B^p \varepsilon_t = \varepsilon_{t-p}$ we can express autoregressive model of order 2 in the form

$$\varepsilon_t = \phi_1 \varepsilon_{t-1} + \phi_2 \varepsilon_{t-2} + u_t$$

or as

$$(1 - \phi_1 B - \phi_2 B^2) \varepsilon_t = (1 - g_1 B)(1 - g_2 B) \varepsilon_t = u_t \quad (6)$$

where the roots g_1 and g_2 of the associated characteristic equation $\phi_2(B) = 0$ are given by

$$g_1, g_2 = \{ \phi_1 \pm (\phi_1^2 + 4\phi_2)^{1/2} \} / 2 \quad (7)$$

For stationarity, it is required that the roots be such that in absolute values are less then 1, or coefficients of AR(2) need to follow set of restrictions $\phi_1 + \phi_2 < 1$, $\phi_2 - \phi_1 < 1$, $-1 < \phi_2 < 1$ and u_t are independently and identically distributed .

The roots can both be real or they can be a pair of complex numbers, which would produce an autocorrelation function (ACF) following a damped sine wave and hence an ε_t containing cyclical fluctuations. When the roots are complex they take the form $d \exp(\pm 2\pi fi)$, whereupon the ACF becomes the damped sine wave

$$\rho_k = \frac{(\text{sgn}(\phi_1))^k d^k \sin(2\pi fk + F)}{\sin F} \quad (8)$$

$d = \sqrt{-\phi_2}$ is damping factor and f and F are the frequency and phase of the wave, these being obtained from

$$f = \frac{\cos^{-1}(|\phi_1|/2d)}{2\pi} \quad (8a)$$

and

$$F = \tan^{-1}\left(\frac{1+d^2}{1-d^2} \tan 2\pi f\right) \quad (8b)$$

respectively. Period of the cycle is then defined as $1/f$.

Higher order AR models will exhibit cyclical fluctuations as long as they admit a pair of complex roots, i.e., if an $AR(p)$ model can be factorised as

$$\phi_p(B)\varepsilon_t = (1 - d \exp(2\pi fi)B)(1 - d \exp(-2\pi fi)B) \prod_{j=3}^p (1 - g_j B)\varepsilon_t = u_t \quad (9)$$

1.3 Application to the quarterly GDP data seasonally adjusted

We would like to apply the described method on quarterly data of GDP (in c.p), seasonally adjusted, from the period Q1/1995 till Q3/2013. The data are taken from Slovstat database.

Development of GDP seasonally adjusted in SR is pictured on Figure 1 together with linear trend estimation for logarithmic transformation of GDPsadj.

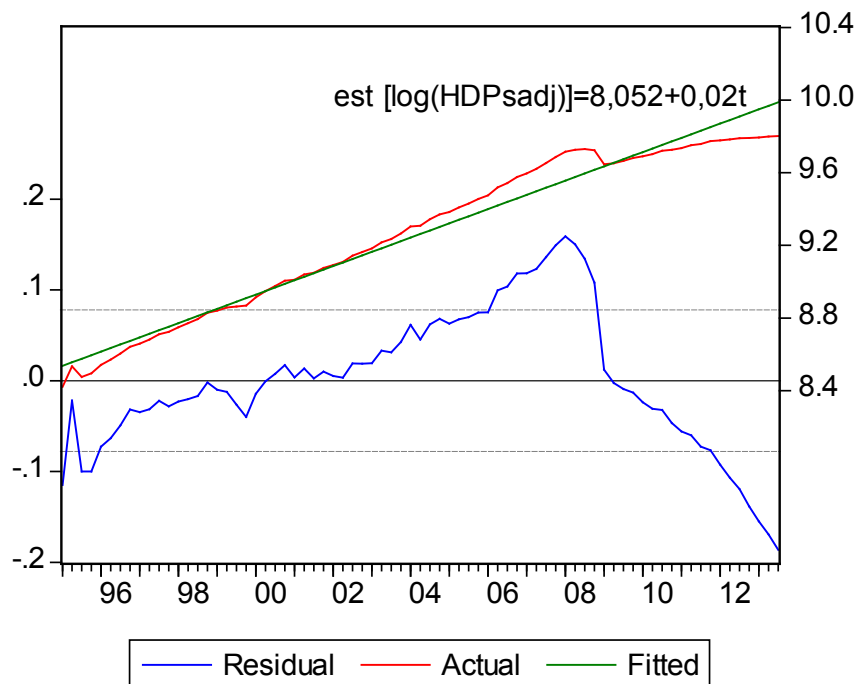

Figure 1 Series and the loglinear trend for GDPsadj

Source: Slovstat and own computations

The loglinear trend gives $R^2 = 0,9682$ with positively correlated residuals, $DW = 0,08$. From the analysis of ACF and PACF of loglinear trend residuals we stated, that $AR(4)$ could be appropriate as it is possible to see from the output in Table 1.

Table 1 Estimation of the cycle in residuals of loglinear trend of GDP sadj

Dependent Variable: CYCLEHDP

Method: Least Squares

Date: 03/14/14 Time: 17:43

Sample (adjusted): 1996Q1 2013Q3

Included observations: 71 after adjustments

Convergence achieved after 3 iterations

Variable	Coefficient	Std. Error	t-Statistic	Prob.
AR(1)	1.171630	0.049278	23.77571	0.0000
AR(4)	-0.202890	0.052682	-3.851229	0.0003
R-squared	0.961036	Mean dependent var		0.004738
Adjusted R-squared	0.960471	S.D. dependent var		0.076449
S.E. of regression	0.015200	Akaike info criterion		-5.507336
Sum squared resid	0.015941	Schwarz criterion		-5.443599
Log likelihood	197.5104	Durbin-Watson stat		1.678077
Inverted AR Roots	.88-.05i	.88+.05i	-.29-.42i	-.29+.42i

Source: Own computation

The $AR(4)$ model may be factorised as the pair of quadratics $(1 - 1,76B + 0,7994B^2)$ and $(1 + 0,58B + 0,2605B^2)$. These admit two pairs of complex roots. The first pair provides a cycle with a period 35,7 quarters (about 9 years) with dumping factor 0,864. The second pair of complex roots provides the second cycle with the period 6,5 quarters (one and half year) with dumping factor 0,51.

We also took the Henderson weighted moving average of order 5 to fit a trend component to find out whether it could influence the estimation of the length of the cycle. The choice was good, and we did not find any differences, when the decomposition method of the time series was assumed.

2 CONCLUSION

The time series of GDP seasonally adjusted in SR during the period Q1/1985 till Q3 2013 were described by the logarithmic linear trend and residuals series were described by the autoregressive model of order 4. We have found out that there are 2 cycles: the first one of the about lengths 9 years with dumping factor 0, 864 and the second one with the period one and half year and dumping factor of 0,51.

Acknowledgements: This work was supported by VEGA č. 2/0160/13 *Finance stability and sustainability of economic growth in Slovakia in conditions of global economy* and by VEGA č.1 /0285/14 *Regional modelling of the economic growth of EU countries with concentration on spatial econometric methods*.

References

- [1] Hančlová, J. et al. (2010) *Makroekonomické modelování české ekonomiky a vybraných ekonomik EU*. VŠE-TU, Ostrava.
- [2] Harvey, A. C. (1985) 'Trends and cycles in macroeconomic time series', *Journal of Business and Economic Statistics*, vol. 3, pp. 216-227.
- [3] Ivaničová, Z., Chocholatá, M. and Surmanová, K. (2012) *Ekonomické modelovanie*, Bratislava: Vydavateľstvo EKONÓM.
- [4] Lukáčik, M. and Szomolányi, K. (2011) 'Možnosti analýzy hospodárskych cyklov', *Forum Statisticum Slovacum*, vol. 7, pp. 148-153.
- [5] Lukáčik, M. and Szomolányi, K. (2011) 'Modelovanie trendov a cyklov v krajinách V4', *Nové trendy v ekonometrii a operačným výzkumu – Conference Proceedings*, The Seminar of Department of Econometrics in Prague and Department of Operations Research and Econometrics in Bratislava, Prague.
- [6] Mills, T. C. (1990) *Time series techniques for economists*, New York: Cambridge University Press.
- [7] Mills, T. C. (2003) *Modelling Trends and Cycles in Economic Time Series*, New York: Palgrave Macmillan.

Author's address

prof. RNDr. Eva Rublíková, PhD.

University of Economics in Bratislava, Faculty of business informatics, Department of Statistics
Dolnozemska 1/b, 852 35 Bratislava

Slovak Republic

email: rublik@euba.sk

IMPACT OF MINIMUM WAGE DYNAMICS ON UNEMPLOYMENT: AN EMPIRICAL APPROACH

*Jaroslav Schulz, Štěpán Mikula,
Masaryk University, Brno*

Abstract

This paper deals with the impact of minimum wage dynamics on the unemployment rate. We provide an empirical analysis of unbalanced panel of 24 countries in the period of 1985-2009 based on a broad data set from OECD and Penn World Tables (v8.0) databases. The effect of minimum wage is controlled for influence of business-cycle as well as labor markets' institutional setting and unemployment benefits. Our results indicate that the significance of the effect found depends on the measure used. The real minimum wage growth rate has a positive and significant effect on unemployment rate but the estimates obtained for median-based measures of minimum wage are insignificant. Despite the statistical significance the economic effect found is very limited. Presented results stress the need for a deeper understanding of the distortions caused by the minimum wage.

Keywords: *minimum wage, dynamics, unemployment, institutions, wage policy*

JEL Classification: E24, E02

AMS Classification: 91B40

1 INTRODUCTION

The effect of minimum wages on employment and hence economic effects has been the most prominent topic in past few decades for researchers as well as for wage policy makers. The final effect is definitely ambiguous. Particular findings significantly vary over the research period.¹ Various literature could generally be split into two basic categories. One that derives negative impact of minimum wages on employment and the other allowing zero or positive effect of minimum wages on employment.

The first category, and in spite of its simplicity very strong, is based on static neoclassical approach. The findings are derived, in its pure version, within a partial equilibrium approach or more sophisticatedly, within general equilibrium approach (Walrasian model). No matter of applied method, introducing the minimum wage has always a negative impact on employment in neoclassical static approach (Neumark & Wascher, 1991; Bazen & Skourias, 1997).

The second set of research literature responds to the drawbacks of neoclassical approach which has been much criticized and led to alternative static models, often designated as “new minimum wage research”. These models admit zero or even positive effect of minimum wages on employment depending on the height of the minimum wage and elasticity of the factor and good demand curves, such as two-sector models or monopsony labor market models (Machin & Manning, 1993; Card & Krueger, 1995; Dickens et al., 1999). The latter introduced by Stigler (1945) in combination with the theory of efficiency wages (Shapiro & Stiglitz 1984) has been a real boost in further research.

Although there has not been much implementation of minimum wages to dynamic approach, the few of them brought important and “unexpected” results. Introducing minimum wages into endogenous growth models unlike to static approach does not have negative effect on employment. Furthermore, the models show full-employment in steady state growth and hence the minimum wage has no impact in long term, however in short term the unemployment still

¹ Well-arranged research evolution of the minimum wage effects on employment is published for instance in Neumark, Wascher (2007).

exists. Moreover, some of the model settings even prove higher growth rates when implementing minimum wages.

Empirical analyses of the employment effects of minimum wages differ in methodology in particular studies employing time-series analysis, using pooled cross-sectional or longitudinal data or comparing the level of employment before and after minimum wage increase (“differences in differences”).

Most of the papers inspecting unemployment take into account impacts of business cycle and delay between the responses of real economy and the changes. But not all of them also consider the role of institutions. The term “*institutions*” covers broad set of rules, informal habits and regulations, which shape the functioning of the labor markets. The institutions influence the willingness of households to supply labor as well as the willingness of the firms to hire workers. The most flagrant example is the social security system setting and legal employment protection. Higher unemployment benefits increase opportunity costs of being employed and prolongs the job searching, therefore increases unemployment. Legal employment protection influences the demand. More strict protection slows down the natural fluctuation of labor force among jobs. Higher protection therefore slows adaptation of the labor markets to shocks which results in higher unemployment as well. The “*adverse institutions*” is sometimes used as a synonym of the “*labor market rigidity*” (e.g. see Blanchard & Wolfers, 2000).

The minimum wage itself can be understood as an institution – the rule legally imposed by the state. Generally, minimum wages are set by law, government or in assorted types of bargaining. Involving all types of minimum wages process into single model influences the model outcomes in negative manner. The intuition behind is that the minimum wage set by bargaining is considered in modern approach to be near the equilibrium (binding wage) and hence there is almost no effect of minimum wage on unemployment.

On the contrary, it is not very often just one minimum wage set by government but rather a ladder of minimum wages that differ for work categories. Aggregate level data however do not take into account the set of the minimum wages but the lowest value. This approach omits huge variety of effects (cross section, vertical adjustments, etc.), as the minimum wage changes are typically asymmetric in the minimum wages set. Related problem is the law enforcement and a potential threat of a penalty when the employers do not adjust the wages.

The key determinant influencing the eventual effect of minimum wage change is then the wage distribution, in other words, what part of working population is directly affected by the change of the minimum wage and in what way. The change of minimum wage may cause four types of effects on the wage distribution (for empirical researches see e.g. Neumark et al., 2004 or DiNardo et al., 1995):

- a) The workers who would be now below the minimum wage would leave the labor market – i.e. the minimum wage would cut off the lower tail of the wage distribution (and vice versa). It would cause shift in the mean wage as well as in median wage.
- b) The workers who would be now below the minimum wage would get minimum wage. It would yet again shift the mean wage, however the median wage would remain unchanged (if and only if the minimum wage is less than or equal to the median wage – which probably holds).
- c) The change of minimum wage will shift the whole distribution. It might be caused for example by the setting of minimum wage which can be (formally or informally) the function of the wage distribution's central tendency. Such change will increase the median as well as the mean, however the ratio of minimum and mean/median wage will remain unchanged.
- d) The change of minimum wage can, of course, have no effect. The minimum wage can be set below the equilibrium price or the only effect of the change might be spillovers of the workforce between legal and shadow economy. Neither of them will cause any change in the wage distribution.

Minimum wage affects primarily the lower tail of the wage distribution, therefore the substantial amount of empirical papers aims just on the lowest paid workers. Unfortunately, sufficiently detailed data on low-paid workers are not available at international level. Using simplified aggregate data, which omit country and wage-level specific effects, leads to very general conclusions that might not correspond to reality. Therefore, all results obtained from aggregated data, including ours, have to be interpreted with caution.

This paper focuses primarily on the effects of the minimum wage on unemployment dynamics. We use set of minimum wage indicators in order to distinguish between its potential bias (or its incapability to capture important effects of minimum wage) and true effect of minimum wage.

The structure of the paper is as follows. In next chapter, we introduce the model, define the variables as well as the economic background. Further section is dedicated to the results for various model settings. Last section briefly presents the conclusions of our work and identifies potential extensions for further research.

2 MODEL AND DATA

The goal of this paper is to investigate the possible relationship between unemployment rate dynamics and minimum wage. The research is performed by using the annual unbalanced panel of OECD countries² in period of 1985-2009. The data frequency used is given by data availability (especially data on minimum wage).

The unemployment dynamics is described by first differences of unemployment rate in country i and time j ($\Delta u_{i,j}$). We use annual harmonized unemployment rate published by OECD. The dynamics is explained by the following model:

$$\Delta u_{i,j} = \beta_0 + \beta_1 g_{i,j} + \beta_2 g_{i,j-1} + \beta_3 institutions_{i,j} + \Delta benefits_{i,j-1} + \beta_6 wage_{i,j} + \varepsilon_{i,j} \quad (1)$$

where $g_{i,j}$ represents GDP per capita growth rate, $g_{i,j-1}$ lagged GDP per capita growth rate, $institutions_{i,j}$ the strictness of employment protection, $\Delta benefits_{i,j-1}$ the difference of the share of unemployment benefits on GDP and $wage_{i,j}$ represents minimum wage

The effect of minimum wage is controlled for the influence of the business cycle, labor market rigidity and unemployment benefits which alter the motivation to work.

The business cycle is described by the variable g which depicts the growth rate of real GDP per capita. (Data on GDP per capita come from the Penn World Tables v8.0.) The expected effect of the growth rate is, in accordance with Okun's law, negative.

The institutional setting is approximated by the first version of OECD's Strictness of employment protection index. Higher values of the index indicate more rigid labor market. This variable is the only one which reflects the state instead of change. It reflects the role of institutions in the labor market. Rigidities influence the way business-cycle as well as other shocks translate into unemployment. Moreover, the institutions are extremely stable in time. Higher rigidity should be therefore accompanied by higher increases in unemployment rate.

The last control variable is change (first differences) in the share of unemployment benefits on the GDP. We assume that increase in unemployment benefits decreases the motivation to work and therefore raises the unemployment.

The last explanatory variable in the model is the minimum wage. Data on minimum wage are available in three forms: size of the minimum wage in currency, minimum wage as a share of median wage and minimum wage as a share of average wage. The unemployment dynamics should depend on the changes of minimum wage, which can be described by using measures mentioned above. Selection of the proper measure depends on the kind of wage distribution distortion caused by the minimum wage. Possible (and not exclusively valid) distortion given above indicates, that all available measures might provide biased or at least blurry picture of the

²Panel contains data on Australia, Belgium, Canada, Czech Republic, Spain, Estonia, France, United Kingdom, Greece, Hungary, Chile, Ireland, Israel, Japan, Korea, Luxemburg, Netherlands, New Zealand, Poland, Portugal, Slovakia, Slovenia, Turkey and the United States.

effects of the minimum wage. The change of real minimum wage might be irrelevant with respect to unemployment if c) holds. Measures using share of mean/median wage would provide unclear interpretation in the case of a). However, the share of median seems to be better choice when it is reasonable to assume that it is immune to b).

And of course if d) holds, then the minimum would have no effect at all – which should be identified by the model estimation. Therefore, we use three measures of minimum wage changes:

- Real minimum wage growth rate ($r.wage_{i,j}^{growth}$),
- Growth rate of minimum wage share on median wage ($m.wage_{i,j}^{growth}$),
- Difference of minimum wage share on median wage ($m.wage_{i,j}^{diff}$).

Measures based on the share on median wage are strongly correlated (Pearson's r is equal to 0.975*** and Spearman's r_s is 0.994***; see Table 2). All data on minimum wage come from the OECD database.

The model is estimated with fixed country and time effects. A robust covariance matrix is estimated by method originally suggested by Arellano (1987). We estimate the parameters for four samples of countries:

- Sample A contains all available data
- Sample B covers countries with time-series longer than 10 observations. Required number of observations is set arbitrarily, however the results are robust with respect to its minor changes.
- Sample C consists of the countries of the former Eastern block. These labor markets might exhibit specific behavior in the period of interest due to ongoing transition.
- Sample D contains countries which meet condition of sample B and simultaneously are not covered in sample C (i.e. countries with more than 10 observations which was not part of the Eastern block.)

The items of all samples are listed in Table 1.

The summary statistics for variables used are presented in Table 3, estimated parameters (without fixed effects) in Table 1 and Spearman's rank correlation coefficient are in Table 2.

Table 1: Regression results (dependent variable: first difference of unemployment rate)

sample	A	B	C	D	A	B	C	D	A	B	C	D
$g_{i,j}$	-0.129*** (0.031)	-0.156*** (0.035)	-0.176** (0.067)	-0.106*** (0.032)	-0.125*** (0.031)	-0.149*** (0.035)	-0.185*** (0.046)	-0.105*** (0.033)	-0.125*** (0.031)	-0.150*** (0.035)	-0.184*** (0.046)	-0.105*** (0.032)
$g_{i,j-1}$	-0.114*** (0.024)	-0.091*** (0.024)	-0.078 (0.078)	-0.083*** (0.027)	-0.117*** (0.024)	-0.096*** (0.025)	-0.095 (0.063)	-0.090*** (0.025)	-0.117*** (0.024)	-0.096*** (0.024)	-0.093 (0.063)	-0.089*** (0.025)
$institutions_{i,j}$	0.335** (0.136)	0.340*** (0.127)	1.783 (1.877)	0.202 (0.173)	0.361*** (0.137)	0.380*** (0.128)	1.929 (2.045)	0.244* (0.128)	0.360*** (0.138)	0.380*** (0.129)	1.762 (2.069)	0.244* (0.127)
$\Delta benefits_{i,j}$	1.635*** (0.538)	1.367** (0.592)	18.876*** (4.831)	1.182*** (0.429)	1.639*** (0.527)	1.410** (0.613)	21.044*** (5.369)	1.293*** (0.447)	1.636*** (0.521)	1.410** (0.611)	20.476*** (5.251)	1.291*** (0.447)
$\Delta benefits_{i,j-1}$	1.358*** (0.490)	1.485*** (0.506)	-9.608 (9.652)	1.670*** (0.537)	1.405*** (0.517)	1.493*** (0.527)	-9.810 (8.968)	1.585*** (0.535)	1.410*** (0.524)	1.493*** (0.527)	-9.703 (9.237)	1.586*** (0.533)
$r.wage_{i,j}^{growth}$	0.016** (0.007)	0.025*** (0.007)	-0.024 (0.032)	0.048*** (0.016)								
$m.wage_{i,j}^{growth}$					-0.288 (1.253)	0.064 (1.559)	-3.818* (2.143)	-1.935 (3.298)				
$m.wage_{i,j}^{diff}$									-0.716 (2.576)	0.169 (3.484)	-8.223 (5.503)	-3.300 (7.044)
Observations	337	306	51	259	336	306	51	259	336	306	51	259
R 2	0.597	0.573	0.690	0.643	0.594	0.566	0.700	0.635	0.594	0.566	0.697	0.635
Adjusted R 2	0.501	0.487	0.365	0.539	0.500	0.481	0.371	0.532	0.501	0.481	0.369	0.532
F Statistic (degreesoffreedom)	13.954*** (30; 283)	11.633*** (30; 260)	3.336*** (18; 27)	13.049*** (30; 217)	13.814*** (30; 283)	11.321*** (30; 260)	3.507*** (18; 27)	12.608*** (30; 217)	13.815*** (30; 283)	11.321*** (30; 260)	3.449*** (18; 27)	12.572*** (30; 217)

Samples: A – All countries; B – All countries with more than 10 observations (Australia, Belgium, Canada, Czech Republic, Spain, France, Greece, Hungary, Japan, Korea, Netherlands, New Zealand, Portugal, Poland, Slovakia, United States); C – Countries of the former Eastern block (Czech Republic, Estonia, Hungary, Poland, Slovakia, Slovenia) – **data for the countries in the sample C are available only for the period of 1997–2009**; D – Countries with more than 10 observations which was not part of the Eastern block.

Table 2: Spearman's rank correlation coefficients

	$\Delta u_{i,j}$	$g_{i,j}$	$g_{i,j-1}$	$institutions_{i,j}$	$\Delta benefits_{i,j}$	$\Delta benefits_{i,j-1}$	$r.wage_{i,j}^{growth}$	$m.wage_{i,j}^{growth}$	$m.wage_{i,j}^{diff}$
$\Delta u_{i,j}$		-0.536***	-0.411***	-0.012	0.315***	0.356***	0.141**	0.193**	0.190**
$g_{i,j}$	-0.536***		0.427***	0.213***	-0.232***	-0.235***	-0.035	-0.196	-0.189
$g_{i,j-1}$	-0.411***	0.427***		0.208***	-0.089	-0.185***	-0.046	-0.226***	-0.223***
$institutions_{i,j}$	-0.012	0.213***	0.208***		0.092	0.126	0.136*	0.012	0.028
$\Delta benefits_{i,j}$	0.315***	-0.232***	-0.089	0.092		0.735***	0.069	0.106	0.106
$\Delta benefits_{i,j-1}$	0.356***	-0.235***	-0.185***	0.126	0.735***		0.031	0.098	0.102**
$r.wage_{i,j}^{growth}$	0.141**	-0.035	-0.046	0.136*	0.069	0.031		0.670***	0.675***
$m.wage_{i,j}^{growth}$	0.193**	-0.196	-0.226***	0.012	0.106	0.098**	0.670***		0.994***
$m.wage_{i,j}^{diff}$	0.190**	-0.189	-0.223***	0.028	0.106	0.102**	0.675***	0.994***	

Correlation coefficients are calculated using full sample (i.e. specification A).

Table 3 Summary statistics

Statistic	Min	Mean	Max	St. Dev.
$\Delta u_{i,j}$	-4.358	0.030	8.217	1.252
$g_{i,j}$	-10.293	2.495	13.351	3.300
$g_{i,j-1}$	-8.355	2.941	13.351	2.946
$institutions_{i,j}$	0.257	2.071	5.000	1.076
$\Delta benefits_{i,j}$	-0.300	0.003	0.460	0.117
$\Delta benefits_{i,j-1}$	-0.300	0.001	0.460	0.119
$r.wage_{i,i}^{growth}$	-9.746	1.672	43.936	4.339
$m.wage_{i,i}^{growth}$	-0.152	0.0003	0.136	0.018
$m.wage_{i,i}^{diff}$	-0.255	0.002	0.312	0.042

Statistics are calculated by using the full sample (i.e. specification A).

3 RESULTS

The estimated effect of control variables are generally in accordance with theoretical assumptions. Positive GDP per capita growth rate significantly decreases unemployment rate as well as higher rigidity of labor markets and increases in unemployment benefits. These results are robust for each sample specification with an exception of the countries of the former Eastern block. However, these results might be determined by the specific functioning of labor markets in transition economies and our data cover even the period when the transition was not yet completed.

The significance of estimated *wage* parameters differs in dependence on measure used. Coefficients estimated for the real minimum wage growth rate are positive and significant, but other measures are found insignificant. This holds for all sample specification with the exception of sample C. Estimates for sample C are in all cases negative but significant only for the growth rate of the minimum wage share on median wage. However, results for sample C might be driven by nonstandard labor market behavior. Hence hereafter we will focus on the results obtained from other samples.

The results obtained definitely do not allow us to make any simple conclusion on the relationship of minimum wage and unemployment dynamics. Both results obtained (i.e. significant positive and insignificant effect) are in accordance with theory presented in Introduction. However, apparently robust dependence of results (obtained from identical samples) on measure used raises important uneasy questions. Different significance of different measures of minimum wage might suggest that unemployment dynamics depend on some factors, which growth rate of real minimum wage reflects and other measures do not. Or the real minimum wage growth rates provide unrealistic picture of the minimum wages effect which is in fact zero and therefore truly reflected by median-based indicators. This possibility is supported by the zero mean of median-based indicators (see Table 1) which indicates

presence of simultaneous shifts of minimum and median wage. However, it would also implicate, that significant results obtained for real minimum growth rate are just coincidence, which is quite improbable with respect to obvious robustness of the results.

Our approach does not allow us to solve these questions. Nevertheless, our results have important implications for the empirical research. Especially we stress the need for careful robustness checks with respect to the measures used. Our results also call for further investigation of the impact of minimum wage on the wage distribution.

4 CONCLUSION

We provide the investigation of the relationship between changes of minimum wage and unemployment dynamics depicted by the first difference of the unemployment rate. The empirical analysis is performed by using a broad set of OECD countries in the period of 1985-2009. The minimum wage changes are described by using two kinds of measures: median wage based and the growth rate of real minimum wage. The results differ with respect to measure used. Estimated coefficients for the growth rate of the real minimum wage are positive and statistically significant. On the other hand, the results for median wage based indicators are insignificant. The difference found has no straightforward explanation. Both kinds of measures might be in fact biased with respect to true impact of minimum wage on the wage distribution. Nevertheless, our results call for careful robustness checks in empirical studies.

Acknowledgements: This paper is supported by the Masaryk University Project Grant No. MUNI/A/0844/2013

References

- [1] Bazen, S. and Skourias, N. (2000) ,Is there a negative effect of minimum wages on youth employment in France?, *European Economic Review*, vol. 41, pp. 723-732.
- [2] Blanchard, O. and Wolfers, J. (2000) ,The role of shocks and institutions in the rise of European unemployment: the aggregate evidence'. *The Economic Journal*, vol. 110, pp.1-33.
- [3] Card, D. and Krueger, A. B. (1995) ,Time-series minimum-wage studies: a meta-analysis'. *American Economic Review*, vol. 85, pp. 238-243.
- [4] Dickens, R., Machin, S. and Manning, A. (1999) ,The effects of minimum wages on employment: Theory and evidence from Britain' *Journal of Labor Economics*, vol. 17, pp. 1-22.
- [5] DiNardo, J., Fortin, N. M. and Lemieux, T. (1999) ,Labor market institutions and the distribution of wages', *1973-1992: A semiparametric approach*, No. w5093, National Bureau of Economic Research.
- [6] Feenstra, Robert C., Inklaar, R. and Timmer, M.P. (2013) ,The Next Generation of the Penn World Table, available for download at www.ggd.net/pwt
- [7] Machin, S. and Manning, A. (1993) ,Effects of Minimum Wages on Wage Dispersion and Employment: Evidence from the UK Wages Councils' *The Indus. & Lab. Rel. Rev.*, pp. 47.
- [8] Neumark, D. and Wascher, W. (1991) ,Evidence on employment effects of minimum wages and subminimum wage provisions from panel data on state minimum wage laws', No. w3859, National Bureau of Economic Research.
- [9] Neumark, D. and Wascher, W. L. (2008) ,Minimum wages'. MIT Press.
- [10] Neumark, D., Schweitzer, M. and Wascher, W. (2004) ,Minimum wage effects throughout the wage distribution'. *Journal of Human Resources*, vol. 39, pp. 425-450.

- [11] Shapiro, C. and Stiglitz, J. E. (1984) ,Equilibrium unemployment as a worker discipline device‘ *The American Economic Review*, pp. 433-444.
- [12] Stigler, G. J. (1946) ,The economics of minimum wage legislation‘ *The American Economic Review*,, pp. 358-365.

Author’s address

Jaroslav Schulz

Masaryk University, Faculty of Economics and Administration, Department of Economics.

Lipová 41a, 602 00 Brno

Czech Republic

email: 150971@mail.muni.cz

Štěpán Mikula

Masaryk University, Faculty of Economics and Administration, Department of Economics.

Lipová 41a, 602 00 Brno

Czech Republic

email: mikula@econ.muni.cz

UNIVERSITY TIMETABLING: SOME SPECIAL CONSTRAINTS

*Veronika Skocdoplova,
University of Economics, Prague*

Abstract

University timetable construction is a problem that afflicts every university before each term. In this paper a computational approach utilizing a complex mathematical model is presented. The described model uses integer goal programming, where goals represent soft constraints of the model. This model was formulated for the department of econometric at the University of Economics, Prague. In the third part of the paper two types of special conditions ensuring specific requirements of the department are delineated.

Keywords: university timetabling, goal programming, MPL, MS Excel

JEL Classification: C61

AMS Classification: 90C29

1 INTRODUCTION

Construction of a timetable is problem that is being solved at every school at the beginning of each school year. This paper focuses on construction of university timetable. There are many ways how to prepare a timetable. An ordinary scheduling board is still used very often. Also some heuristic methods can be used. On the other hand, in the age of computers and information technologies we can utilize different sophisticated methods that use mathematical modelling. There are two main approaches how to construct a timetable. One of them is creating a complex model usually with integer variables ([3], [5]). However, solving integer programming models is, in general, NP-hard problem [4], so it leads to utilizing various heuristic or metaheuristic methods ([2], [6]). Heuristic and metaheuristic methods give us solutions that are relatively close to optimal solution in relatively reasonable time. The other approach consists in decomposition of the problem into several interrelated stages ([1], [7]). This means outputs of one stage are inputs in the next stage.

In this paper a complex model for timetable construction for department of econometrics of the University of Economics, Prague is presented. The presented model utilizes integer goal programming. The current process of timetable creating for the whole university is described in detail in [9].

2 MATHEMATICAL MODEL

In this part a complex mathematical model for timetable construction at the department level is described. The model utilizes integer goal programming approach, where the aim is to minimize a weighted sum of deviations. Goal programming approach enables using both soft and hard constraints. The soft constraints are represented by goals which do not have to be fulfilled accurately.

The model is solved via MPL optimization system (maximalsoftware.com/mpl) using Gurobi solver (www.gurobi.com). The input and output data are stored in Excel sheet.

The complex model can be formulated as follows:

Minimize

$$z = p_1\delta_1^- + p_2 \sum_i (\delta_{2i}^- + \delta_{2i}^+) + p_3\delta_3^- + p_{41} \sum_l \delta_{4l}^+ + p_{42} \sum_l \delta_{4l}^- \quad (1)$$

subject to

$$\sum_j \sum_l x_{ijkl} \leq 1, \quad \forall i, k, \quad (2)$$

$$\sum_i \sum_k \sum_l x_{ijkl} = 1, \quad \forall j, \quad (3)$$

$$\sum_i \sum_j \sum_k x_{ijkl} \leq 1, \quad \forall l, \quad (4)$$

$$\sum_j \sum_k \sum_l x_{ijkl} + \delta_{2i}^- - \delta_{2i}^+ = PK_i, \quad \forall i, \quad (5)$$

$$\sum_i \sum_j \sum_k \sum_l PS_{ij} x_{ijkl} + \delta_1^- - \delta_1^+ = PREF_S, \quad (6)$$

$$\sum_i \sum_j \sum_k \sum_l PT_{ik} x_{ijkl} + \delta_3^- - \delta_3^+ = PREF_T, \quad (7)$$

$$\sum_k \sum_l x_{ijkl} \leq PS_{ij}, \quad \forall i, j, \quad (8)$$

$$\sum_j \sum_l x_{ijkl} \leq PT_{ik}, \quad \forall i, k, \quad (9)$$

$$\sum_i \sum_j \sum_k CAP_j x_{ijkl} + \delta_{4l}^- - \delta_{4l}^+ = \sum_i \sum_j \sum_k KAP_l x_{ijkl}, \quad \forall l, \quad (10)$$

$$\sum_i \sum_k \sum_l OKNO_k x_{ijkl} = \sum_i \sum_k \sum_l TW_l x_{ijkl}, \quad \forall j, \quad (11)$$

$$\sum_i \sum_j \sum_l PC_l x_{ijkl} \geq \sum_i \sum_j \sum_l COMP_j x_{ijkl}, \quad \forall k, \quad (12)$$

$$x_{ijkl} \in \{0, 1\}, \quad \forall i, j, k, l, \quad (13)$$

$$\delta_1^-, \delta_1^+, \delta_{2i}^-, \delta_{2i}^+, \delta_3^-, \delta_3^+, \delta_{4l}^-, \delta_{4l}^+ \geq 0, \quad \forall i, l,$$

where the binary decision variable x_{ijkl} equals 1, if the teacher i is assigned to the course j in the time window k in the classroom l , and 0 otherwise. PK_i is number of course loads for teacher i ; PS_{ij} represents teacher's preferences of the courses as well as PT_{ik} is teacher's preferences of the teaching time. $PREF_S$ and $PREF_T$ are goals representing the total preferences of courses or time. CAP_j is required capacity of a classroom for course j , KAP_l is a capacity of the classroom l . $OKNO_k$ is a serial number of time window k , TW_l is the number of time window in which is the classroom l available. PC_l represents whether the room l is equipped with student's computers ($PC_l = 1$) or not ($PC_l = 0$); $COMP_j$ indicates, whether student's computers are necessary for teaching the course j ($COMP_j = 1$) or not ($COMP_j = 0$). There are also weights (or priorities) of each goal ($p_1, p_2, p_3, p_{41}, p_{42}$) and deviations from each goal ($\delta_1^-, \delta_1^+, \delta_{2i}^-, \delta_{2i}^+, \delta_3^-, \delta_3^+, \delta_{4l}^-, \delta_{4l}^+$).

In the model there are four goals represented by soft constraints. First goal constraint (5) represents given course load of each teacher, where both positive and negative deviations ($\delta_{2i}^-, \delta_{2i}^+$) are minimised. In the second and third goal (6), (7) the total course or time preferences are maximised, therefore only the negative deviations (δ_1^-, δ_3^-) are minimised. The last goal (10) deals with classroom capacities: capacity of the course should not exceed the capacity of

assigned classroom on the one hand; the classroom should not be too big for small courses on the other hand (e.g. course for 20 students should not be assigned to a classroom for 100 students, if it is possible). Hence both positive and negative deviations are minimised but with different priorities. The objective function (1) minimizes weighted sum of above mentioned deviations.

The hard constraints ensure the basic rules of the timetable. In each time window k every teacher i can teach maximum one course (2). Each course j has to be assigned to a teacher, time window and classroom (3). In each classroom l there can be assigned maximum one course (4). If the preference of course j by teacher i equals 0, the teacher may not teach that course (8). If the preference of time window k by teacher i equals 0, the teacher may not teach in that time window (9). If the course j is assigned to the classroom l and time window k , the classroom has to be available at that time (11). If student's computers are necessary for the course j and the course is assigned to the classroom l , the classroom has to be equipped with computers (12).

3 SPECIAL CONSTRAINTS

The model described in the previous section is just a basic model that ensures fulfilling the main rules of a timetable. Nevertheless in timetable construction there can emerge some special constraints that follow e.g. other teachers' preferences. In this part two types of special constraints are described.

The first of them is another expression of teachers' preferences. The following constraints can be simply added to the previous model:

$$y_m \leq \sum_j \sum_{k \in d_m} \sum_l x_{ijkl}, \quad \forall i, m, \quad (14)$$

$$y_m |d_m| \geq \sum_j \sum_{k \in d_m} \sum_l x_{ijkl}, \quad \forall i, m, \quad (15)$$

$$\sum_m y_m + \delta_{5i}^- - \delta_{5i}^+ \leq PD_i, \quad \forall i, \quad (16)$$

$$y_m \in \{0, 1\}, \quad \forall m, \quad (17)$$

$$\delta_{5i}^-, \delta_{5i}^+ \geq 0, \quad \forall i,$$

where binary variable y_m equals 1 if the teacher i has any course in the day m , and 0 otherwise. Using this group of constraints it can be set up in the model how many days per week should the teacher work. The number of days per week for each teacher (PD_i) would be the fifth goal of the model. Only the positive deviation (δ_{5i}^+) would be minimised in the objective function.

The other constraints follow the special request of department of econometrics for classrooms equipped with students' computers. Due to lack of computer classrooms not all courses where computers are used are assigned to computer classrooms. Some courses rotate between usual and computer classroom (one week with PC, one without). This can be ensured by following set of constraints that replaces constraint (12).

$$\sum_i \sum_{j \in PCp} \sum_l PC_l x_{ijkl} \geq \sum_i \sum_{j \in PCp} \sum_l COMP_j x_{ijkl}, \quad \forall k, \quad (18)$$

$$\sum_i \sum_{j \in PCf} \sum_l PC_l x_{ijkl} = \sum_i \sum_{j \in PCf} \sum_l COMP_j x_{ijkl}, \quad \forall k, \quad (19)$$

$$\sum_i \sum_{j \in PCn} \sum_l PC_l x_{ijkl} = \sum_i \sum_{j \in PCn} \sum_l COMP_j x_{ijkl}, \quad \forall k, \quad (20)$$

where parameter $COMP_j$ equals 1, if the course j has to be assigned to a computer classroom for all its lectures (19), 0.5 when the course j rotates between usual and computer classroom (18), and 0 when computers are not required for the course j (20). The other notation is the same as in the previous model.

4 CONCLUSION

The presented model has been tested only on a small data set. The real data has to be collected and adjusted for the model purpose. If there are problems with solving the complex model with real data (although Gurobi solver has good results in solving integer models in reasonable time), the model can be modified to the decomposed model with interrelated stages as it is suggested in [8]. During the future research other constraints might be added, such as constraints following other teachers' requirements (e.g. to teach maximum 2 courses in one block).

Acknowledgements: This work was supported by the Internal Grant Agency of the University of Economics, Prague (grant no. F4/11/2013).

References

- [1] Al-Husain, R., Hasan, M. K. and Al-Qaheri, H. (2011) 'A Sequential Three-Stage Integer Goal Programming (IGP) Model for Faculty-Course-Time-Classroom Assignments', *Informatica*, vol. 35, pp. 157–164.
- [2] Aladag, C., Hocaoglu, G. and Basaran, M. (2009) 'The effect of neighbourhood structures on tabu search algorithm in solving course timetabling problem', *Expert Systems with Applications*, vol. 36, pp. 12349–12356.
- [3] Bakir, M. A. and Aksop, C. (2008) 'A 0-1 Integer Programming Approach to a University Timetabling Problem', *Hacettepe Journal of Mathematics and Statistics*, vol. 37, pp. 41–55.
- [4] Cerny, M. (2012) *Computations, Volume III (In Czech)*, Prague: Professional Publishing.
- [5] Daskalaki, S., Birbas, T. and Housos, E. (2004) 'An integer programming formulation for a case study in university timetabling', *European Journal of Operational Research*, vol. 153, pp. 117–135.
- [6] De Causmaecker, P., Demeester, P. and Berghe, G. (2009) 'A decomposed metaheuristic approach for a real-world university timetabling problem', *European Journal of Operational Research*, vol. 195, pp. 307–318.
- [7] Mirrazavi, S. K., Mardle, S. J. and Tamiz, M. (2003) 'A Two-Phase Multiple Objective Approach to University Timetabling Utilising Optimisation and Evolutionary Solution Methodologies', *The Journal of the Operational Research Society*, vol. 54, pp. 1155–1166.
- [8] Skocdoplova, V. (2013) 'University timetable construction – computational approach' *Mathematical Methods in Economics 2013 – Conference Proceedings*, The Czech Society for Operations Research Conference, Jihlava, pp. 808–813.
- [9] Skocdoplova, V. (2013) 'Construction of a university timetable via goal programming' *Efficiency and Responsibility in Education*, Praha, pp. 565–572.

Author's address

Ing. Veronika Skočdoplová
 University of Economics, Prague,
 Faculty of Informatics and Statistics, Department of Econometrics
 Nám. W. Churchilla 4, 130 67 Praha
 Czech Republic
 email: veronika.skocdoplova@vse.cz

POLICYHOLDER'S RISK IN CZECH AND SLOVAK BONUS-MALUS SYSTEMS

*Radek Stolín,
College of Polytechnics Jihlava*

Abstract

Both countries of the former federation started a systematic application of bonus-malus systems in automobile insurance at the beginning of the 21st century. The premium has become a random variable and policyholders have taken a part of risk from the insurer to themselves since. The main goal of the paper is to answer the following question. What is the present ability of the Czech and Slovak bonus-malus systems to pass the risk on to policyholders? That ability is expressed quantitatively using Schnieper's formula for risk's division. The paper also offers a relative expression of the risk to the risk in a hypothetical bonus-malus system in which each policyholder would pay premium worth the average total costs associated with their insurance policy.

Keywords: *bonus-malus system, effectiveness, risk distribution, transition matrix*

JEL Classification: C46

AMS Classification: 91B30

1 INTRODUCTION

In general, the bonus-malus system (BMS) is a system that adjusts the premium paid by a policyholder according to his or her individual claim history. Each BMS consists of several classes in which different premiums are charged. There is a starting class with the basic premium, furthermore other classes with discounts (the so called bonus classes) and some classes with premium surcharges (the so called malus classes). Drivers are divided into the classes on the history of the number of their individual claims during the given time period (usually the so called policy year).

BMSs were introduced in Europe as soon as in the early 1960s. There are many quantitative criteria which had been defined by various authors to compare and evaluate different BMSs. A lot of those criteria could be found in J. Lemaire (1985, 1995) who summarized existing literature and provided the complete description and quantitative comparison of 31 BMSs applied in automobile insurance around the world at the end of 20th century. Neither Czech nor Slovak BMSs are mentioned in the introduced works because the both countries started application of their BMSs in automobile insurance systematically as late as at the beginning of the 21st century. The premiums of Czech and Slovak policyholders have been since then of the stochastic nature and the policyholders carry a part of the risk of the total costs associated with their insurance policy. The very size of the part is what the paper is dealing with.

Prevailing distribution models of some random variables which are needed for the calculation are briefly introduced in this paper, namely the number of claims, the cost of claims, the total insurer's costs, and the duration of insurance policy (Lemaire 1985, 1995, Mandl, Mazurová 1999). Next a covariance model of the risk distribution (Schnieper 1997, 1999) is brought out and a formula for the calculation of the size of policyholder's risk is given (Stolín 2013). Then a hypothetical BMS with the maximal individualization of premium and the size of policyholder's risk in it is considered. Further the effectiveness of a BMS is defined using proportion of the two risks and finally the BMSs that operate on the Czech and Slovak motor third-party liability insurance market are ranked by their effectiveness.

The accomplished calculations show that presently used BMSs in both Czech and Slovak Republic pass very small part of risk on to their policyholders, only less than 1 per cent of the total risk. However, there are considerable differences among them. The effectiveness of the BMSs ranges from 3 up to 22 per cent.

The main goal of the paper has been to calculate the risk of the policyholders of Czech and Slovak BMSs applied in motor third-party liability insurance in 2014, compare it with the total risk, and rank those systems by the proportion of the risk to the risk in a hypothetical BMS in which the individualization of premium is maximal.

2 MATERIALS AND METHODS

2.1 Czech and Slovak BMS as a Markov chain

By definition, an insurance company uses a BMS when dividing the policyholders of a given tariff group into several, say s , classes. The annual premium charged depends only on the class. There is a specified starting class in which each policyholder begins his or her driving carrier. The positioning of a policyholder for a given policy year is determined unambiguously only by the class for the preceding policy year and the number of claims reported during the period. Such a system, along with the assumption that the policy-year numbers of claims are mutually independent, forms a Markov chain. A Markov chain is a stochastic process in which the future development depends only on the present state but not on the history of the process or the manner in which the present state was reached. In a BMS the different classes represent the states of the chain. The knowledge of the present class and the number of claims reported during the policy year suffices to determine the next year's class. A BMS is determined by three following elements:

- the column vector of premiums $\mathbf{c} = (c_1, c_2, \dots, c_s)'$ charged in the corresponding classes;
- the starting class c_{i_0} ;
- the transition rules that determine the transfer from one class to another by number of claims in preceding policy year.

In Czech and Slovak BMSs a new policyholder is placed into a starting class with the so called basic premium (neither bonus nor malus). All the policyholder's next placements depend on the so called determining period at the end of each policy year. The determining period is the duration of the policy diminished on any claim mostly by given number of months. If the determining period is defined as limited, there is a maximum and a minimum, then the BMS has all the attributes to form a Markov chain. It holds, for instance, for ČSOB poist'ovňa, Allianz poist'ovňa, Astra poist'ovňa, and so on. However, the determining period is often not limited, which means that that BMS does not form a Markov chain. But our results will not be significantly different if it is assumed that some limits exist. Sometimes it is necessary to add a class or more classes into BMS to reach the properties of a Markov chain. If a BMS forms a Markov chain, for a policyholder with the claim frequency \mathcal{G} there is a transition matrix $\mathbf{P}(\mathcal{G}) = \|p_{ij}(\mathcal{G})\|_{i,j=1}^s$ consisting of transition probabilities of going from class i to class j at a policy anniversary.

2.2 Distribution models of the number and cost of claims

Let us assume (Mandl, Mazurová 1999) the number of claims N of a policyholder during his or her policy year has a Poisson distribution where the Poisson parameter is itself a random variable, distributed according to a Gamma distribution.

$$P(N = n) = \int_0^{\infty} \frac{\mathcal{G}^n}{n!} e^{-\mathcal{G}} \frac{\tau^h}{\Gamma(h)} \mathcal{G}^{h-1} e^{-\tau\mathcal{G}} d\mathcal{G}, \quad E(N) = \frac{h}{\tau}, \quad \text{Var}(N) = \frac{h(1+\tau)}{\tau^2}. \quad (1)$$

The total cost of claims S_0 of a policyholder during a policy year is

$$S_0 = \sum_{k=1}^N X_k, \quad (2)$$

where X_1, X_2, \dots, X_N denote the costs of claims for reported accidents by the policyholder caused during the policy year. Let us assume (Mandl, Mazurová 1999) the cost of any claim X has the exponential distribution described by the probability density function

$$u(x) = \alpha e^{-\alpha x}, \quad E(X) = \frac{1}{\alpha}, \quad \text{Var}(X) = \frac{1}{\alpha^2}. \quad (3)$$

It is possible to prove (Mandl, Mazurová 1999) that

$$E(S_0) = \frac{h}{\tau\alpha}, \quad \text{Var}(S_0) = \frac{h(1+2\tau)}{(\tau\alpha)^2}. \quad (4)$$

2.3 A distribution model of insurer's costs

The total cost of insurance company S per a policyholder for his or her insurance year consists of the coverage of the claims and all kind of other expenses associated with the policy. If the expense and risk ratio in the premium is denoted as η and it is assumed that the expense ratio in the premium makes $\frac{1}{2}\eta$, the insurer's costs could be modelled (Stolín 2013) as

$$S = S_0 + \frac{1}{2}\eta \frac{1}{\alpha(1-\eta)} \Theta = S_0 + a\Theta, \quad E(S) = \frac{h}{\tau} \left(\frac{1}{\alpha} + a \right), \quad \text{Var}(S) = \frac{2h}{\tau a^2} + \left(\frac{1}{\alpha} + a \right)^2 \frac{h}{\tau^2}. \quad (5)$$

The risk R is usually expressed as the square root of the variance, thus as the standard deviation. If the premium charged was a fixed amount, the insurer would take the entire risk.

2.4 Premium as a random variable

It is obvious that premium paid by a policyholder within an applied BMS is a random variable, say \bar{S} , and it obviously holds

$$\bar{S} = \pi_b c_l, \quad E(\bar{S}) = \frac{h}{\tau\alpha(1-\eta)}, \quad (6)$$

where c_l is the random variable whose realizations are the components of $\mathbf{c} = (c_1, c_2, \dots, c_s)'$ - the vector of premiums in single classes expressed relatively to the basic class premium π_b . Considering that the random variable duration of a policy in the BMS has the geometric distribution with the parameter q (Mandl, Mazurová, 1999), it is possible to derive (Stolín 2013) that

$$\pi_b = \frac{h}{\tau\alpha(1-\eta)(1-q) \int_0^{\infty} \frac{\tau^h}{\Gamma(h)} g^{h-1} e^{-\tau g} \mathbf{p}' (\mathbf{I} - q\mathbf{P}(g))^{-1} \mathbf{c} dg}. \quad (7)$$

2.5 A risk distribution model

The random variable S introduced in section 2.3 can be written as

$$S = \bar{S} + \bar{\bar{S}}, \quad (8)$$

where \bar{S} represents the part of costs paid by the policyholder and $\bar{\bar{S}}$ is the remainder paid by the insurer. The total risk R is possible to divide into two parts (Schnieper 1997, 1999) as

$$R = \frac{\text{Cov}(S, \bar{S})}{\sqrt{\text{Var}(S)}} + \frac{\text{Cov}(S, \bar{\bar{S}})}{\sqrt{\text{Var}(S)}} = \bar{R} + \bar{\bar{R}}. \quad (9)$$

The policyholder carries through BMS the part \bar{R} and the other part $\bar{\bar{R}}$ remains to the insurer. We will be interested in the so called rate of policyholder's risk

$$p = \frac{\bar{R}}{R} = \frac{\text{Cov}(S, \bar{S})}{\text{Var}(S)}. \quad (10)$$

It could be derived (Stolín, 2013) that

$$\text{Cov}(S, \bar{S}) = \pi_b \left(\frac{1}{\alpha} + a \right) (1-q) \int_0^\infty \frac{\tau^h}{\Gamma(h)} \mathcal{G}^h e^{-\tau \mathcal{G}} \mathbf{p}^1 (\mathbf{I} - q\mathbf{P}(\mathcal{G}))^{-1} \mathbf{c} d\mathcal{G} - \frac{h^2}{\tau^2 \alpha (1-\eta)} \left(\frac{1}{\alpha} + a \right), \quad (11)$$

where $\mathbf{p}^1 = (p_1^1, p_2^1, \dots, p_s^1)$ is the vector of the probabilities that the policyholder will be in the class i on the start of his or her insurance career.

2.6 Maximal individualization of premium

Let us consider a BMS in which each policyholder pays premium based on size of his or her own claim frequency \mathcal{G} . Mathematically

$$\pi(\mathcal{G}) = \frac{\mathcal{G}}{\alpha(1-\eta)}. \quad (12)$$

Let \bar{S}_{\max} denotes the corresponding random variable and \bar{R}_{\max} the corresponding risk. Obviously it holds

$$\bar{S}_{\max} = \frac{\Theta}{\alpha(1-\eta)}, \quad \bar{R}_{\max} = \frac{\text{Cov}(S, \bar{S}_{\max})}{\sqrt{\text{Var}(S)}}. \quad (13)$$

For the corresponding covariance we get gradually

$$\begin{aligned} \text{Cov}(S, \bar{S}_{\max}) &= E(S \bar{S}_{\max}) - E(S)E(\bar{S}_{\max}) = \\ &= \frac{1}{\alpha(1-\eta)} \left(\frac{1}{\alpha} + a \right) \int_0^\infty \mathcal{G}^2 \frac{\tau^h}{\Gamma(h)} \mathcal{G}^{h-1} e^{-\tau \mathcal{G}} d\mathcal{G} - E(\Theta) \left(\frac{1}{\alpha} + a \right) \frac{E(\Theta)}{\alpha(1-\eta)} = \\ &= \frac{1}{\alpha(1-\eta)} \left(\frac{1}{\alpha} + a \right) [E(\Theta^2) - E(\Theta)^2] = \\ &= \frac{1}{\alpha(1-\eta)} \left(\frac{1}{\alpha} + a \right) \text{Var}(\Theta) = \frac{h}{\tau^2 \alpha (1-\eta)} \left(\frac{1}{\alpha} + a \right). \end{aligned} \quad (14)$$

2.7 Effectiveness of BMS

The preceding considerations offer a way how to evaluate a BMS by the rate of individualization of premium. Let us define the effectiveness e of a BMS as

$$e = \frac{\bar{R}}{\bar{R}_{\max}}. \quad (15)$$

3 RESULTS

Calculations of the rates of policyholder's risk p and the effectiveness e of the BMSs according to the former introduced mathematical models and considering that $h=1.5625$, $\tau=15.625$ (Mandl, Mazurová 1999), $\eta=0.2$, $q=0.9$ (the average duration of a policy is ten years) and $\alpha=1$ (the average cost of one claim is a currency unit) were carried out for eleven insurance companies that offer the motor third-party liability insurance in the Slovak Republic and for twelve in the Czech Republic. In the Czech Republic all systems use both bonus and malus classes consistently. On the contrary, in the Slovak Republic there are some systems that use only bonus classes (Kooperativa, Groupama Garancia and Komunálna poisťovňa) and one insurance company (Wüstenrot) does not even apply any BMS. The rules for positioning into classes of the BMS of Gerentel poisťovňa are defined ambiguously. Their formulation enables various possibilities about grading of the policyholders. The recommended rules introduced in the corresponding general conditions of insurance [5] are applied for the calculation.

The calculations show that the values of the rates of policyholder's risk p are in all BMSs in question less than one per cent. However, the differences among insurance companies are significant, which the appropriate effectiveness e illustrates better. The following table

summarizes the calculated rates p and the effectiveness e of the BMSs that operate on the Czech and Slovak motor third-party liability insurance market nowadays.

Table 1 Ranking of Czech and Slovak BMSs by the rate policyholder's risk and effectiveness

insurance company	country	p (%)	e (%)
Wüstenrot	CZ	0.9715	22.4634
Astra	SK	0.9295	21.4912
Slavia	CZ	0.7921	18.3156
ČSOB	CZ	0.6862	15.8656
Allianz	CZ	0.6779	15.6756
Generali	SK	0.6643	15.3611
Česká podnikatelská pojišťovna	CZ	0.6274	14.5078
Allianz	SK	0.5936	13.7245
Česká pojišťovna	CZ	0.5703	13.1878
Uniqa	CZ	0.5698	13.1745
Genertel	SK	0.5545	12.8211
Uniqa	SK	0.5188	11.9967
Komunálna poisťovňa	SK	0.4988	11.5334
Kooperativa	SK	0.4988	11.5334
Generali	CZ	0.4395	10.1611
Triglav	CZ	0.4389	10.1489
AXA	CZ	0.4289	9.9167
AXA	SK	0.4289	9.9167
ČSOB	SK	0.3992	9.2311
Hasičská vzájemná pojišťovna	CZ	0.3866	8.9400
Kooperativa	CZ	0.3156	7.2967
Union	SK	0.2433	5.6256
Groupama Garancia	SK	0.1309	3.0278

Source: [1], [5] and own calculations

4 CONCLUSIONS

The calculations show that in spite of using BMS the insurer keeps on carrying nearly all the risk. Numerically expressed, the insurer still takes more than 99 per cent of the total risk. This result is quite understandable because the amount of premium depends directly only on the number of accidents caused by the policyholder and the associated costs of claims have no influences on this amount.

It is shown, however, that the rate of policyholder's risk is very various for different BMSs. These differences are more obvious on comparison of the policyholder's risk to the risk which takes a policyholder in the BMS presented in section 2.6. That BMS enables the maximal individualization of premium according to the accident frequency of each policyholder. As far as effectiveness is concerned the Wüstenrot pojišťovna takes the first place among the all considered Czech and Slovak insurance companies. Its effectiveness makes more than 22 per cent. The relatively strict rules on which its BMS operates (one claim decreases the determining period by 36 months along with rather high average differences between the premiums charged in adjacent classes) are the main reasons. On the contrary the Groupama Garancia poisťovňa (one claim decreases the determining period only by 12 months) has the lowest effectiveness, about 3 per cent. A lot of the Czech insurance companies have changed their BMS since 2014 to increase their effectiveness. The Slavia pojišťovna, for instance, takes away from the determining period 36 months instead of 12 months for each claim (the others conditions unchanged) from 1 January 2014. This change has caused that the rate of policyholder's risk is about five times higher (Stolín 2013). Some Czech insurance companies newly do not count the

month when a claim occurs into the determining period, which implies a considerable increase of effectiveness too.

The found out results indicate: the bigger change in premium for causing a claim the higher effectiveness of the corresponding BMS. This conclusion also confirms a BMS presented by Lemaire (1995). The BMS (applied in Switzerland) consisted of 22 classes with a maximal discount of 55 per cent of the basic premium and a maximal surcharge of 170 per cent of the basic premium. One claim means a fall by 4 classes. It is possible according to the presented way to work out the effectiveness of that system makes nearly 30 per cent. If the insurers wanted to pass more risk on to their policyholders, they should construct harder BMSs for them.

References

- [1] ABC pojištění: Pojišťovny, [Online], Available: <http://www.abcpojisteni.cz/pojistovny> [2014-03-02].
- [2] Lemaire, J (1985) *Automobile Insurance*, Boston/Dordrecht/ Lancaster: Kluwer – Nijhoff Publishing.
- [3] Lemaire, J (1995) *Bonus-Malus System in Automobile insurance*, Boston/Dordrecht/ London: Kluwer Academic Publishers.
- [4] Mandl, P. and Mazurová, L. (1999) *Matematické základy neživotního pojištění*, Praha: Matfyzpress.
- [5] Poistovne.sk: Zoznam poisťovní, [Online], Available: <http://www.poistovne.sk/10/zoznam-poistovni-poistovnesk.php> [2014-03-02].
- [6] Schnieper, R. (1997) ‘Capital Allocation and Solvency testing’, *SCOR Notes*, January, pp. 49 - 104.
- [7] Schnieper, R. (1999) ‘Solvency Testing’, *Mitteilungen Schweiz, Aktuarvereinigung*, pp. 11 - 45.
- [8] Stolín, R. (2013) ‘A Model of Risk Distribution in Czech Bonus-Malus Systems’, *Mathematical Methods in Economics 2013 – Conference Proceedings*, The Czech Society for Operations Research Conference, Jihlava, pp. 868 – 874.

Author's address

RNDr. Radek Stolín, Ph.D.
College of Polytechnics Jihlava, Department of Mathematics
Tolstého 16, 586 01 Jihlava
Czech Republic
e-mail: radek.stolin@vspj.cz

OKUN'S LAW VERIFICATION AT THE SLOVAK REGIONS DATA

*Kvetoslava Surmanová, Marian Reiff,
University of Economics in Bratislava*

Abstract

Unemployment is a phenomenon that negatively affects life in each country. In Slovakia this phenomenon has been unknown for a long time. The development in the early 90s influenced the existing economic environment and unemployment has become a phenomenon that needs to be addressed. Sustainable economic growth and low unemployment rate are the most commonly defined objectives of economic policy. Unemployment is a problem that affects not only the lives of unemployed citizens, but also its surroundings. The concept of unemployment or employment is well known in a number of economic theories, for example: Okun's law, Phillips curve, Say's theory of production factors, etc.

The aim of the paper is to examine regional disparities in terms of the validity of the Okun's law in the Slovak regions, using annual data from a regional database of the Slovak Statistical Office for the period of 2002 - 2011. The attention is focused on the possibility of considering the effect of the Okun's law in times of crisis, when the drop of the economy has occurred. For the analysis, the methodology of panel data was chosen

Keywords: *Unemployment, Panel Data, Okun's Law*

JEL Classification: C23,

AMS Classification: 91G70

1 WHAT IS OKUN'S LAW?

Okun's law was first qualified by Arthur M. Okun in 1962. It is an empirically observed relationship relating unemployment to losses in a country's production. Okun published two versions of relation of unemployment and GDP.

First relation "gap version" states that for every one % increase in the unemployment rate, a country's GDP will be roughly two % lower than its potential GDP. Analytically it can be stated as follows:

$$\Delta U = a + b(y^* - y), \text{ where} \quad (1)$$

ΔU denotes the change in the unemployment rate,

y^* is potential output,

y is actual output.

Parameter b is known as Okun's coefficient. Ratio $(-a/b)$ denotes the output growth rate consistent with a stable unemployment rate, or how fast the economy must grow in order to maintain a given level of unemployment.

Another version is called "difference version". It describes the relationship between changes in unemployment and changes in real GDP and it is stated as follows:

$$\Delta U = a + b(gGDP), \text{ where} \quad (2)$$

$gGDP$ is the change in real output growth rate.

The Okun has noted that the both relationships are problematic. "Gap version" is linked to the problem of obtaining the negative potential output and also is defined as a very simple analytical relation. This has led economists to construct other versions: "dynamic version" and "production-function version".

Description of the dynamic version can be found, for example in Knotek (2007). Difference version is extended version of past real output growth and past change in the unemployment rate as a variable on the right side of the equation. Dynamics may not only be a delay of one observation. Version is based on the production function approach and combines theoretical production function with difference version.

1.1 Okun's coefficient consistency - literature overview

Several authors have addressed verification of the validity of the Okun's law in the Slovak economy. For example Košta et al. (2011) analyzes the labor market in Slovakia in an extensive monograph of international comparison within the countries of the European Union or its representatives selected. Their results show strong relationship intensity between economic growth and unemployment. In the empirical analysis they have proved the validity of the Okun's law but also indicated that GDP growth does not necessarily mean a decrease of unemployment for number of reasons. For example, the GDP growth is not the only factor affecting unemployment, but it may be the result of new technologies introduction into the production, etc. Buttinger (2013) asks whether Okun's law can be applied to the Slovak Republic and how the Slovaks compare to order economically stable nations in Europe and North America. Empirical analyses are divided into three time periods: 1945 – 1990, 1990 – 1993 and 1993 – 2013. The third time period shows better results than expected. According to author, the data presents a literal textbook example of how Okun's law is displayed over the time and the observations in this paper of Slovakia's growth and progress show that its Okun's law coefficient and its consistently positive output growth rate indicate many prosperous years in the future. The results allow one to calculate the natural rate of unemployment for the time period and use it to compare results to other research of Slovakia and additional countries.

Did Okun's law hold into Slovak labour market during of the crisis? This question was analyzed by D'Apice (2014). Study using the methodology of panel data analyzes relation between change in the unemployment rate and output growth in Visegrad countries and Germany. In the Slovak case, a relatively higher rate of GDP growth (from analyzed countries) is needed for the unemployment rate to fall.

Other works that dealt with the empirical assessment of validity of the Okun's law in Slovakia are for example: Hutengs and Stadtmann (2013), Economou and Psarianos (2013), etc.

The following table shows the results of the analysis of the Okun's law in Slovakia from selected studies.

Author	Time period	Okun's coefficient	rate of GDP	R-squared	Frequency data
Košta a kol. (2011)	1995 - 2008	-0.613	4,89	0,82	-
Dujava D. (2009)	1995 - 2008	-0,71	4,56	0,85	annual data
D'Apice P. (2014)	1994- 2013	-0,3	4,73	0,36	quarterly data
Buttinger (2013)	1993 - 2011	-0,3685	4,26	-	annual data

Table 1: Overview of selected empirical studies

Values in column named rate of GDP express the real growth of GDP needed to ensure a constant level of unemployment. Based on the results, we can conclude that although the authors analyzed the different time intervals and the Okun's coefficient has a different values, the value of the GDP growth rate needed to maintain the unemployment rate is more or less consistent over time (4,26 to 4,89).

1.2 Dependence of the growth rate of GDP and changes in the unemployment rate

In this part, firstly we will graphically highlight the dependence of monitored indicators of

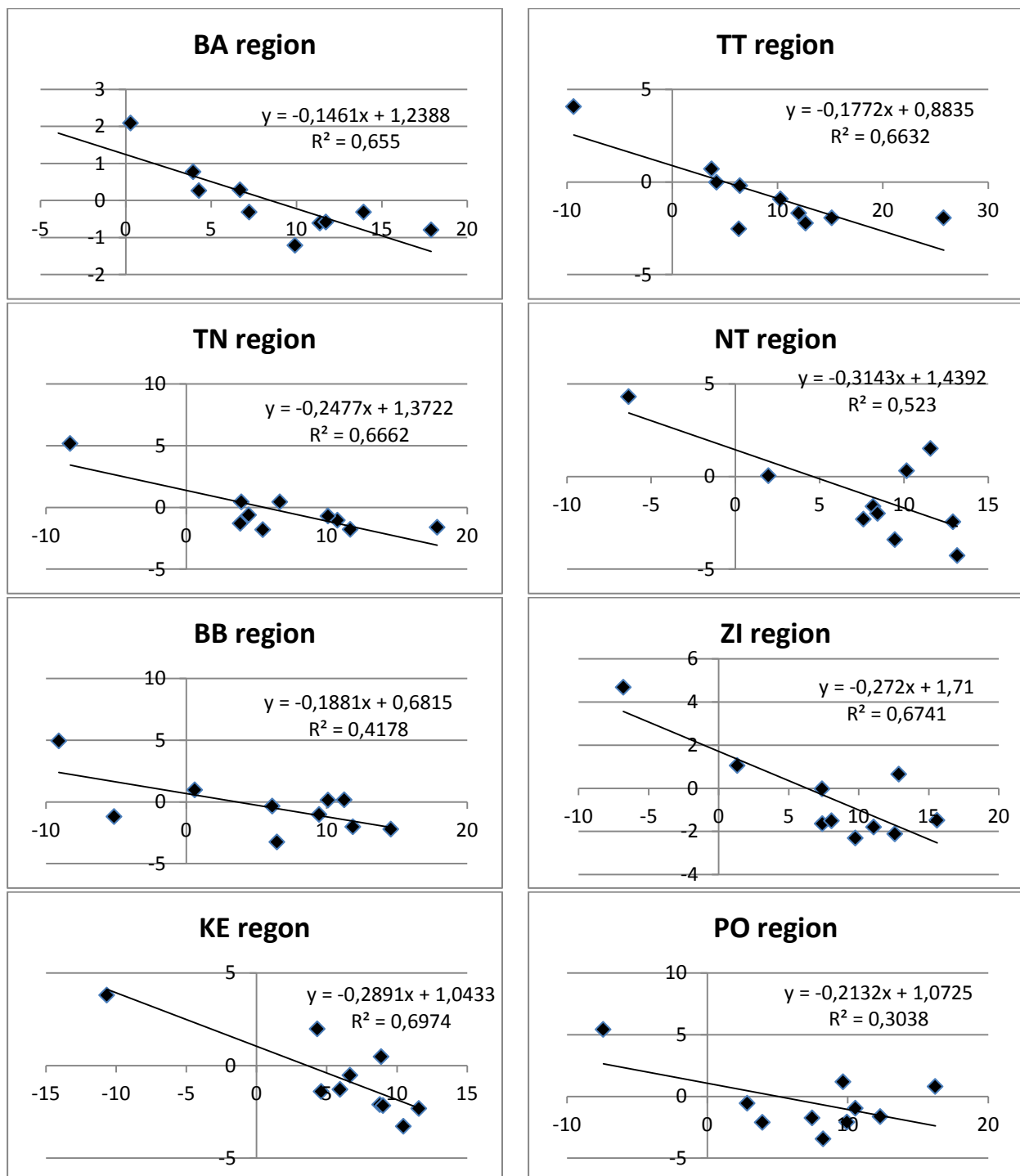

Figure 1 XY dependence of changes in the unemployment rate and the growth rate of GDP

Source: own calculations from Statistical Office data Note: BA – Bratislava region, TT – Trnava region, TN – Trenčín region, NT – Nitra region, ZI – Žilina region, BB – Banská Bystrica region, PO – Prešov region and KE – Košice region.

GDP growth rates and changes in unemployment rates across regions of Slovakia. X-axis on all figures expresses the growth rate of GDP and the y-axis represents the change in the unemployment rate. In all regions, negative correlation is clearly visible between the change in the unemployment rate and the growth rate of real GDP. Outlying observations (values shown in quadrant 4) capture period of 2009, when consequences of the crisis are demonstrated in Slovakia. As we can see in Figure 2, the economy has slowed down, the growth rate of GDP reached even negative value and gains in unemployment rates were the highest for the period.

Afterwards there is a gradual fall of the economy until revive of the economy and reverse improvement of economic key indicators.¹

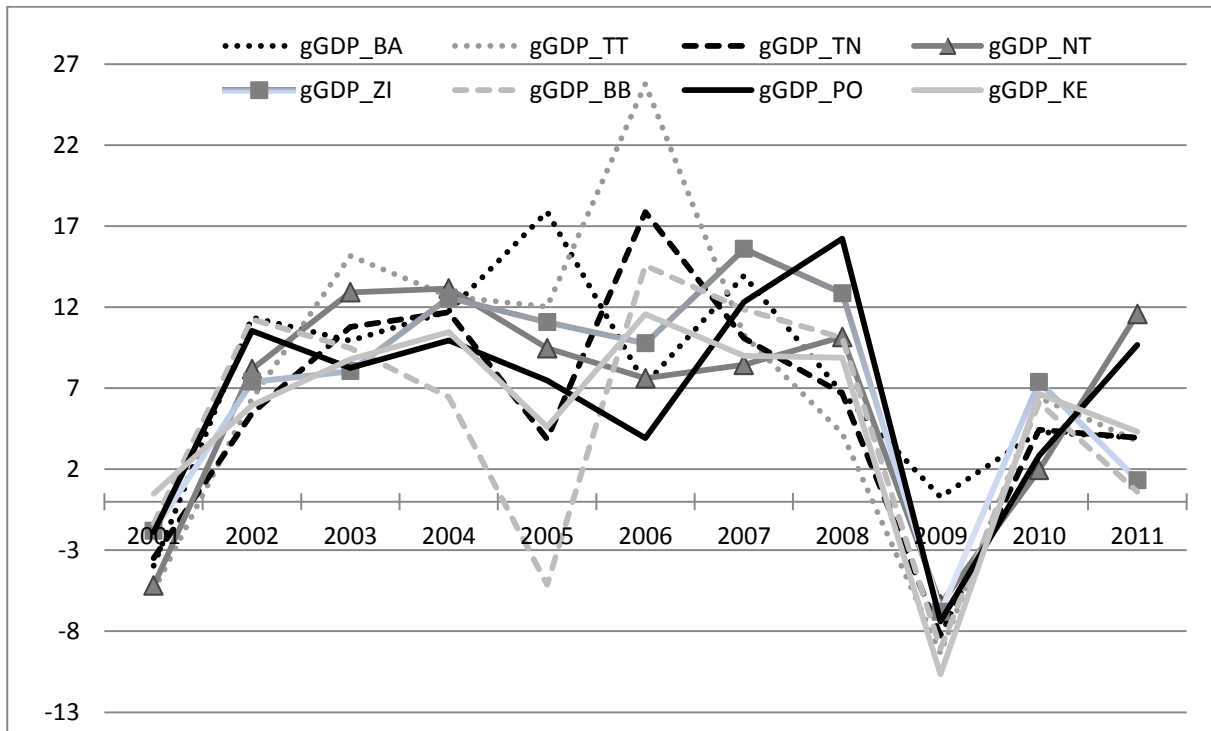

Figure 2 Real output growth in regions of Slovak republic

Table 2 shows strength of dependence between the change in the unemployment rate and growth rate of real GDP that can capture statistical method, i.e. correlation coefficients.

Region	Correlation coefficient
BA	-0,809310755
TT	-0,814351964
TN	-0,816200188
NT	-0,723219951
ZI	-0,821036269
BB	-0,646350039
PO	-0,551141938
KE	-0,835123098

Table 2 Correlation coefficient in regions

A higher degree of mutual dependence is negative in Bratislava, Trnava, Trenčín, Žilina and Košice region, where the value of the correlation coefficient is less than -0.8. Medium strength dependence is considered when the correlation coefficient takes the values from 0.4 to 0.8. Within that range all the remaining region are covered: Nitra, Banska Bystrica and Prešov. Presented results suggest presence of strong negative relationship between the two indicators examined. Therefore, in the next chapter, the methodology of panel data is used, focusing mainly on disparities between regions.

¹ Interested readers can find more information about business cycle in Lukáčik et al. (2010).

2 OKUN'S LAW ON REGIONS OF SLOVAKIA

We performed an analysis based on the classification of NUTS3 for 8 regions of the Slovak economy on the annual regional Slovak Statistical office data for the period 2002 - 2011. Due to insufficient number of observations, panel data methodology was used. It offers several advantages, additional degrees of freedom present in pooled data can produce accurate estimates and higher variability of regressors can mitigate collinearity problems typical for macroeconomic data. To verify the validity at the regional level the differential version represented by equation 2 was chosen, written in stochastic form as follows:

$$\Delta U_{it} = \beta_0 + \beta_1(gGDP_{it}) + u_{it}, \quad (3)$$

Subscripts it denotes i -th region in time t . Determinant $gGDP$ define as change in real output growth rate was calculated form nominal GDP, while using CPI from year 2000.

2.1 Differential version of Okun's law

In Table 3 and 4 we present the results of estimated models. Three variants of model were estimated: without specific impacts (M1) model with fixed (M2) and with random cross-sectional model effects (M3).

	M1	M2	M3
Constant β_0	1,16***	1,05***	1,1***
Okun's coefficient β_1	-0,21***	-0,21***	-0,22***
$-\beta_0/\beta_1$	5,52		5,06
R ²	0,531	0,577	0,495
Hausman test			2,449

Table 3 Results of estimated differential models, Own calculations

*** Parameter is significant on 1 % level of significance

Region	FEM Effect	Constant	$-\beta_0/\beta_1$
BA	0,75	1,80	8,58
TT	0,12	1,17	5,59
TN	0,08	1,13	5,36
NT	-0,41	0,64	3,04
ZI	0,17	1,22	5,82
BB	-0,24	0,81	3,85
PO	0,00	1,05	5,01
KE	-0,47	0,58	2,74

Table 4 Fixed effect (Model M2) for specific regions

The value of Okun's coefficient is in all three models about the same and indicates that every 1 % increase of real output, higher than ratio $(-\beta_0/\beta_1)$ is associated with a decrease in the unemployment rate by about 0,2 %. Table 4 shows also the values of constant/intercepts for each region, except fixed cross-sectional impact. In the last column, growth rates of output needed to keep the unemployment rate in each region are recorded. The results obtained are not identical. Among the regions with the lowest growth in output needed to ensure a stable unemployment rate belongs KE, NT, BB. Unemployment in all three above mentioned region has the highest value. The only exception is Prešov region. On the contrary, highest growth in output that has to be achieved is in Bratislava region, up above the level of 8.58%. The fall in unemployment in the Bratislava region can be expected only in case of such high regional growth.

2.2 Differential version in view of the crisis

Model from section 2.1 is extend with dummy variable1 for two reasons. The first reason is the need to eliminate the effects of the crisis in 2009 and the second is to obtain a lower variability models (M1, M2, M3). In this section, we estimate the model:

$$\Delta U_{it} = \beta_0 + \beta_1(gGDP_{it}) + \beta_2 D_{i,2009} + u_{it},$$

Where dummy variable $D_{i,2009}=1$ for year 2009 and the rest years are zero. Again, we estimate three variants of the modified model under above mentioned specification incorporated. The results are presented in Table 5 and 6.

	M4	M5	M6
Constant β_0	-0,12	-0,09	-0,26
Okun's coefficient β_1	-0,09***	-0,1***	-0,08***
β_2	3,77***	3,47***	3,96***
$-\beta_0/\beta_1$ (year 2009)	40,55556		46,25
$-\beta_0/\beta_1$ (other years)	-1,33333		-3,25
R ²	0,712	0,724	0,651
Hausman test			0,672

Table 5 The results of the modified differential version of the Okun's law, Own calculations

*** Parameter is significant on 1 % level of significance

Region	FEM effect	Constant	$-\beta_0/\beta_1$ (year 2009)	$-\beta_0/\beta_1$ (other years)
BA	0,60	0,51	29,61	5,09
TT	-0,03	-0,12	35,87	-1,17
TN	0,15	0,06	34,10	0,60
NT	-0,45	-0,54	40,12	-5,42
ZI	0,11	0,02	34,51	0,19
BB	-0,06	-0,15	36,15	-1,45
PO	0,00	-0,09	35,61	-0,91
KE	-0,32	-0,41	38,84	-4,14

Table 6 Fixed effect in model with dummy variable (model M5) and growth in output at constant unemployment

By incorporating dummy variables correcting the effects of the crisis in the economy, there was significant improvement of variability in all models. In both versions of regression analysis, Hausman test confirmed the model with random cross-sectional effects to be better. We consider these versions more appropriate, because of the higher variability in model with fixed effects (model M2 and M5).

Conclusion

While economic theory says about 2-3 % increase of output in order to achieve a reduction in the unemployment rate, the results of our analysis (in Table 4) show a different need for economic growth. Based on cross-sectional coefficients, we can conclude that relationship studied shows considerable disparity in the breakdown of the region. The highest value we obtained in the BA region, in order to decrease the unemployment rate in this region, the output must increase by more than 8,58% (Model M2). In regions with low unemployment (BA, TT, TN and PI) according to the theory of the Okun's law it would lead to further reduction of unemployment rate in the case of higher economic growth (5,36 to 8,58%). In contrast, in regions with high unemployment rates (KE, BB and NT), lower growth in output (2,74% to 3,85%) is sufficient. The lowest value of output growth 2,7% is required for maintenance of constant rate of unemployment in Košice region. This low value (compared to other regions) can be explained by high rate of work migration towards the west of the country. Prešov region differs from other regions and this could be explained by low effort of population to employ, as it is evident by the persistently high unemployment rate. In chapter 2.2 we have carried out an experiment with extension of the original model - difference version with dummy variable capturing the period of 2009, where there was a decrease of economy growth and the growth of unemployment. By estimating the model with dummy variable, we confirmed the opinion of Knotek (2007) according to which the value of the Okun's coefficient is unstable and sensitive to economic cycles. In our case, the integration of dummy variable into the model has led to reduction of Okun's coefficient by more than 50% \square (model versus M2 M5). Interpretation of gained values representing growth of output needed to ensure a constant level of unemployment is debatable. Despite the fact that the incorporation of dummy variable was realized in all cases (Model M4 - M6) and it has resulted to increase of explained variability, the values of parameters indicate a violation of fundamental theory Okun's law.

In 2009, growth rate of output would be required at 29,61 % (Bratislava region) and higher (Model M5, Table 6). Such high values could ensure stable unemployment rate in times of crisis. It can be concluded that if the economy grows and reaches only low levels of growth, unemployment is increasing i.e. businesses lay off workers and thus reducing the labor cost intensity and in order to meet production processes requirements for example will increase overtime hours worked. Interpretation of parameters $-\beta_0/\beta_1$ from recent years (last column of Table 6) is questionable, because the values obtained indicate that the constant unemployment rate can be achieved by decrease of output (TT region (-1,17), NT (-5,42), BB (-1,45), PO (-0.91) and KE (-4.14)).

Comparing our results with above mentioned authors we can conclude that on a regional basis we have achieved different results, none of the regions analysis coincides with aggregated variables for the whole Slovakia. It would certainly be interesting to implement the estimation of other versions of the Okun's law and to focus on business cycle in terms of crisis.

Acknowledgements: This work was supported by Grant VEGA 1/0595/11.

References

- [1] Buttinger (2013) FE312 Macroeconomics/2001 *Together Ahead!: Okun's Law Exhibied in the Slovak Republik*. [Online] Available: http://jamesbuttinger.com/FE312buttinger/Sample_A_papers_files/Together%20Ahead.pdf.
- [2] D'Apice, P. (2014) 'The Slovak labour market in the wake of the crisis: did Okun's law hold', *ICFIN Country Focus*, vol. 11, pp. 1-8.
- [3] Dujava, D. (2009) *Pesimista Okun*. Blog Národohospodárskej fakulty Ekonomickej univerzity v Bratislave, [Online] Available:

http://enhf.euba.sk/web2/index.php?option=com_content&task=view&id=504&Itemid=58 .

- [4] Economou, A. and Psarianos, I. N. (2013) ‘*Revisiting Okun’s Law in European Union Countries*’, Discussion paper series No. 13-05, University of Thessaly.
- [5] Hutengs, O. and Stadtmann, G. (2013) ‘*Don’t trust anybody over 30: Youth unemployment and Okun’s law in law in CEE countries*’, Discussion Paper No. 333, European University Viadrina Frankfurt.
- [6] Knotek, S. E. (2007) ‘*How Useful is Okun’s Law?*’, Kansas City: Federal Reserve Bank of Kansas City, [Online] Available:
<http://www.kc.frb.org/PUBLICAT/ECONREV/PDF/4q07Knotek.pdf>
- [7] Košta, J. et al. (2011) *Aktuálne problem trhu práce v Slovenskej republike po vstupe do Európskej menovej únie*, Ekonomický ústav SAV, Bratislava.
- [8] Lukáčik, M., Szomolányi, K., Lukáčiková, A. and Hančlová, J. (2010) ‘Long-run structural macroeconomic models of the Slovak and Czech economies’, *Quantitative Methods in Economics: Multiple Criteria Decision Making XV – Conference Proceedings*, The Slovak Society for Operations Research Conference, Smolenice, pp. 107-116.
- [9] Okun, A. M. (1962) ‘Potential GNP: Its Measurement and Significance’, *American Statistical Association, proceedings of the Business and Economics Statistics Section*, Alexandria, Virginia: American Statistical Association,
- [10] www.statistics.sk

Author’s address

Ing. Kvetoslava Surmanová, PhD.

University of Economics in Bratislava, Faculty of Business Informatics, Department of

Operations research and Econometrics

Dolnozemska 1/b, 852 35 Bratislava

Slovak Republic

email: kvetoslava.surmanova@euba.sk

Ing. Marian Reiff, PhD.

University of Economics in Bratislava, Faculty of Business Informatics, Department of

Operations research and Econometrics

Dolnozemska 1/b, 852 35 Bratislava

Slovak Republic

email: marian.reiff@euba.sk

SLOVAK ECONOMY AND INTEREST RATES SHOCKS

Karol Szomolányi, Martin Lukáčik and Adriana Lukáčiková

Abstract

Uribe and Schmitt-Grohé (2014) demonstrate that business cycles in emerging market economies are correlated with the interest rate that these countries face in international financial markets. This statement leads to question what fraction of business cycle fluctuations is due to movements in country interest rate. Uribe and Yue (2006) offer the specification of vector auto-regression model to quantify the macroeconomic effects of interest rate shocks. We use their specification to investigate the impact of world financial frictions on the Slovak economic activity in the period 2001 – 2011 and to confirm our assumption that overall economic activity had no impact on the financial world frictions for the economy as well. Furthermore, it appears the impact of production shocks on the economy.

Keywords: *VAR model, world financial frictions, interest shocks, interest spread*

JEL Classification: C32, G15, O16

AMS Classification: 91B64, 91G70

1 INTRODUCTION

The key models of real business cycle developed by Kydland and Prescott (1982) used the concept of shocks in total factor productivity. Their famous contribution led to development of microeconomic founded dynamic stochastic general equilibrium (DSGE) models that deliver quantitative predictions for short-run fluctuations in indicators that can be directly compared to actual data. In Slovakia the first well known representation of this class of models was the DSGE model of National Bank of Slovakia. By now, several models were published, e.g. Benkovič and Kupkovič (2013) or Horvát et al (2013) constructed simple models of Slovak economy. Their models were used to analyse real business cycles by Kupkovič (2013) or to investigate the impact of fiscal shocks on the business environment by Horvát et al (2013b).

Shock impacts on an economy could be also studied by other methodologies. For example we applied approach developed in Garratt, Lee, Pesaran and Shin (2006) to estimate long-run structure macro-econometric models of Slovak and Czech economies – see Lukáčik et al (2010). Strategy of Garratt and co-authors provides a practical approach to incorporating theoretic long-run relationships in a structural vector error correction model. This dynamic structure allows an easy estimation of impulse response functions. The summary of properties of this methodology is presented by Hančlová (2008).

In the small open developing economies – such as Slovak economy – different shocks can cause the economic fluctuations. Importance is the interest rate shocks caused by world financial frictions. Increasing interest rates faced by households and government of small open developing economy can cause a drop in economic activity caused by decreased mobility of capital. While shocks in total factor productivity have only a short-term impact, interest rate shocks may be theoretically more permanent and can affect the steady growth of the economy.

2 MODEL

It could be considered that the risk premium of developing country described by the difference in interest rates faced by the rest of the world and the interest rates faced by households and domestic government, $r^* - r$, is an endogenous variable. It depends on the ability of economic agents to efficiently use resources. Uribe and Yue (2006) proposed a specification of the vector autoregressive model (VAR), through which we can determine the size of the impact of interest rate shocks and recognize endogeneity or exogeneity of risk premium in the form:

$$\mathbf{A} \begin{pmatrix} y_t \\ i_t \\ tb_t \\ r_t^* \\ r_t \end{pmatrix} = \mathbf{B} \begin{pmatrix} y_{t-1} \\ i_{t-1} \\ tb_{t-1} \\ r_{t-1}^* \\ r_{t-1} \end{pmatrix} + \begin{pmatrix} \varepsilon_t^y \\ \varepsilon_t^i \\ \varepsilon_t^{tb} \\ \varepsilon_t^{r^*} \\ \varepsilon_t^r \end{pmatrix} \quad (1)$$

where y_t and i_t are expressed relative cyclical components of output and gross investment, tb_t is the share of trade on production, r_t^* is the real world interest rate and r_t is the real domestic interest rate in each investigation period t . The matrix \mathbf{A} is lower triangular matrix. We assume that interest rate shocks ($\varepsilon_t^{r^*}$, ε_t^r) will be reflected in production, investment and trade balance with a lag of one period. On the other hand, domestic shocks (ε_t^y , ε_t^i , ε_t^{tb}) have an immediate impact on financial markets. We assume that the world interest rate is exogenous, so apply $a_{4j} = b_{4j} = 0$ for all $j = 1, 2, \dots, 5$ and for $j \neq 4$, where a_{4j} and b_{4j} are elements in the 4th row and j -th column of matrix \mathbf{A} and \mathbf{B} , respectively.

3 DATA AND METHODOLOGY

3.1 Data

We estimated the parameters of the VAR specification (1). We used the real GDP, real gross capital formation, the share of trade in GDP obtained from the portal SLOVSTAT. The above figures are seasonally adjusted using procedures Tramo/Seats in EViews program. We obtained monthly series of average interest rates on 10-year German and Slovak government bonds traded on the secondary market from the website of the European Central Bank (ECB). From the portal EUROSTAT we received monthly series of annual inflation rate calculated using the harmonized consumer price index. We obtained quarterly series by averaging from the monthly data. We obtained the German and Slovak real interest rates by subtracting the natural logarithm of the inflation index expressed in the following year by the natural logarithm of the index expressed interest rates in each period.¹

Our analysis covers the period 2001 to 2011. Analyzed period is limited by disclose the extent of the time series of Slovakia interest rate. Due to stationarity, we used the first differences of the natural logarithm of GDP and gross capital formation, the first differences of the natural logarithm of the index terms of the share of trade in GDP and the first differences of the natural logarithm of the index expressed real interest rates. This period includes the first period of above-average output growth induced by the entry into the European Union and increased levels of foreign investment and later period of the financial crisis and the negative output growth. Furková (2013) explains the role of foreign investment and Chocholatá (2013) deals with the issue of the crisis in the environment of emerging economies.

3.2 Methodology

We estimated the unrestricted VAR model specification. Using Amisani and Giannini (1997) approach we estimated coefficients of matrix \mathbf{B} in (1). We estimated the parameters of restricted and unrestricted specifications. Using the logarithm of the maximum likelihood functions of both specifications we calculated the likelihood ratio statistics and verified the significance of restrictions in matrix \mathbf{A} . We calculate the impulse response functions and realize variance decomposition to quantify the short-term impact of shocks. Methodology of VAR models is explained particularly in Lukáčik and Lukáčiková (2013).

¹ Uribe and Yue (2006) adjusted domestic interest rate for foreign inflation. Also, we estimated a model in which the domestic interest rate is adjusted for German inflation. The results aren't significantly different, but the statistical properties of such a model are worse.

4 RESULTS

The tests showed the exogeneity of German interest rate, so $a_{4j} = 0$ for all $j = 1, 2, \dots, 5$ and for $j \neq 4$, where a_{4j} is an element in the 4th row and j -th column of matrix \mathbf{A} . Moreover, according to the z -statistics a_{51} , a_{52} and a_{53} are statistically insignificant. It follows that the domestic economic activity hadn't an immediate impact on Slovak risk premium. The interest rate for the government is immediately affected only by German interest rate.

Response to Structural One S.D. Innovations ± 2 S.E.

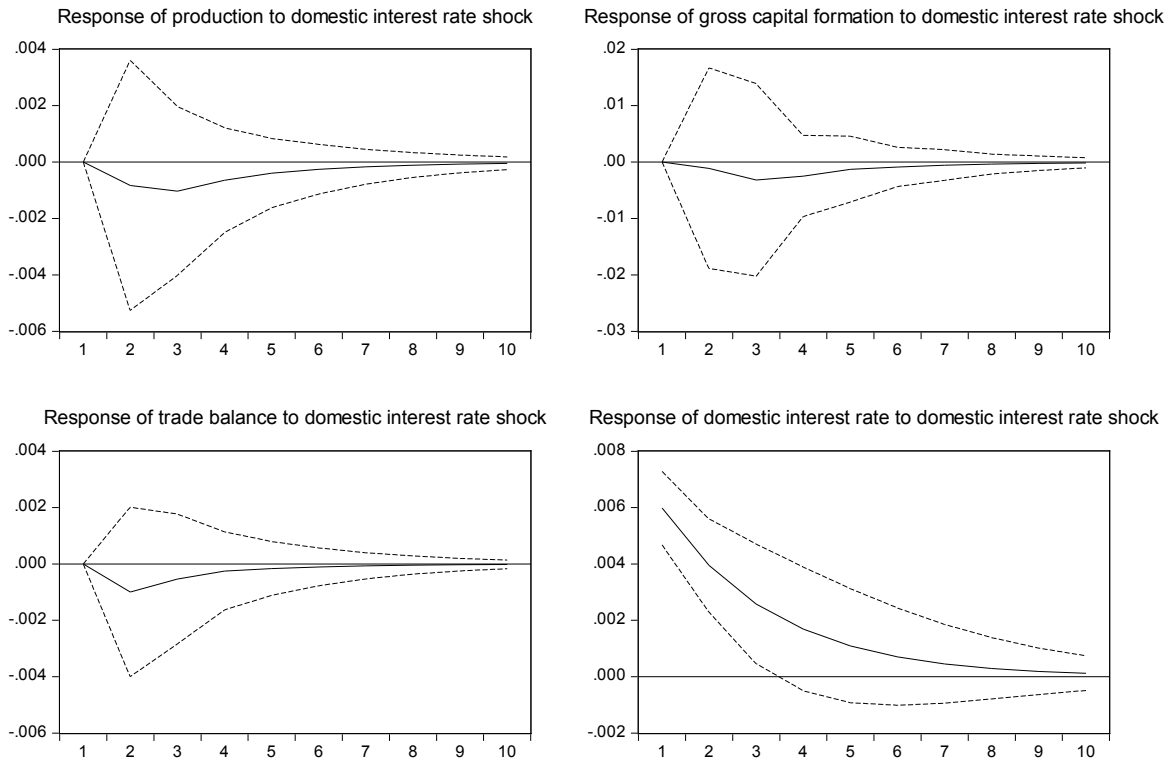

Figure 1 Impulse response functions to domestic interest rate shock

Response to Structural One S.D. Innovations ± 2 S.E.

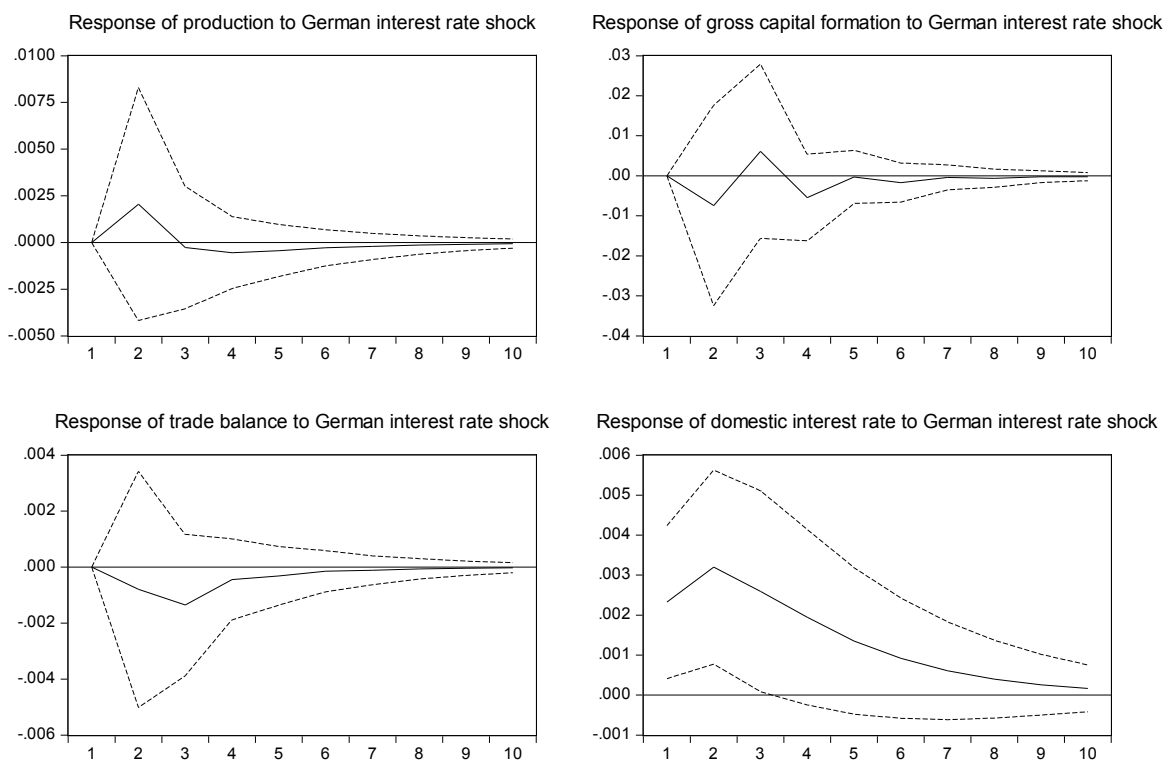

Figure 2 Impulse response functions to German interest rate shock

4.1 Impulse Response Functions

Figures 1-3 show the impulse response functions of GDP, gross capital formation, the share of trade balance to GDP and the real interest rate to Slovak interest rate shock (ε^s), German interest rate shock (ε^{r^*}) and productivity shock (ε^v), respectively. The solid line shows the impulse response function and the dotted lines are two standard deviation bands.

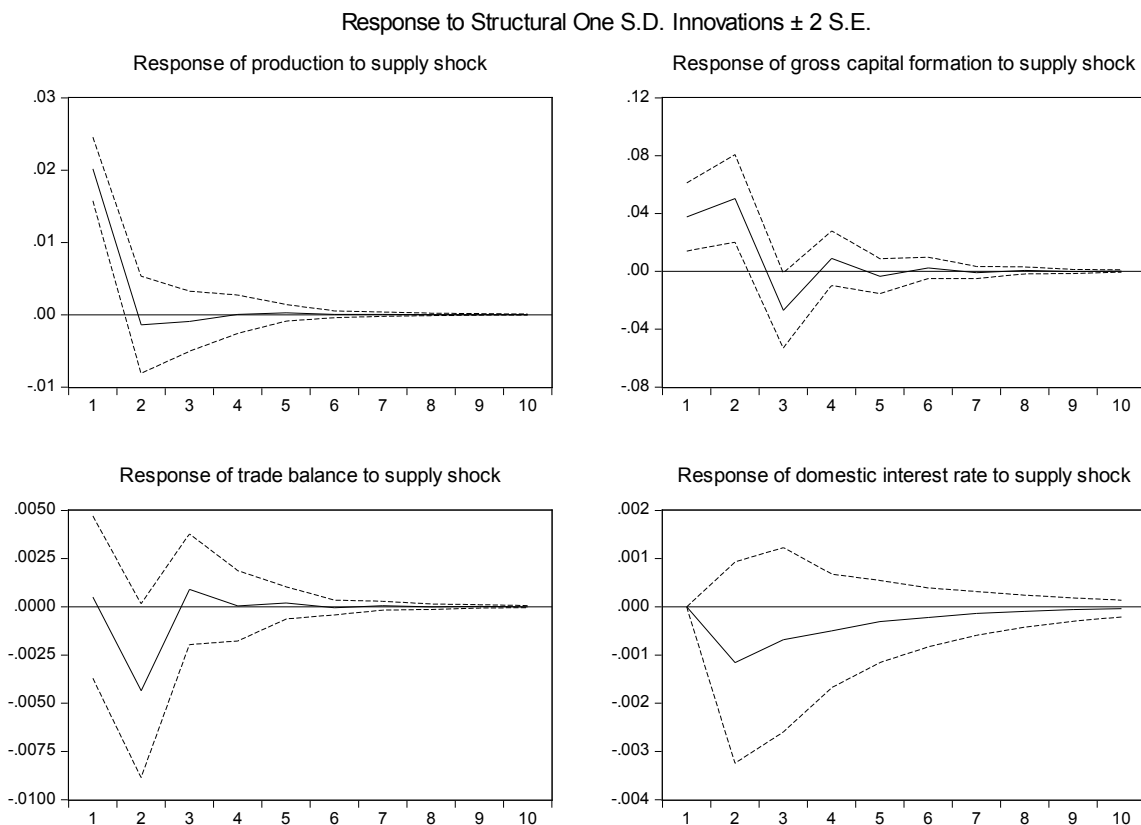

Figure 3 Impulse response functions to supply shock

Figure 1 shows that interest rate shocks hadn't any impact on the economic cycle in the Slovak economy in the period 2001 – 2011. As expected, production, gross capital formation and trade balance fell. Within the bands of two standard deviations may be considered by an increase in these variables. Their response is statistically insignificant.

Figure 2 shows that German interest rate shock had only statistically significant impact on domestic interest rate. Procyclicality of gross capital formation and acyclicity of trade balance can be observed from Figure 3. We state that domestic economic activity has no statistically significant impact on the value of the interest rate faced by the Slovak government.

4.2 Variance Decomposition

By variance decomposition we conclude that interest rate shocks had a small impact on our economy. This impact had only about 1.5 % share to changes in production and just over 2 % to changes in trade balance. Production shocks had the significant impact about 92 %. At the same time shocks in domestic economic activity had no significant impact on changes in domestic interest rate. Domestic shocks to these changes accounted for only about 2.5 %.

5 CONCLUSION

Our contribution doesn't reveal a significant impact of interest rate changes on the Slovak economy. We state that the restrictions on financial markets faced Slovak entities do not affect the economic growth. The rejection of the impact of interest rate shocks on economic speech and vice versa and the rejection of the impact of domestic economic expression on risk premium in

the period 2001 – 2011 doesn't necessarily mean that the economy of Slovakia cannot also face to common problems of emerging economy. This period for instance doesn't include the period of high interest rates in time of government of Prime Minister Mečiar.

Acknowledgements: This work was supported by the Grant Agency of Slovak Republic - VEGA, grant no. 1/0595/11 "Analysis of Business Cycles in the Economies of the Euro Area (with Regards to the Specifics of the Slovak Economy) Using Econometric and Optimization Methods"

References

- [1] Amisano, G. and Giannini, C. (1997) *Topics in Structural VAR Econometrics*, 2nd edition, Berlin: Springer-Verlag.
- [2] Benkovič, M. and Kupkovič, P. (2013) 'Dynamic Stochastic General Equilibrium Model of Small Open Economy', *Nové trendy v ekonometrii a operačným výzkumu – Conference Proceedings*, The Seminar of Department of Econometrics in Prague and Department of Operations Research and Econometrics in Bratislava, Prague, pp. 11-17.
- [3] Furková, A. (2012) 'Does Foreign Direct Investment Affect Economic Growth? Evidence from OECD Countries', *Quantitative Methods in Economics: Multiple Criteria Decision Making XVI – Conference Proceedings*, The Slovak Society for Operations Research Conference, Bratislava, pp. 56-61.
- [4] Garratt, A., Lee, K., Pesaran, M.H. and Shin, Y. (2006) *Global and National Macroeconometric Modelling: A Long-Run Structural Approach*, Oxford: Oxford University Press.
- [5] Hančlová, J. (2008) 'Comparative Properties of Structural Macroeconomic Modelling', *Quantitative Methods in Economics: Multiple Criteria Decision Making XIV – Conference Proceedings*, The Slovak Society for Operations Research Conference, Bratislava, pp. 70-75.
- [6] Horvát, P., König, B. and Ostrihoň, F. (2013) 'The Impact of the Technological Progress on the Development of the Slovak Economy – Neoclassical Approach', *Mathematical Methods in Economics 2013 – Conference Proceedings (part I)*, The Czech Society for Operations Research Conference, Jihlava, pp. 291-296.
- [7] Horvát, P., König, B. and Ostrihoň, F. (2013) 'The Basis for Modelling the Fiscal Shocks' Impact on the Business Environment of Slovakia', *Business Trends*, vol. 3, pp. 11-19.
- [8] Chocholatá, M. (2013) 'The Global Financial Crisis and Stock Returns: Evidence from the Czech Republic, Hungary and Poland', *Mathematical Methods in Economics 2013 – Conference Proceedings (part I)*, The Czech Society for Operations Research Conference, Jihlava, pp. 315-320.
- [9] Kupkovič, P. (2013) 'Medzinárodné reálne obchodné cykly v RBC modeloch', *EDAMBA 2013 – Conference Proceedings*, International scientific conference for doctoral students and young researchers, Bratislava, pp. 858-869.
- [10] Kydland, F. E. and Prescott, E. C. (1982) 'Time to Build and Aggregate Fluctuations', *Econometrica*, vol. 50, pp. 1345-1370.
- [11] Lukáčik, M. and Lukáčiková, A. (2013) *Vektorovo autoregresné modely a ich aplikácie v makroekonomickej analýze*, Bratislava: Publishing House Ekonóm.
- [12] Lukáčik, M., Szomolányi, K., Lukáčiková, A. and Hančlová, J. (2010) 'Long-run Structural Macroeconometric Models of the Slovak and Czech Economies', *Quantitative Methods in Economics: Multiple Criteria Decision Making XV – Conference Proceedings*, The Slovak Society for Operations Research Conference, Smolenice, pp. 107-116.
- [13] Uribe, M. and Schmitt-Grohé, S. (2014) *Open Economy Macroeconomics*. [Online], Available: <http://www.columbia.edu/~mu2166> [5 Mar 2014].
- [14] Uribe, M. and Yue, V. Z. (2006) 'Country Spreads and Emerging Countries: Who Drives Whom?' *Journal of International Economics*, vol. 69, pp. 6-36.

Author's address

Ing. Karol Szomolányi, PhD., doc. Ing. Martin Lukáčik, PhD., Ing. Adriana Lukáčiková, PhD.
University of Economics in Bratislava, Faculty of Business Informatics, Department of
Operations Research and Econometrics
Dolnozemska 1/b, 852 35 Bratislava
Slovak Republic
email: karol.szomolanyi@euba.sk

MATHEMATICAL METHOD FOR MULTICRITERIAL PROJECT SELECTION

*Vítězslav Ševčík, Jindřich Klapka,
Brno University of Technology*

Abstract

In this paper basic idea of method enabling a multicriterial selection of projects is given. The requirement for such a selection occurs, for example, when creating project portfolio of companies or ministerial departments. Main attention is dedicated to cases with a great number of projects and criterions. Here, it is also respected a hierarchical contingency relationship among candidate projects and synergistic effects in criterion functions and in resource requirements, as well as the possibility of the dialogue in the creation of weights of criterion functions.

Keywords: *project selection, decision support, multi-criterial optimization, mathematical programming*

JEL Classification: C44

AMS Classification: 90B50

1 INTRODUCTION

Computer support and mathematical modeling of project management consists (from the mathematical point of view) of the following basic stages (Klapka [8]): prognostic-planning stage, scheduling stage and the stage of analysis and chronicling.

One of the most important problems of prognostic-planning phase is the selection of projects by respecting appropriate criteria and by the limitations of the resources. In industrial enterprises and in the national economies there is often a need for a program system which would make it possible to carry out effectively multicriterial selection of hundreds of projects simultaneously, with tens of criterion functions including nonlinear ones, and tens of resources limitations with respect to the synergistic effects and the hierarchical interdependences between the projects. Since the tasks of this type usually belong to the “ill-defined” ones, it is advisable to use here the interactive dialogue approaches after the projects portfolio has been preliminarily optimized. Most often, the projects selected are the research and development (R&D) projects and the information systems projects. Some conditions for the formulation of the problems of this type are defined e.g. in Eilat, Golany and Shtub [3]. In Santhanam and Kyparisis [13] the problem is solved by means of the nonlinear goal programming. An excellent tool for the solution of the selection problems of great extent of input data is the idea of Stewart [14] who has created the scalarizing function by the modified reference point method, and for its optimization he has used a heuristic method of the effective gradient.

In [9] and [10] we have extended this approach to the possibility of utilizing criterion functions and constraints respecting synergistic effects of the second- and third-orders and hierarchical interdependencies between the projects. This work is based on the optimization by the modified method of effective gradient with the possibility of a dialogue improvement of the solution. The basic idea of the method is presented here.

The application of the presented decision support system proceeds under the cooperation with the Czech industrial enterprises and with other firms. The system is also applied for the teaching

process in the Technical University of Brno. Problems of the similar type are still considered by a number of authors, of whom e.g. Hsu [5], Wu, Lin, Kung, Lin [15], Yeh, Deng, Wibowo, Xu [16], Halouani et al. [4], and Litvinchev, López, Alvarez and Fernandez [11] introduced a fuzzyfication of some of the parameters. The lastly mentioned authors successfully managed effective optimization of portfolio of 25000 projects, while solving the projects selection as two-criteria selection problem, where one criterion is the quality of the portfolio, and the second criterion is a number of projects in the portfolio. Karsu and Morton [7] also solved a two-criteria problem, where one criterion is maximization of the total output and second criterion is minimization of an imbalance indicator. In our method, however, we solve a problem with tens of criterion functions with bivalent variables including polynomial ones and quotients of linear functions, tens of resources limitations and hundreds of projects.

2 PROBLEM FORMULATION

The following problem is solved: to choose some of the s projects into the portfolio. Let i be a number of the project ($i = 1, 2, \dots, s$). The projects belong to different categories (e.g. from the project type and the client type point of view). The categories need not be mutually exclusive. Let $S(k)$ be a set of the projects falling into category k ($k = 1, 2, \dots, q$). The goal of the solution is to find for all i the values of bivalent variables δ_i for which $\delta_i = 1$ if the project i is selected for the portfolio, and $\delta_i = 0$ in the opposite case. The selection should be made so that all requirements of the solution can be fulfilled, which includes the following:

1. To satisfy the resource constraints

$$\sum_{i=1}^s a_{ij} \delta_i - \sum_{i=1}^{s-1} \sum_{k=i+1}^s a_{ijk} \delta_i \delta_k + \sum_{i=1}^{s-2} \sum_{k=i+1}^{s-1} \sum_{l=k+1}^s a_{ijkl} \delta_i \delta_k \delta_l \leq b_j \quad (1)$$

where $b_j > 0$ is the total availability of resource j ($j = 1, 2, \dots, m$), $a_{ij} \geq 0$ is the amount of resource j required by project i , $a_{ijk} \geq 0$ is the amount of resource j shared by projects i and k , a_{ijkl} is a real number depending on the amount of resource j shared by projects i , k , and l . In some cases, this coefficient can be negative. In general it holds that, $a_{ij} \geq a_{ijk}$, $a_{kj} \geq a_{ijk}$, $a_{ijk} \geq a_{ijkl}$, $a_{ijl} \geq a_{ijkl}$, $a_{kjl} \geq a_{ijkl}$ for all i, k, l . In case of the absence of synergistic effect in resource sharing it holds $a_{ijk} = 0$, $a_{ijkl} = 0$.

2. To satisfy contingency constraints

$$\sum_{m \in A_i} \delta_m \geq |A_i| \delta_i \quad \text{for all } i \in H, \quad (2)$$

where H ($H \subset \{1, 2, \dots, s\}$) is a set of all projects which are contingent upon the implementation of other projects, A_i ($A_i \subset \{1, 2, \dots, s\}$) is a set of all projects upon the implementation of which the project i is contingent. $|A_i|$ is the number of elements in the set A_i .

3. To satisfy the directive constraints

$$\delta_i = \begin{cases} 1 & \text{for } i \in B \quad (B \subset \{1, 2, \dots, s\}) \\ 0 & \text{for } i \in D \quad (D \subset \{1, 2, \dots, s\}) \end{cases}, \quad (3)$$

where sets B , D are mandated due to internal and external restrictions.

4. To satisfy the restrictions for mutually exclusive projects: for some i, j ($i, j \in \{1, 2, \dots, s\}$), can be required: if $\delta_i = 1$, then $\delta_j = 0$, and if $\delta_j = 1$, then $\delta_i = 0$ (e.g. in case when two projects represent alternative levels of activity on the same essential problem).

5. To obtain the highest possible values of criterion functions of gain (benefit) constraints

$$z_j = \sum_{i=1}^s c_{ij} \delta_i + \sum_{i=1}^{s-1} \sum_{k=i+1}^s c_{ijk} \delta_i \delta_k + \sum_{i=1}^{s-2} \sum_{k=i+1}^{s-1} \sum_{l=k+1}^s c_{ijkl} \delta_i \delta_k \delta_l \quad (j=1,2,\dots,p), \quad (4)$$

where $c_{ij} \geq 0$ is the j th benefit derived from implementing project i alone, $c_{ijk} \geq 0$ is the additional j th benefit derived from implementing projects i and k together, and $c_{ijkl} \geq 0$ is the additional j th benefit derived from implementing projects i , k and l together. Comments:

(a) In a similar way it is possible to formulate a cost-related objective, a negative value of which is maximized by approaching to zero.

(b) The special case when $c_{ijk} = 0$, $c_{ijkl} = 0$ corresponds to the absence of synergistic effect of benefit. Under the simplifying assumptions concerning the additivity of risk (Jain et al., [6]), the risk of the set of projects selected may be expressed by the first term in (4) where c_{ij} is now the risk of implementing project i . In this case, we minimize the total risk of portfolio of the selected projects by maximizing

$$\left\{ - \sum_{i=1}^s c_{ij} \delta_i \right\}.$$

6. To obtain the smallest possible deviation of Stewart function

$$\Phi_k = \frac{\sum_{i \in S(k)} \mu_i \delta_i}{\sum_{i=1}^s \mu_i \delta_i} \quad (k=1,2,\dots,q), \quad (5)$$

from its ideal value π_k (see the above definition of project categories) where μ_i is the cost related to the project i (or e.g. total manpower used by project i). It appears that $\Phi_k \in [0;1]$, $\pi_k \in [0;1]$. Let us assume that for at least one i it holds that $\delta_i = 1$.

3 ARRANGEMENT OF THE FORMULATION

Let us choose ‘‘asymmetric distance’’ of Φ_k from π_k , denoted by $\|\Phi_k - \pi_k\|$, in such a way that its value belongs to interval $[0;1]$ and that for $\Phi_k = 1 \wedge \pi_k \neq 1 \vee \Phi_k = 0 \wedge \pi_k \neq 0$ it holds that $\|\Phi_k - \pi_k\| = 1$ and that for $\Phi_k = \pi_k$ it holds that $\|\Phi_k - \pi_k\| = 0$. For this purpose we define

$$\|\Phi_k - \pi_k\| = \begin{cases} 0 & (\Phi_k = \pi_k) \\ \frac{\Phi_k - \pi_k}{l(\Phi_k - \pi_k) - \pi_k} & (\text{otherwise}) \end{cases},$$

where unit-step function $l(x) = 0$ for $x \leq 0$, $l(x) = 1$ for $x > 0$. This means that maximal possible deviations of Φ_k on either side of π_k are equally important.

Then, it is possible to reformulate the problem in the following way:

‘‘max’’ z_j ($j=1,2,\dots,p+q$).

We solve this problem under constraints (1)–(3), where the criterion functions z_j ($j=1,2,\dots,p$) are given in (4) with signs of individual terms possibly changed with respect to Comments 5a and 5b. The criterion functions z_{p+k} ($k=1,2,\dots,q$) are now defined by

$$z_{p+k} = -\|\Phi_k - \pi_k\| = \begin{cases} 0 & (\Phi_k = \pi_k) \\ \frac{\pi_k - \Phi_k}{l(\Phi_k - \pi_k) - \pi_k} & (\text{otherwise}) \end{cases}, \quad k=1,2,\dots,q. \quad (6)$$

4 OPTIMIZATION AND DIALOGUE

In Santhanam and Kyparisis [13] a project selection problem is solved with criterion functions of type (4), resource constraints (1) and contingency constraints (2) for 14 projects ($s = 14$) with accounting for interdependences (type of benefit, cost, resources sharing, and contingency) of up to the third-order by means of the method based on the goal programming. Decision support system presented here by us enlarges the capabilities of Santhanam's system by the possibilities of solving the problems of more greater extent of input data, utilizing also the balance ratio functions of (5) type, then by the dialogue that makes it possible to solve also the ill-defined problems and by the utilization of the preliminary realistically assessed desired levels of individual criterion functions. With respect to this dialogue, it is not necessary to use accurate methods for optimization, but it is possible to use a heuristic method which makes it possible to enlarge the extent of input data of the solved problem.

For each criterion function z_j we determine the upper bound I_j (in the way of solving an appropriate monocriterial maximization problem with the criterion function z_j), and analogically the lower bound N_j of its optimum value through monocriterial minimization problem. It is very easy to find the bounds for each criterion function. At the same time, the user determines a realistically assessed desired level (reference level) R_j of each z_j . We require

$$N_j \leq R_j \leq I_j. \quad (7)$$

In case when the user is not able to order R_j , we can set the initial reference level as follows:

$$R_j = \frac{I_j + N_j}{2}.$$

The problem is now transformed to minimizing the scalarizing function

$$\sigma = \sum_{j=1}^{p+q} \left(\frac{I_j - z_j}{I_j - R_j} \right)^h$$

for some $h > 0$ under conditions (1)–(4), (6). In the system presented here, a method of effective gradient (Stewart, [14]), generalized by us for the case of the synergistic effects and hierarchical interdependences of projects, is used for the solution of this minimization problem. The selection $h = 4$ as a compromise between the sensitivity of the method and time and rounding off numerical difficulties proved to be equally right for us and the above-mentioned author. By means of this solution optimal values δ_i for all $i = 1, 2, \dots, s$ are determined, which define a portfolio of projects selected.

The main idea of our generalized effective gradient method is as follows:

At the beginning of the process of solution, we select $\delta_i = 1$ for all $i = 1, 2, \dots, s$ (except for a case when some projects must not take place simultaneously, in which case an arbitrary selection can be made between these). Then we calculate

$$u_j = \sum_{i=1}^s a_{ij} \delta_i - \sum_{i=1}^{s-1} \sum_{k=i+1}^s a_{ijk} \delta_i \delta_k + \sum_{i=1}^{s-2} \sum_{k=i+1}^{s-1} \sum_{l=k+1}^s a_{ijkl} \delta_i \delta_k \delta_l$$

for all $j = 1, 2, \dots, m$, which is the amount of the j th resource requested by those projects that were incorporated in the portfolio. In case that a resource constraint is not satisfied, then for each i for which $\delta_i = 1$, we define $\Delta_i \sigma$ as an increase of function σ caused by dropping project i from the portfolio. For all such i we calculate

$$P_i = \Delta_i \sigma \frac{\sqrt{\sum_j (u_j - b_j)^2}}{\sum_j A_{ij} (u_j - b_j)},$$

Where

$$A_{ij} = a_{ij} - \sum_{k=1,2,\dots,i-1,i+1,i+2,\dots,s} a_{ijk} \delta_k + \sum_{k=1,2,\dots,i-1,i+1,i+2,\dots,s-1} \sum_{l=k+1,k+2,\dots,i-1,i+1,\dots,s} a_{ijkl} \delta_k \delta_l$$

is the amount of the j th resource consumed due to the implementation of the i th project. P_i is an effective gradient of the scalarizing function σ . The sums in the relation for P_i are realized for all $u_j \geq b_j$ only. The project giving the expression P_i a minimum value will be dropped from the portfolio.

This step repeats until all resource limitations are fulfilled. Analogically, in a backward course, we introduce into portfolio a maximal number of projects that do not violate any resource constraint.

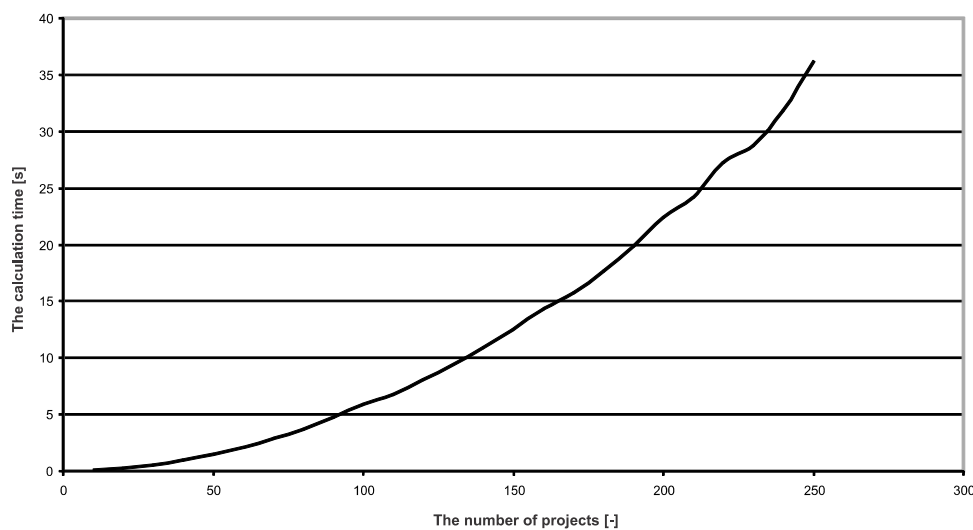

Figure 1 Graph of the dependence of the calculation time on the number of projects ($m = 50$, $p = 20$, $q = 20$).

The dialogue between the user of the system and the person solving the problem, accomplished after the introductory optimization, influences also the value of reference levels R_j in an adaptive way, and thus also the weights of components of the scalarizing function for the purposes of potential future reoptimization of portfolio.

This dialogue is described in [10]. The dependence of the calculation time for optimization on the number of projects is given in Figure 1. Some authors have solved this problem in connection with planning of the projects. For example in Medaglia, Hueth, Mendieta, Sefair [12] selection and planning are simultaneously considered. Carazo et al. [1], [2] applied an evolutionary metaheuristic method for project selection.

5 CONCLUSION

We tried to perfect current situation in using project management in production and manufacturing by making a system of decision support provided with a dialogue regime for large problems of R&D and information systems projects selection. Stewart's idea of the special scalarizing function for cost and balance criteria functions and its optimization by effective gradient method is generalized here, involving synergistic effects of second- and third-order in benefit and cost criterion functions, and in resources requirements respecting resource sharing, and hierarchical contingency relationships among candidate projects. The system is equipped by

a possibility of the use of balance criterion functions and of the use of the preliminarily realistically assessed desired levels of individual criterion functions. The newly constructed system makes the integrated application of these elements and functions possible.

Acknowledgements: This work was supported by research project of BUT IGA No. FSI-S-11-31.

References

- [1] Carazo, A.F., Contreras, I., Gómez, T. and Pérez, F. (2012), 'A project portfolio selection problem in a group decision-making context', *Journal of Industrial and Management Optimization*, vol. 8, pp. 243–261. doi:10.3934/jimo.2012.8.243.
- [2] Carazo, A.F., Gómez, T., Molina, J., Hernández-Díaz, A.G., Guerrero, F.M. and Caballero, R. (2010) 'Solving a comprehensive model for multiobjective project portfolio selection', *Computers & Operations Research*, vol. 37, pp. 630–639. doi:10.1016/j.cor.2009.06.012.
- [3] Eilat, H., Golany, B. and Shtub A. (2006) 'Constructing and evaluating balanced portfolios of R&D projects with interactions: A DEA based methodology', *European Journal of Operational Research*, vol. 127, no. 3, pp. 1018–1039. doi:10.1016/j.ejor.2004.12.001
- [4] Halouani, N., Chabchoub, H. and Martel, J.M. (2009) 'PROMETHEE-MD-2T method for project selection', *European Journal of Operational Research*, vol. 195, pp. 841–849. doi:10.1016/j.ejor.2007.11.016
- [5] Hsu, K.-H. (2005) 'Using Balanced Scorecard and Fuzzy Data Envelopment Analysis for Multinational R&D Project Performance Assessment' *Journal of American Academy of Business*, vol. 7, no. 1, pp. 189–196.
- [6] Jain, H.K., Tanniru, M.R. and Fazlollahi, B. (1991) 'MCDM Approach for Generating and Evaluating Alternatives in Requirement Analysis', *Information System Research*, vol. 2, no. 3, pp. 223–239. doi:10.1287/isre.2.3.223.
- [7] Karsu, Ö. and Morton, A. (2014) 'Incorporating balance concerns in resource allocation decisions: A bi-criteria modelling approach', *Omega*, vol. 44, pp. 70–82. doi:10.1016/j.omega.2013.10.006
- [8] Klapka, J. (1994) 'Contemporary state of mathematical modelling in project management' *Modelling, Measurement and Control D 9*, vol. 3, pp. 43–63.
- [9] Klapka, J. and Pinos, P. (2002) 'Decision support system for multicriterial R&D and information systems projects selection' *European Journal of Operational Research*, vol. 140, no. 2, pp. 434–446. doi:10.1016/S0377-2217(02)00081-4.
- [10] Klapka, J., Pinos, P. and Sevcik, V. (2013) 'Multicriterial Project Selection'. In: *Handbook of Optimization, ISRL 38* (Zelinka et al., eds.), Springer, Berlin Heidelberg, pp. 245–261. doi:10.1007/978-3-642-30504-7_10
- [11] Litvinchev, I.S., López, F., Alvarez, A., and Fernandez, E. (2010) 'Large-Scale Public R&D Portfolio Selection by Maximizing a Biobjective Impact Measure', *IEEE Transactions on Systems, Man, and Cybernetics*, vol. 40, no. 3, pp. 572–582. doi:10.1109/TSMCA.2010.2041228.
- [12] Medaglia, A.L., Hueth, D., Mendieta, J.C. and Sefair, J.A. (2008) 'A multiobjective model for the selection and timing of public enterprise projects', *Socio-Economic Planning Sciences*, vol. 42, pp. 31–45. doi:10.1016/j.seps.2006.06.009.
- [13] Santhanam, R. and Kyparisis, J. (1995) 'Multiple criteria decision model for information system project selection'. *Computers and Operations Research*, vol. 22, no. 8, pp. 807–818. doi:10.1016/0305-0548(94)00069-K.
- [14] Stewart, T.J. (1991) 'A multi-criteria decision support system for research and development project selection, *Journal of the Operational Research Society*, vol. 42, pp. 17–26. doi:10.1057/jors.1991.3.

- [15] Wu, W.Y., Lin, C., Kung, J.Y. and Lin, C.T. (2007), 'A new fuzzy TOPSIS for fuzzy MADM problems under group decisions', *Journal of Intelligent and Fuzzy Systems*, vol. 18, no. 2, pp. 109–115.
- [16] Yeh, C.-H., Deng, H., Wibowo, S. and Xu, Y.: Multicriteria Group Decision Support for Information Systems Project Selection (2009). In: *Next-Generation Applied Intelligence* (Chien, B.-C., Hong, T.-P., Chen, S.-M, and Ali, M., eds.), Springer, Heidelberg, 2009, pp. 152–161. doi:10.1007/978-3-642-02568-6_16.

Author's address

doc. RNDr. Jindrich Klapka, CSc., Ing. Vitezslav Sevcik
Brno University of Technology, Faculty of Mechanical Engineering, Department of Applied
Computer Science
Technicka 2896/2, 616 69 Brno
Czech Republic
email: klapka@fme.vutbr.cz, sevcik@fme.vutbr.cz

AN EXAMPLE OF RENEGOTIATION-PROOF EQUILIBRIUM WITH PRODUCT INNOVATION

*Lubica Šimková,
Comenius University in Bratislava*

Abstract

We analyze infinite horizon interaction between producers of inputs and buyers of these inputs. The model has the form of difference game with discounting of future single period profits. Producers of inputs can innovate their products in period zero. Such innovations affect parameters of production functions of firms who buy these inputs over infinite time horizon. The solution concept in our model is renegotiation-proof equilibrium. It is a subgame perfect equilibrium with the additional property that there does not exist a subgame in which the grand coalition can increase payoff of each of its members by a coordinated deviation. We illustrate its existence in an example of the analyzed game with two producers of inputs and two final producers buying these inputs.

Keywords: *difference game, product innovation, renegotiation-proof equilibrium, subgame perfect equilibrium.*

JEL Classification: C73, D43

AMS Classification: 91A20

1 INTRODUCTION

In our work we analyze infinite repetition of interaction between firms on both sides of a market. On one side there are producers of inputs and on the other side there are buyers of these inputs. We focus on innovations of inputs which can be made by producers in a period zero. The model has the form of a difference game with discounting of future single period profits. If innovations are made they affect parameters of production functions of analyzed firms who buy inputs over infinite time horizon. The cooperation on both sides of a market is helpful for the final consumer. In our example we illustrate the existence of a renegotiation-proof equilibrium. It is a subgame perfect equilibrium with the additional requirement that the grand coalition cannot strictly Pareto improve the vector of payoffs of its members in any subgame. Thus, it is a stronger concept than both weak renegotiation-proof equilibrium and strong renegotiation-proof equilibrium developed by Farrell and Maskin [1].

2 ANALYZED EXAMPLE

In our model we analyze interactions between a finite number of producers and a finite number of buyers. In a such market each producer makes a contract proposal to each buyer as well as each buyer makes a contract proposal to each producer. A contract is concluded if and only if the sellers and the buyers proposals coincide. (See Horniaček [2] for further details of such contractual arrangements). In our example we analyze market consisting of two producers of inputs on one side of the market ($J = \{1,2\}$) and two buyers of these inputs, who produce final goods from them, on the other side of the market ($I = \{3,4\}$). We observe how the innovation of inputs in period zero affects quantities and prices of final goods over the rest of the infinite time horizon of the model.

For each producer $j \in J$ cost function has the form $c_j(y_j) = 10y_j + 50$. For each buyer $i \in I$ his total costs consists of expenditures on inputs and additional costs (e.g. labor cost, maintenance cost) expressed by function $c_i(x_i) = \sum_{j \in J} x_{ji} + 20$, where x_{ji} is the quantity of input produced by firm j used by buyer i . Every $i \in I$ produces one type of good and its production function has the form $f_i(x_{1i}, x_{2i}) = \min\{(1 + \Delta_1)x_{1i}; (1 + \Delta_2)x_{2i}\}$, where Δ_j is the intensity of product innovation of input produced by firm $j \in J$. The inverse demand functions for the buyers' outputs, $P_3: R_+^2 \rightarrow R_+$ and $P_4: R_+^2 \rightarrow R_+$, have the form $P_3(q_3, q_4) = \max\{42 - 2q_3 + q_4, 0\}$ and $P_4(q_3, q_4) = \max\{42 + q_3 - 2q_4, 0\}$, where q_3 and q_4 , respectively, are outputs of final goods. The cost of product innovation by firm $j \in J$ with intensity Δ_j is $\frac{1}{5 - \Delta_j} - \frac{1}{5}$. Thus, intensity of

product innovation is from the interval $[0, 5)$. In period zero firms one and two make decisions on intensity of innovations of their products. Then, in periods numbered by natural numbers, firms one and two conclude contracts for delivery of inputs with firms three and four, these contracts are carried out and production and sale of final goods takes place.

We analyze sustainability of intensities of product innovations and subsequent traded quantities over infinite horizon that maximize the sum of average discounted profits of all firms. We have maximized this sum separately for each coalition capable of producing ($\{1, 2, 3\}$, $\{1, 2, 4\}$, $\{1, 2, 3, 4\}$).

We denote the analyzed game with discount factor $\delta \in (0, 1)$ (common for all firms) by $\Gamma(\delta)$. S_k is the set of pure strategies of firm $k \in J \cup I$ in it. For each $j \in J$ each $s_j \in S_j$ assigns to the empty history a nonnegative intensity of product innovation by firm j and to each history leading to period $t \in N$ a contract proposal made to each buyer. For each $i \in I$ each $s_i \in S_i$ assigns to each history leading to period $t \in N$ a contract proposal made to each producer. We let $S = \prod_{k \in I \cup J} S_k$. For each $k \in I \cup J$ function $\pi_k: S \rightarrow R$ is firm k 's payoff function in game $\Gamma(\delta)$. (We do not include discount factor among arguments of payoff function.) It assigns to each profile of pure strategies in $\Gamma(\delta)$ k 's average discounted profit in it. Restrictions of strategies, sets of strategies, and payoff functions to a subgame following a history h are indicated by subscript (h).

Definition 1: A profile of pure strategies $s^* \in S$ is renegotiation-proof equilibrium in $\Gamma(\delta)$ if (i) there does not exist period $t \in N \cup \{0\}$, history h leading to it, producer $j \in J$, and his strategy $s_j \in S_{j(h)}$ such that $\pi_{j(h)}(s_j, s_{-j(h)}^*) > \pi_{j(h)}(s_h^*)$, (ii) there does not exist period $t \in N$, history h leading to it, buyer $i \in I$, and his strategy $s_i \in S_{i(h)}$ such that $\pi_{i(h)}(s_i, s_{-i(h)}^*) > \pi_{i(h)}(s_h^*)$, (iii) there does not exist period $t \in N \cup \{0\}$, history h leading to it, and strategy profile $s \in S_{(h)}$ such that $\pi_{k(h)}(s) > \pi_{k(h)}(s_h^*)$ for each $k \in J \cup I$.

This concept of renegotiation-proof is stronger than those introduced by Farrell and Maskin [1] because it does not impose restrictions on strategy profiles to which the grand coalition can renegotiate.

3 EXISTENCE OF RENEGOTIATION-PROOF EQUILIBRIUM

Proposition 1: *There exists discount factor $\underline{\delta} \in (0,1)$ such that for each $\delta \in [\underline{\delta},1)$ game $\Gamma(\delta)$ has a renegotiation-proof equilibrium.*

Proof. First, we have made computations for discount factor $\delta = 0.6$. In this case in each period $t \in N$, the sum of average discounted profits of all firms is maximized when the coalition of all four firms forms. This gives output of each final good equal to 19.094, production of each input equal to 6.6183, each producer of final good uses amount 3.3092 of each input, the sum of single period profits of all firms equals 729.13. Intensity of product innovation of each input is 4.7701. We have verified by computations not reported here (available from the author at request) that for any discount factor $\delta \in [0.6,1)$ the sum of every discounted profits of all firms is also maximized when the grand coalition forms and punishments analogous to those described below are still applicable. Therefore, we describe here only renegotiation-proof equilibrium for $\delta = 0.6$.

The equilibrium strategy profile is as follows. In period zero each producer of input carries out product innovation of intensity 4.7701. In each period $t \in N$, contracts are concluded for delivery of amount of 3.3092 of each input to each final producer for price 24. This leads to output 19.94 of each final good, single period profit 42.656 for each producer of input and profit 251.91 for each producer of final good. If there is no deviation in period zero, a unilateral single period deviation by any player does not change the prescribed behavior in the following period. If there is a unilateral deviation in period zero, in the following periods the grand coalition trades quantities of inputs that maximize the sum of single period profits of its members but prices of inputs are from the interval $[10,23.5]$, which is set in a such way that, taking into account fixed costs, all firms make positive profits.

As already noted, this strategy profile satisfies condition (iii) of definition of renegotiation-proof equilibrium. It is easy to see that no producer of final good can gain by unilateral deviation. (He would be left without at least one input and produce nothing.) Hence, condition two of the Definition 1 is also satisfied. If the producers of inputs stick to prescribed intensities of innovations in period zero, they cannot gain by a unilateral deviation in any following period. (They sell for price exceeding their marginal costs.) If one of them deviates in intensity of product innovation in period zero, the deviator is punished in the following periods by decrease of price of its product by at least half of a monetary unit. We have verified that the maximization of single period profits of all four firms leads to quantities of inputs no less than 2.4306. Thus, for discount factor $\delta \in [0.6,1)$ a producer of input loses by such deviation in period zero. Hence, condition one of the Definition 1 of a renegotiation-proof equilibrium is also satisfied.

Q.E.D.

4 CONCLUSION

We have shown that collusion between firms – in both traded quantities and intensities of product innovation - on both sides of the market can be sustained in infinite horizon in a renegotiation-proof equilibrium. Participation of firms on both sides of the market avoids the problem of weakly Pareto efficient punishments immune to unilateral deviations that arise in collusion between firms on only one side of the market. From the game theoretic point of view it is noteworthy that our results hold also for decisions on intensities of product innovation which are irreversible in our model. From the economic point of view it would be useful to compare equilibrium considered here with behavior based on infinite repetition of static equilibrium in traded quantities. We hope to do this in future paper.

Acknowledgements: This work was supported by grants VEGA 1/0181/12 and VEGA 1/0197/13.

References

- [1] Farrell, J. and Maskin, E. (1989) 'Renegotiation-Proof Equilibrium: Reply', *Journal of Economic Theory*, vol. 49, pp. 376-378.
- [2] Horniaček, M. (2011) 'Cooperation and Efficiency in Markets', *Lecture Notes in Economics and Mathematical Systems*, no. 649, Berlin – Heidelberg., pp. 49.

Author's address

Mgr. Ľubica Šimková
Comenius University, Faculty of Social and Economic Sciences, Department of Public Policy and Economics
Mlynské luhy č. 4, 921 05 Bratislava
Slovak Republic
Email: lubica.simkova@fses.uniba.sk

MULTI-CRITERIA OPTIMIZATION OF DISTRIBUTION SYSTEM STRUCTURE – COMPARISON OF SELECTED METHODS AND THEIR EFFECTIVENESS

*Dusan Teichmann, Michal Dorda, Martin Ivan,
VŠB – Technical University of Ostrava*

Abstract

If we want to plan and control distribution logistics system optimally, it is necessary to be concerned with an optimal structure of the distribution system. Optimization of the distribution system structure may bring an increase of operational process effectiveness and enables to fulfil demands of its users more effectively. However, such problem is not often the problem with only individual optimization criterion but we must take into account more criteria when solving the problem. It is very important to choose the optimization criteria such that they can represent interests of the individual users and must be easily quantifiable as well. This is often very difficult because the interests of the distribution system users are varied and possibilities of their quantification are very limited. In the paper the problem about the structure of the distribution systems is formulated as an optimization problem with two criteria. The proposed model is solved using different methods and the paper includes a comparison of achieved results.

Keywords: distribution systems, mathematical modelling, logistics

JEL Classification: C61

AMS Classification: 90C05

1 INTRODUCTION – MOTIVATION TO SOLVE THE TASK

Logistics is a scientific discipline that has its main target to ensure goods are delivered with corresponding costs, in the corresponding time and with requested quantity and quality to a desired place [9]. Each logistical chain being operated on the market must fulfil such requirements. Usually, the costs that are expended on satisfying customer's requests stand on the first place. If the costs of the logistical chain are too high there are only few customers who are interested in using such logistical chain. Therefore minimizing the costs of the logistical chain is a logical demand. However, minimizing the costs need not be the sole customer's demand. The customer can often request to meet an additional factor – so-called reliability of delivery [9]. Reliability of delivery can be expressed with the probability that the delivery time will be satisfied. Therefore the authors think that it is important to take this probability into consideration when planning for example the structure of the distribution system.

2 STATE OF THE ART

A lot of publications discuss the problem of cost minimization when designing the distribution systems. For solving such type of the optimization task following methods are usually employed: linear programming [7], heuristic methods [4] or [7] or cluster analysis and their mutual combinations [8]. These methods offer effective tools for designing the distribution system structure with minimal costs. Reliability of the distribution systems is discussed for example in publications [4], [11] and [12]. The publications are focused on a reliability calculation for examples when some crisis situations (accidents etc.) occur in the distribution system. The publications offer some tools enabling the calculation of the probability that a shipment is delivered in time.

3 METHODOLOGY

Optimization tasks with multiple criteria can be solved using several approaches. Most often, the following methods are used: scalarization methods, sequential optimization according to individual criterions [1], the STEM method [3] and the method based on a cumulated criterion.

The scalarization method can be used for examples if we are able to transform all the criteria into a common quantity (for example the costs). Because the scalarization method transforms the multi-criteria task into the single-criterion task, we will not employ this method in the paper.

4 MATHEMATICAL MODEL

Let a primary source be given, a set of customers J and a set of places I from which the customers can be supplied. The customers can be supplied also from the primary source. For each customer $j \in J$ his request b_j per a year is given. Distances d_{ij} among the places $i \in I$ and the customers $j \in J$ are known. Further we know distances d_{0i} among the primary source and each place $i \in I$ and distances e_{0j} among the primary source and each customer $j \in J$. For each place $i \in I$ where a warehouse can be situated its capacity q_i and fixed running costs f_i per year are given. For the primary source we presume that it has the capacity enough to satisfy the requests of all the customers. Supplying is carried out using two types of vehicles that differs in the capacity and the costs for covering the distance of 1 km. The vehicle that supplies the places and the customers from the primary source has the capacity k_1 and the costs c_1 for covering the distance of 1 km; the vehicle that supplies the customers from the places has the capacity k_2 and the costs c_2 for covering the distance of 1 km. Let us presume the customers' requests are given as multiples of the vehicle capacities. The probability that the shipment will be delivered to the customer $j \in J$ from the primary source in time is denoted p_{0j} ; the probability that the shipment will be delivered to the customer $j \in J$ from the warehouse situated in the place $i \in I$ is denoted p_{ij} . We would like to make a decision about how to supply the customers so that the total running costs of the whole distribution system are minimal and the minimal value of the probability that the shipment is delivered in time is maximal. In order to do such decision we must define following variables – a binary variable x_{ij} that models the decision about supplying the customer $j \in J$ from the place $i \in I \cup \{0\}$, a binary variable y_i modelling whether the warehouse should be situated in the place $i \in I$ or in the primary source ($i = 0$) and a non-negative variable P_{\min} that represents the minimal probability of delivering the shipment in time.

Let us note that positive decisions are modelled by the value of 1 and negative decisions by the value of 0 for all the binary variables. The mathematical model has the following form [6]:

$$\min f(x, y, P_{\min}) = \sum_{i \in I} f_i y_i + \sum_{j \in J} c_1 e_{0j} \frac{b_j}{k_1} x_{0j} + \sum_{i \in I} \sum_{j \in J} \left(c_1 d_{0i} \frac{b_j}{k_1} + c_2 d_{ij} \frac{b_j}{k_2} \right) x_{ij} \quad (1)$$

$$\max f(x, y, P_{\min}) = P_{\min} \quad (2)$$

subject to:

$$\sum_{i \in I \cup \{0\}} x_{ij} = 1 \quad \text{for } j \in J \quad (3)$$

$$\sum_{j \in J} b_j x_{ij} \leq q_i \quad \text{for } i \in I \quad (4)$$

$$p_{ij} x_{ij} \geq P_{\min} - T(1 - x_{ij}) \quad \text{for } i \in I \cup \{0\}, j \in J \quad (5)$$

$$x_{ij} \leq y_i \quad \text{for } i \in I, j \in J \quad (6)$$

$$x_{ij} \in \{0;1\} \quad \text{for } i \in I \cup \{0\}, j \in J \quad (7)$$

$$y_i \in \{0;1\} \quad \text{for } i \in I, j \in J \quad (8)$$

$$P_{\min} \geq 0 \quad (9)$$

Functions (1) and (2) represent the optimization criteria – the running costs of the whole distribution system per year (1) and the minimal value of the probability that the shipment is delivered in time (2). The group of constraints (3) ensures that each customer is supplied either from the primary source or from the single place. The group of constraints (4) assures that the capacity of each warehouse is not exceeded. The group of constraints (5) creates logical links among the variables x_{ij} and P_{\min} . The parameter of T that is used in constraints (5) is so-called prohibitive constant. The group constraints (6) models logical links among the variables x_{ij} and y_i . Specifically, the constraints ensure that if the warehouse is not situated in the place no customer is assigned to this place. On the other hand, if a customer is supplied from the place, the warehouse must be situated in this place. The groups of constraints (7) up to (9) define domains of definition for the individual variables of the model. For the method STEM it holds that in the case of single-criterion optimization using function (1) constraints (3), (4), (6) – (8) are used, in the case of using function (2) constraints (3) up to (9) are used.

5 EXPERIMENTS

In order to test the model we chose an example with 7 possible locations for the warehouse and 17 customers. Entry data was got using a pseudorandom number generator [2], [10]; the values were suitably transformed so that the values correspond to conditions of a real distribution system.

The process of entry data preparation is published in [5]. Entry data got by the transformation of generated data is listed in Tables 1 up to 4.

Table 1: Entry data – the customers' requests [unit of goods per year]

Customer	1	2	3	4	5	6	7	8	9
Request	1 200	2 600	2 500	2 400	1 900	4 000	5 400	2 000	1 800
Customer	10	11	12	13	14	15	16	17	
Request	1 800	1 600	2 200	2 000	3 800	3 400	3 000	5 800	

Table 2: Entry data – information about the vehicles

Vehicle	Vehicle capacity [unit of goods]	Running costs [monetary unit per km]
1	100	80
2	50	50

Table 3: Warehouses – the capacity [unit of goods per year] and the running costs [thousands of monetary unit per year]

Warehouse	1	2	3	4	5	6	7
Capacity	5 049	4 150	5 828	6 150	6 417	7 776	7 134
Running costs	3 109.05	488.19	12 253.9	26 438.4	25 489.3	8 829.38	24 807.7

Table 4: Entry data – the distances among the customers and the places where the warehouse can be situated / the probabilities that the shipment is delivered in time [km/–]

C	Place 1	Place 2	Place 3	Place 4	Place 5	Place 6	Place 7	PS
1	31.5/0.99	61.1/0.83	79.9/0.94	102/0.82	73.3/0.93	82/0.81	170.2/0.96	402.8/0.86
2	174.3/0.87	182.4/0.82	52.3/0.91	64.2/0.84	141.2/0.96	109.6/0.95	47.7/0.96	219.2/0.93
3	158.8/0.99	146.7/0.89	191.1/0.89	182.7/0.82	103.6/0.83	117.9/0.99	179.2/0.86	613.9/0.89
4	19.5/0.97	103/0.88	98.3/0.95	11.1/0.89	92.4/0.86	116/0.84	143.7/0.91	404.1/0.81
5	141.6/0.97	127.3/0.84	35.1/0.97	36.9/0.96	127/0.84	122.2/0.8	84.8/0.92	479.6/0.82
6	15.1/0.85	166.8/0.99	75.1/0.9	132.9/0.96	30/0.95	32.9/0.96	187.5/0.83	273/0.85
7	75/0.81	101.6/0.88	177.6/0.84	34.9/0.82	116.7/0.87	29.3/0.82	146/0.9	241.8/0.87
8	83.3/0.86	25.3/0.93	10.8/0.8	155.9/0.82	179.1/0.91	130.6/0.92	163.6/0.92	766.9/0.84
9	118.5/0.84	150.7/0.99	86.4/0.8	97.1/0.94	143.5/0.81	21.6/0.93	22.5/0.88	525.2/0.94
10	122.2/0.97	57.4/0.93	89.9/0.92	107.6/0.8	102.5/0.95	4.3/0.83	149.8/0.93	761.3/0.91
11	63.8/0.95	143.8/0.98	11.8/0.82	160/0.91	43.8/0.86	171.5/0.93	110.8/0.91	718/0.94

12	39.8/0.99	124.6/0.8	59.2/0.97	168.6/0.93	195.2/0.94	112.4/0.94	71.4/0.85	578/0.97
13	96.5/0.81	5.5/0.99	106.6/0.91	146.1/0.85	8.9/0.93	103.3/0.92	45.2/0.83	876/0.96
14	102.6/0.95	91.4/0.98	125.8/0.89	123.2/0.83	108.4/0.91	190.6/0.83	58.3/0.81	350.2/0.91
15	76.1/0.88	105/0.87	167/0.83	140/0.8	28.1/0.8	36.5/0.94	162.7/0.89	595.1/0.94
16	24.5/0.8	184.8/0.82	112.2/0.91	146.8/0.98	68.8/0.99	122.2/0.98	178.1/0.93	902.4/0.85
17	177.7/0.85	72.2/0.83	25/0.89	3.6/0.98	55.5/0.85	80.2/0.87	109.5/0.91	303/0.97
PS	987/0.82	390.5/0.98	313.8/0.91	332.6/0.89	794.9/0.83	365.7/0.96	697/0.97	XXX

C – the customer, PS – the primary source

5.1 Achieved results

The results that were achieved by individual methods are summarized in Table 5. The rows of the table labelled by numbers 1 – 17 correspond to the customers, the results of the individual optimization experiments are listed in the columns. The values I – XII denote the experiments. The columns labelled I – IV contain the results achieved by the method based on sequential optimization according to the individual criteria. The columns labelled by V – VII correspond to the results of the STEM method and the columns VIII – XII show the results of the method based on the cumulated criterion.

In the case of the experiments with the cumulated criterion we changed the weights of the individual criteria (their ratios). The ratios are shown in the form XX/XX. The number before the slash represents the weight of the criterion modelling the running costs and the number after the slash the weight of the reliability criterion (the minimal probability that the shipment will be delivered in time). The numbers in the individual columns correspond to the number of the place from which the customer is supplied. If the number is equal to 0 then the customer is supplied from the primary source.

Let us characterize the individual experiments:

- I – the total costs of the shipment distribution were minimized.
- II – the minimal probability that the shipment will be delivered in time was maximized under the condition that the total costs do not exceed the result of experiment I.
- III – the minimal probability that the shipment will be delivered in time was maximized.
- IV – the total costs of the shipment distribution were minimized under the condition that the minimal probability does not exceed the results of experiment III.
- V – the total costs of the shipment distribution were minimized.
- VI – the minimal probability that the shipment will be delivered in time was maximized.
- VII – minimization of the maximal deviation among the compromise solution and the values of partial optimal solutions.
- VIII – minimization of the cumulated criterion value for the ratio of the weights 1/0 (a test experiment number 1).
- IX – minimization of the cumulated criterion value for the ratio of the weights 0/1 (a test experiment number 2).
- X – minimization of the cumulated criterion value for the ratio of the weights 0.7/0.3.
- XI – minimization of the cumulated criterion value for the ratio of the weights 0.5/0.5.
- XII – minimization of the cumulated criterion value for the ratio of the weights 0.3/0.7.

How to supply the customers according to the results of the individual experiments listed above you can see in Table 5. The quality of the achieved solutions is characterized by the values of both optimization criteria – see Table 6. The total costs of the shipment distribution are listed in thousands of monetary unit per time. If we use the method based on the cumulated criterion, we must take into account that the values of the objective criterion cannot be directly used

because the value of the cumulated criterion is a sum of the heterogeneous quantities that are multiplied by their weights. The values of the individual optimization criteria we must calculate from the cumulated criterion value.

The progress of the optimization calculation is shown in detail in Figures 1 – 8, the figure we got from the optimization software Xpress-IVE. In the figures we can see calculation times (the x-axis of the graphs). Because the results of the experiments I and V are the same, the graphs corresponding to these experiments are the same; therefore only one figure shows the progress of these experiments – see Figure 1. The same holds also for experiments III, VI and IX; the progress is depicted in Figure 3 for all of them. Figure 2 depicts the progress of the optimization calculation for experiment II and Figure 4 for experiment IV. Figure 5 shows the progress of the optimization calculation for experiment VII – we can see that the achieved value of the optimization criterion (the deviation) was equal to 0.09. Figure 6 depicts the progress of the optimization calculation for experiment VIII for which we applied the weights of the individual criteria in the ratio of 1/0, Figure 7 depicts the progress of the optimization calculation for experiment IX for which we applied the weights of the individual criteria in the ratio of 0/1. Figure 8 depicts the progress of the optimization calculation for experiment X for which we applied the weights of the individual criteria in the ratio of 0.7/0.3. Figure 9 shows the progress of the optimization calculation for experiment XI for which we applied the weights of the individual criteria in the ratio of 0.5/0.5. Figure 10 shows the progress of the optimization calculation for experiment XII with the weights of the individual criteria in the ratio of 0.3/0.7. Figures 1 – 10 are taken from the software Xpress-IVE [13]. The experiments we carried out were realized on a personal computer with the following configuration – processor Intel® Core™ i5-2410M CPU and 4 GB of RAM.

Table 5: Supplying the customers

Customer	The method based on sequential optimization				The STEM method			The method based on the cumulated criterion				
	I	II	III	IV	V	VI	VII	VIII	IX	X	XI	XII
1	0	0	3	7	0	3	0	0	3	0	0	0
2	0	0	0	0	0	0	0	0	0	0	0	0
3	0	0	6	6	0	6	0	0	6	0	0	0
4	0	0	1	1	0	1	0	0	1	0	0	0
5	0	0	3	1	0	3	0	0	3	0	0	0
6	0	0	2	2	0	2	0	0	2	0	0	0
7	0	0	7	7	0	7	0	0	7	0	0	0
8	2	2	6	6	2	6	2	2	6	2	2	2
9	0	0	0	0	0	0	0	0	0	0	0	0
10	0	0	0	0	0	0	0	0	0	0	0	0
11	0	0	0	0	0	0	0	0	0	0	0	0
12	0	0	0	0	0	0	0	0	0	0	0	0
13	2	2	0	0	2	0	2	2	0	2	2	2
14	0	0	0	0	0	0	0	0	0	0	0	0
15	0	0	0	0	0	0	0	0	0	0	0	0
16	0	0	5	6	0	5	0	0	5	0	0	0
17	0	0	0	0	0	0	0	0	0	0	0	0

Table 6: The values of the optimization criteria

The experiment number	The total costs of the shipment distribution [thousands of monetary unit per year]	The minimal probability that the shipment will be delivered in time [-]	The experiment number	The total costs of the shipment distribution [thousands of monetary unit per year]	The minimal probability that the shipment will be delivered in time [-]
I	21 282.0	–	VII	21 282.0	0.81
II	21 282.0	0.81	VIII	21 282.0	–
III	–	0.90	IX	–	0.90
IV	62 882.2	0.90	X	21 282.0	0.81
V	21 282.0	–	XI	21 282.0	0.81
VI	–	0.90	XII	21 282.0	0.81

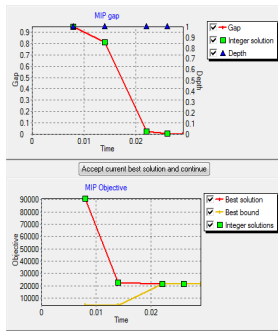

Figure 1

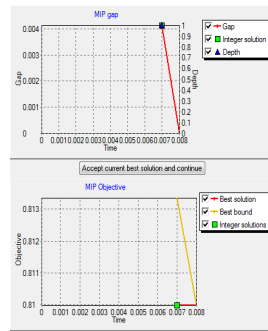

Figure 2

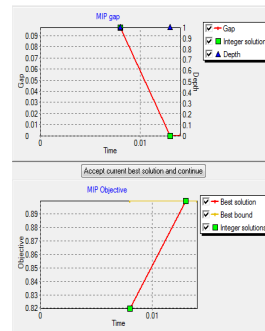

Figure 3

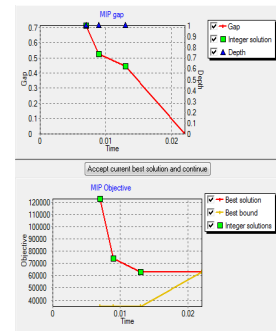

Figure 4

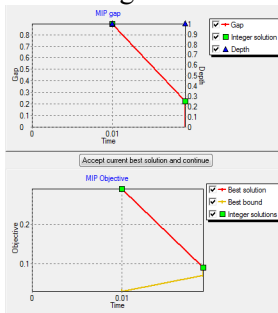

Figure 5

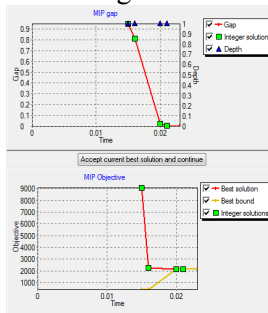

Figure 6

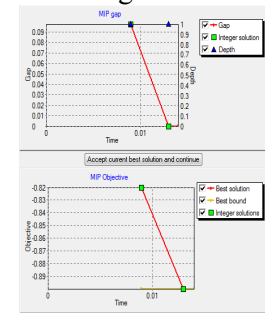

Figure 7

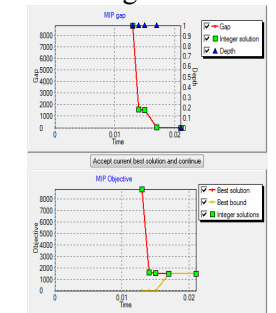

Figure 8

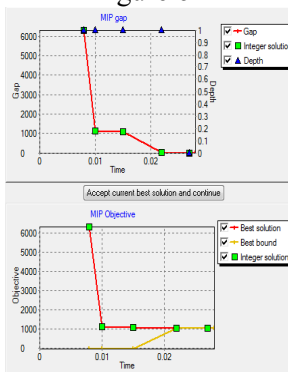

Figure 9

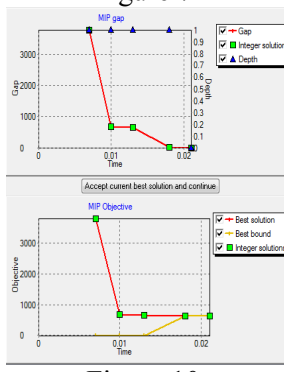

Figure 10

6 CONCLUSIONS

On the basis of the results that are summarized in Table 6 we can say the results got by the individual methods do not essentially differ in our case. Most often we can see that on the basis of the constructed mathematical model and the chosen methods of solving, the structure of the distribution system was designed so that the total running costs are equal to 21 282 thousands of monetary unit per year and the minimal probability the shipment will be delivered in time is 0.81. This structure corresponds to the results we achieved thanks to the method of sequential optimization according to the individual criteria. More concretely, it was the case where the running costs were minimized at first and then we maximized the probability that the shipment will be delivered in time under the condition of the minimal running costs. But generally we can say that differences result from particularities of the individual methods. It is necessary to consider possibilities of a contracting authority if we want to suggest the most suitable method to solve the task. If the contracting authority is able to define the priority of each criterion (that means the contracting authority can choose the most important criterion) and the other criteria should be also taken into consideration but are not so important we can utilize the method based on sequential optimization according to the individual criterions. The main advantage of the method is its simple principle. Now, let us consider a situation that the contracting authority cannot define the order of the optimization criteria but is at least able to assess advantageousness of the proposed solution. In this case we can use the STEM method which is more complicated. On the basis of the experiments we carried out we can say that the riskiest approach to

optimization of the distribution system structure is the method using the cumulated criterion. In our future work, we would like to focus on sensitivity of the solution to changes of the individual criterion weights.

Acknowledgements: This paper was supported with the internal research project SP2013/55 “Research in conventional and nonconventional modelling and optimization approaches to increase effectiveness of transport and logistics service systems”.

References

- [1] Černá, A. and Černý, J. (2004) *Teorie řízení a rozhodování v dopravních systémech*, Institut Jana Pernera Praha.
- [2] Dupač, V. and Hájek, J. (1962) *Pravděpodobnost ve vědě a technice*, Nakladatelství ČSAV, Praha,.
- [3] Fiala, P. (2006) *Modely a metody rozhodování*, VŠE v Praze, Praha, 2006.
- [4] Huang, L., Wang, W. and Wang, M. (2013) ‘Simulation Research of Space-Time Evolution of Emergency Logistics Network Reliability Based on Complex Network Theory’, *Mathematical problems in Engineering* Article ID 303187, <http://dx.doi.org/10.1155/2013/303187>.
- [5] Ivan, M. (2014) *Multikriteriální optimalizace při návrhu struktury distribučních systémů*, Dissertation Thesis. VŠB - Technical University of Ostrava, 2014.
- [6] Ivan, M. and Grosso, A. (2012) ‘Double-criterion Optimization of Distributive System Structure’, *Quantitative Methods in Economics: Multiple Criteria Decision Making XIV – Conference Proceedings*, The Slovak Society for Operations Research Conference, Bratislava, pp. 85 – 91.
- [7] Janáček, J., Janáčková, M., Szendreyová, A., Gábrišová, L., Koháni, M. and Jánošíková, L. (2010) *Navrhovanie územne rozľahlých obslužných systémov*, ŽU v Žilíně, Žilina, 2010.
- [8] Manzini, R. and Bindi, F. (2009) ‘Multi-level supply chain network design with routing’. *Transportation Research Part E – Logistics and transportation Review*, vol. 6, pp. 915 – 936.
- [9] Schulte, Ch. (1994) *Logistika*, Victoria Publishing, Praha, 1994.
- [10] Škrášek, J. and Tichý, Z. (1990) *Základy aplikované matematiky III*, SNTL, Praha, 1990.
- [11] Wang, N., Lu, J. Ch. and Kvam, P. *Multi-scale Spatial Modeling for Logistic System Reliability*, Georgia Institute of Technology.
- [12] Wu, L.; Tan, Q., Zhang, Y. (2013) ‘Delivery Time Reliability Model of Logistics Network’. *Mathematical problems in Engineering* Article ID 879472 <http://dx.doi.org/10.1155/2013/879472>
- [13] www.fico.com

Author’s address

Ing. Dušan Teichmann, Ph.D.

VŠB – Technical University of Ostrava, Faculty of Mechanical Engineering, Institute of Transport, 17. listopadu 15/2172, 708 33 Ostrava-Poruba, The Czech Republic
email: dusan.teichmann@vsb.cz

Ing. Michal Dorda, Ph.D.

VŠB – Technical University of Ostrava, Faculty of Mechanical Engineering, Institute of Transport, 17. listopadu 15/2172, 708 33 Ostrava-Poruba, The Czech Republic
email: michal.dorda@vsb.cz

Ing. Martin Ivan

VŠB – Technical University of Ostrava, Faculty of Mechanical Engineering, Institute of Transport, 17. listopadu 15/2172, 708 33 Ostrava-Poruba, The Czech Republic
email: martin.ivan@renomia.cz

NONCOOPERATIVE MULTICRITERIA GAMES

*Michaela Tichá,
University of Economics, Prague*

Abstract

The aim of this study is to investigate existence of equilibria in noncooperative multicriteria games. Multicriteria game is the special branch of the game theory if the payoff function of at least one player is a vector and the player wants to maximize all the criteria at the same time. The theory of searching equilibria is still in development, so to find all equilibria in a general multicriteria game is an unsolved problem. A new concept of solution is introduced in this study. It focuses on looking for equilibria in pure strategies. Searching according to best replies of single player is used. It is possible to find the subset of equilibria in pure strategies pretty fast and easily. The results are also clear for interpretation and they can be used for real cases.

Keywords: multicriteria games, game theory, vector payoffs, noncooperative games

JEL Classification: C72

AMS Classification: 91A10

1 INTRODUCTION

The game theory deals with the decision making if there are two or more players and each of them wants to maximize his profit. Usually, the players have one payoff but there are situations where one or more players need to maximize more than one criterion. Sometimes we can easily summarize the payoffs (for example a company sells two products and wants to maximize the profit, so we can count up the profit from each product). But it is often not possible. That is the reason why the theory of multicriteria optimization was apply into the game theory and a new theory – multicriteria games – was created. This theory deals with searching efficient equilibria in cases when at least one player has more than one payoff function. These games are often called games with vector payoffs.

The theory of multicriteria games is still in development. The algorithm that finds all equilibria in general multicriteria game is not yet known. But there exist some concepts that find a subset of equilibria or all equilibria in a specific game.

An algorithm that finds all equilibria in pure strategies is introduced in this article. We focus also on the utility theory in multicriteria game.

2 PRELIMINARIES

The first we introduce the formulation of the multicriteria game of more players. Then, we need to formulate the inequalities of vectors. Finally, we specify the equilibria. We use the definitions from (Tichá, 2012).

Definition 1.

Let $n \in \mathbb{N}$ and $N = \{1, 2, \dots, n\}$ is a set of n players, X_i is the set of pure strategies of the player $i \in N$ and for every player $i \in N$ we have the vector payoffs

$$u_i : \prod_{j \in N} X_j \rightarrow R^{r(i)},$$

that assigns every combination of strategies of players point $r(i)$ -dimensional Euclid space where $r(i)$ is the number of criteria of player $i \in N$. We denote by

$$G = \langle N, (X_i)_{i \in N}, (u_i)_{i \in N} \rangle$$

the multicriteria game.

Analogically we extend to mixed strategies. Let denote by $\Delta(X_i)$ the set of mixed strategies of player $i \in N$. Then for mixed strategy $x_i \in \Delta(X_i)$ we denote by x_{ij} the probability that player i answer by the pure strategy j .

Definition 2.

Let $G = \langle N, (X_i)_{i \in N}, (u_i)_{i \in N} \rangle$ is the multicriteria game from the Definition 1. Now let consider the sets of mixed strategies $\Delta(X_i)$ by the set $(X_i)_{i \in N}$. Now we call the game G *mixed extension of the multicriteria game*.

We consider only the mixed extension of the multicriteria game in the following text.

Further we need to compare vectors.

Definition 3.

Let $a, b \in R^m$. Then

$$\begin{aligned} a > b & \quad \text{if } a_j \geq b_j \text{ for every } j \in \{1, \dots, m\}, \\ a \geq b & \quad \text{if } a > b \text{ and } a \neq b, \\ a > b & \quad \text{if } a_j > b_j \text{ for every } j \in \{1, \dots, m\}. \end{aligned}$$

We say a *dominates* b , if $a > b$.

Finally we define the equilibrium of multicriteria games. Let denote x_{-i} the set of strategies of all players except for player i : $x_{-i} = (x_1, \dots, x_{i-1}, x_{i+1}, \dots, x_n)$ according to customs.

In classical one-criterion game the Nash equilibrium is the strategic profile $x \in \prod_{i \in N} \Delta(X_i)$, if any

player does not have alternative strategy $y_j \in \Delta(X_j)$ so that his payoff is higher (provided that other players realize the same strategy), it is $u_j(y_j, x_{-j}) > u_j(x)$. There exists the same definition in multicriteria game. The payoffs are vector functions but we are able to compare them according to Definition 3. We use two definitions – the strong equilibrium and the weak equilibrium.

Definition 4.

We say that a multistrategy $x \in \prod_{i \in N} \Delta(X_i)$ is *weak equilibrium*, if for any player $i \in N$ there does not exist strategy $\tilde{x}_i \in \Delta(X_i)$ satisfying $u_i(\tilde{x}_i, x_{-i}) > u_i(x_i, x_{-i})$.

Definition 5.

We say that a multistrategy $x \in \prod_{i \in N} \Delta(X_i)$ is *strong equilibrium*, if for any player $i \in N$ there does not exist strategy $\tilde{x}_i \in \Delta(X_i)$ satisfying $u_i(\tilde{x}_i, x_{-i}) \geq u_i(x_i, x_{-i})$.

Strong equilibrium is analogical to efficient point in multicriteria optimization. It is much better equilibrium for the player because it means that there does not exist a strategy which enable at least one higher value and other the same. It is a natural definition. Unfortunately, searching the strong equilibrium is usually more difficult. That is the reason why the Definition 4 is often used. The weak equilibrium says that there does not exist an alternative strategy that player gets better in all criteria at the same time.

Now we introduce the definition of the best response and then equivalent definition of equilibria.

Definition 6.

Let $x_{-i} \in \Delta(X_{-i})$ is a strategy profile of all player except for player i . The strategy $x_i \in \Delta(X_i)$ of the player i is called *best response of the player i against x_{-i}* , if there does not exist strategy $\tilde{x}_i \in \Delta(X_i)$ so that $u_i(\tilde{x}_i, x_{-i}) > u_i(x_i, x_{-i})$.

Definition 7.

The strategy $x \in \prod_{i \in N} \Delta(X_i)$ is *weak equilibrium* if for each player i is his strategy best response of the player i against the strategies of other players.

If we use \geq in Definition 6 then Definition 7 means the strong equilibrium.

We are not able to find all equilibria. Let show the concept scalarization of the multicriteria game.

2.1 Scalarization of the multicriteria game

It is easy to use weights and to reduce the multicriteria game to classical one-criterion game and to solve it according to known methods.

Definition 8.

Let $n \in \mathbb{N}$ and $N = \{1, 2, \dots, n\}$ is a set of n players, X_i is the set of pure strategies of the player $i \in N$ and for every player $i \in N$ we have the vector payoffs $u^i : \prod_{j \in N} X_j \rightarrow R^{r(i)}$.

Let $\lambda = (\lambda^1, \lambda^2, \dots, \lambda^n)$ are the weights of player $1, 2, \dots, n$, it is $\left\{ \lambda^i \in R^{r(i)} : \lambda_j^i \geq 0, \sum_{j=1}^{r(i)} \lambda_j^i = 1 \right\}$.

We denote by

$$G^\lambda = \left\langle N, (X_i)_{i \in N}, \left(\sum_{j=1}^{r(i)} \lambda_j^i u_j^i \right)_{i \in N} \right\rangle$$

the scalarization of the multicriteria game $G = \langle N, (X_i)_{i \in N}, (u_i)_{i \in N} \rangle$.

Theorem 1.

Suppose that x is a Nash equilibrium of a classical game $G^\lambda = \left\langle N, (X_i)_{i \in N}, \left(\sum_{j=1}^{r(i)} \lambda_j^i u_j^i \right)_{i \in N} \right\rangle$. Then

x is also weak equilibrium in the multicriteria game $G = \langle N, (X_i)_{i \in N}, (u_i)_{i \in N} \rangle$.

This theorem is proved in (Krus, Bronisz, 1994).

3 UTILITY THEORY

In the scalarization of the multicriteria game we consider only the linear combination of the criteria. We can generalize this theorem. Let assume each player has a utility function that is strongly increasing. Then we can define the utilization of the multicriteria game.

Definition 9.

Let $n \in \mathbb{N}$ and $N = \{1, 2, \dots, n\}$ is a set of n players, X_i is the set of pure strategies of the player $i \in N$ and for every player $i \in N$ we have the vector payoffs $u^i : \prod_{j \in N} X_j \rightarrow R^{r(i)}$.

Let have the function $f = (f_1, f_2, \dots, f_n)$, where $f_i(u^i) : R^{r(i)} \rightarrow R$ are strongly increasing.

We denote by

$$G^f = \left\langle N, (X_i)_{i \in N}, (f_i(u^i))_{i \in N} \right\rangle$$

the utilization of the multicriteria game $G = \langle N, (X_i)_{i \in N}, (u_i)_{i \in N} \rangle$.

Now we can prove the theorem.

Theorem 2.

Suppose that x is a Nash equilibrium of a classical game $\{X(N), G^f\}$ where $X(N)$ is the set of strategies of N players. Then x is also weak equilibrium in the multicriteria game $\{X(N), G\}$.

Proof.

Let assume $x \in \Delta(X)$ is a Nash equilibrium. Then for all strategies $y \in \Delta(X)$ so that $y = (y_i; x_{-i})$ is

$$f_i(u^i(x)) \geq f_i(u^i(y)).$$

Now suppose that x is not weak equilibrium of the multicriteria game. Then there exists player i and strategy $y \in \Delta(X)$, $y = (y_i; x_{-i})$ so that

$$u^i(x) < u^i(y)$$

in the sense vector inequalities from Definition 3.

But then, if f_i is strongly increasing, is

$$f_i(u^i(x)) < f_i(u^i(y)).$$

That is contradiction because we assume that x is Nash equilibrium.

4 EQUILIBRIUM IN PURE STRATEGIES

The equilibria in pure strategies are usually rare in classical games. They exist only in special cases. The situation in multicriteria games is rather different. The solution in pure strategies exists very often. The probability of the existence of such equilibrium is increasing with the number of criteria.

We show how we can easily find the equilibria in pure strategies. We use only linear programming. The idea is in Definition 7. We control every point in pure strategies and verify if it is equilibrium or not. The point is equilibrium if each player realizes his best response to strategic profiles of other players.

Without loss of generality let assume matrix game of two players. The first player has m pure strategies and r criteria. The second player has n pure strategies and s criteria. The game is determined by following matrices:

$$A^i = \begin{pmatrix} a_{11}^i & a_{12}^i & a_{13}^i & \dots & a_{1n}^i \\ a_{21}^i & a_{22}^i & a_{23}^i & \dots & a_{2n}^i \\ a_{31}^i & a_{32}^i & a_{33}^i & \dots & a_{3n}^i \\ \vdots & \vdots & \vdots & \ddots & \vdots \\ a_{m1}^i & a_{m2}^i & a_{m3}^i & \dots & a_{mn}^i \end{pmatrix}, i = 1, \dots, r$$

$$B^j = \begin{pmatrix} b_{11}^j & b_{12}^j & b_{13}^j & \dots & b_{1n}^j \\ b_{21}^j & b_{22}^j & b_{23}^j & \dots & b_{2n}^j \\ b_{31}^j & b_{32}^j & b_{33}^j & \dots & b_{3n}^j \\ \vdots & \vdots & \vdots & \ddots & \vdots \\ b_{m1}^j & b_{m2}^j & b_{m3}^j & \dots & b_{mn}^j \end{pmatrix}, j = 1, \dots, s$$

Let use full search. For every strategy k of the first player and strategy l of the second player we solve two linear programs. In the first program we find out if the pure strategy k is the best response of the first player. In the second program we find out if the pure strategy l is the best response of the second player.

(LP1)

$\max v_1$

$$v_1 a_{1l}^i + v_2 a_{2l}^i + \dots + v_{k-1} a_{k-1,l}^i + v_{k+1} a_{k+1,l}^i + \dots + v_m a_{ml}^i \geq a_{kl}^i, i = 1 \dots r$$

$$\sum_{h=1}^{k-1} v_h + \sum_{h=k+1}^m v_h = 1$$

$$v_h \geq 0, h = 1, \dots, k-1, k+1, \dots, m$$

(LP2)

$\max w_1$

$$w_1 b_{k1}^j + w_2 b_{k2}^j + \dots + w_{l-1} b_{k,l-1}^j + w_{l+1} b_{k,l+1}^j + \dots + w_n b_{kn}^j \geq b_{kl}^j, j = 1 \dots s$$

$$\sum_{h=1}^{l-1} w_h + \sum_{h=l+1}^n w_h = 1$$

$$w_h \geq 0, h = 1, \dots, l-1, l+1, \dots, n$$

The objective function is only for the formality. The point is if the programs find a solution. If there exists such a point $(v_1, v_2 + \dots + v_{k-1}, v_{k+1}, \dots, v_m)$, resp. $(w_1, w_2 + \dots + w_{k-1}, w_{k+1}, \dots, w_m)$ then the pure strategy k , resp. l is not the best response to the pure strategy l , resp. k and the point (k, l) is not equilibrium. If there does not exist any of such points, then it is proved that (k, l) is equilibrium.

We verify this for every pair of pure strategies. We have to solve $2mn$ linear programs. We get all the equilibria in pure strategies.

5 CONCLUSIONS

We introduced generalization of the scalarization of the multicriteria games to general strongly increasing utility function and the algorithm for searching equilibria in pure strategies. The algorithm needs solving of $2mn$ linear programs, where m is the number of pure strategies of the first player and n is the number of pure strategies of the second player. In case of three players it is $2mno$ where o is the number of pure strategies of the third player etc. Solution in pure strategies is quite important because there usually exist gigantic amount of solutions and it is not transparent. It can be also easily used in reality.

Acknowledgements: This work was supported by IGA VŠE, project no. F4/19/2013.

References

- [1] Krus, L. and Bronisz, P. (1994) 'On n-person noncooperative multicriteria games described in strategic form', *Annals of Operations Research* vol. 51, pp. 83-97.
- [2] Tichá, M. (2012) *Vícekritériální hry*, [Diploma thesis] Prague: MFF UK.

Author's address

RNDr. Ing. Michaela Tichá

University of Economics, Prague, Faculty of informatics and statistics, Department of Operations research and Econometrics

W. Churchill Sq. 4, 130 67 Prague

Czech Republic

email: xticm11@vse.cz

NONLINEAR DSGE MODEL OF SLOVAK ECONOMY WITH TIME-VARYING PARAMETERS

Stanislav Tvrz, Osvald Vašíček
Masaryk University, Brno

Abstract

In this paper, we study the dramatic changes in the structure and behaviour of the Slovak economy in a period of the accession to the euro area and the Great recession and subsequent return to the long-run growth equilibrium. This small and very open economy is represented by nonlinear dynamic stochastic model of a general equilibrium with financial accelerator. The development of time-varying structural parameters is identified using the second order approximation of a nonlinear DSGE model. The model is estimated with the use of nonlinear particle filter. It is our goal to identify the most important changes in behaviour and underlying structure of the Slovak economy. We also try to determine to what extent was the recent development of the Slovak economy influenced by fluctuating exogenous shocks and what was the relevance of the structural changes.

Keywords: nonlinear DSGE model, Great recession, monetary union, time-varying parameters, deep parameters, nonlinear particle filter, unscented particle filter

JEL Classification: E32, E44, E58

AMS Classification: 91B64

INTRODUCTION

Slovakia became a member of the euro area on 1 January 2009 in a period of global economic difficulties and general downturn of economic activity that is today called the Great recession. This extraordinary confluence of events that are critical to the development of this small open economy calls out for closer investigation of possible short-term and long-term changes in the structure of the Slovak economy. The aim of this paper is to identify the most important changes of the structural parameters during and after the Great recession and to interpret these changes in terms of behaviour of representative economic agents.

In this paper, we estimate a DSGE model of the Slovak small open economy with time-varying parameters. We perform a filtration of a nonlinear model with the use of unscented particle filter (UPF) to identify the unobserved trajectories of the time-varying parameters. Significant changes of parameter values are interpreted as structural changes of the economy.

1 MODEL

Since we focus on the period of financial and subsequent economic crisis, a DSGE model with financial frictions is used for the analysis. In our paper we use the model framework developed by Shaari [5] that incorporates financial accelerator mechanism proposed by Bernanke *et al.* [1] into the small open economy setting of Justiniano and Preston [4] and Galí and Monacelli [2]. This tractable medium-sized model of a small open economy incorporates important real as well as nominal rigidities and allows us to describe the Slovak economy in a reasonable detail. Structure of the model is quite standard, therefore, we will describe only the most important features of the model.

The model contains households, entrepreneurs, retailers, central bank and foreign sector. The households receive wages for supplied labour, government transfers, profits made by retailers and domestic and foreign bonds returns. Domestic bonds pay fixed nominal return in domestic currency while foreign non-contingent bonds give a risk adjusted nominal return denominated in foreign currency. The debt-elastic risk premium contains exogenous AR(1) component of risk-

premium or uncovered interest parity shock. The households then spend their earnings on consumption and domestic and foreign bonds acquisition.

1.1 Entrepreneurs

The entrepreneurs play two important roles in the model. They run wholesale goods producing firms and they produce and own the capital. Market of intermediate goods as well as capital goods market is assumed to be competitive. The wholesale goods production is affected by domestic productivity AR(1) shock and the capital goods production is subject to capital adjustment costs. Entrepreneurs finance the production and ownership of capital K_t by their net-worth N_t and borrowed funds. Cost of borrowed funds is influenced by borrower's leverage ratio via external finance premium,

$$EFP_t = \left(\frac{N_t}{Q_{t-1}K_t} \right)^{-\chi} \quad (1)$$

where Q_t is real price of capital or Tobin's Q and χ is financial accelerator parameter. To maximize profit, the entrepreneurs choose the optimal level of capital and borrowed funds.

Each period a proportion $(1 - A_t^{NW})\zeta$ of entrepreneurs leaves the market and their equity $(1 - A_t^{NW})\zeta V_t$ is transferred to households in a form of transfers. A_t^{NW} is a shock in entrepreneurial net worth. It influences the development of net worth by changing the bankruptcy rate of entrepreneurs and its positive innovations increase the survival rate of entrepreneurs. Its logarithmic deviation from steady state is assumed to evolve according to AR(1) process. ζ is the steady-state bankruptcy rate.

1.2 Retailers

Next, there are two types of retailers in the model. Home goods retailers and foreign goods retailers. Both types of retailers are assumed to operate in conditions of monopolistic competition. Home good retailers buy domestic intermediate goods at wholesale price and sell the final home goods to the consumers. Foreign good retailers buy goods from foreign producers at the wholesale price and resell the foreign goods to the domestic consumers. The difference between foreign wholesale price expressed in domestic currency and final foreign goods price, i.e. deviation from law of one price is determined by exogenous AR(1) shock. By Calvo-type price setting and inflation indexation of the retailers the nominal rigidities are introduced into the model.

1.3 Central bank

The central bank determines the nominal interest rate in accordance with following forward/backward-looking Henderson McKibbin Taylor interest rate rule

$$r_t = \rho \cdot r_{t-1} + (1 - \rho) \cdot [\beta_\pi \cdot E(\pi_{t+1}) + \theta_y \cdot y_t] + \varepsilon_t^{MP} \quad (2)$$

where r_t is nominal policy interest rate, ρ is a smoothing parameter, β_π is weight parameter of expected inflation $E(\pi_{t+1})$ and θ_y is weight parameter of output gap y_t . Deviations of interest rate from the interest rate rule are explained as monetary policy i.i.d. shocks ε_t^{MP} .

1.4 Foreign sector

The foreign economy variables - real output, CPI inflation and nominal interest rate, are modelled using a structural VAR(1) model as described in equation (3).

$$\begin{pmatrix} y_t^* \\ \pi_t^* \\ r_t^* \end{pmatrix} = \begin{pmatrix} \rho_{y^*y^*} & \rho_{y^*\pi^*} & \rho_{y^*r^*} \\ \rho_{\pi^*y^*} & \rho_{\pi^*\pi^*} & \rho_{\pi^*r^*} \\ \rho_{r^*y^*} & \rho_{r^*\pi^*} & \rho_{r^*r^*} \end{pmatrix} \begin{pmatrix} y_{t-1}^* \\ \pi_{t-1}^* \\ r_{t-1}^* \end{pmatrix} + \begin{pmatrix} 1 & 0 & 0 \\ \sigma_{\pi^*y^*} & 1 & 0 \\ \sigma_{r^*y^*} & \sigma_{r^*\pi^*} & 1 \end{pmatrix} \begin{pmatrix} \varepsilon_t^{y^*} \\ \varepsilon_t^{\pi^*} \\ \varepsilon_t^{r^*} \end{pmatrix} \quad (3)$$

1.5 Time-varying parameters

All the estimated model parameters are considered time-varying with the exception of shock autoregression parameters and standard deviations. Time-varying parameters are defined as unobserved endogenous variables with following law of motion

$$\theta_t = (1 - \alpha_t^\theta) \cdot \theta_{t-1} + \alpha_t^\theta \cdot \bar{\theta} + v_t^\theta \quad (4)$$

where θ_t is a general time-varying parameter, $\bar{\theta}$ is initial value of this parameter, α_t^θ is a time-varying adhesion parameter common for all the remaining time-varying parameters and $v_t^\theta \sim N(0, \sigma_v^\theta)$ is exogenous innovation in the value of parameter θ_t . Setting of the adhesion parameter α_t^θ influences the tendency of the time-varying parameter θ_t to return to its initial value $\bar{\theta}$. With $\alpha_t^\theta = 0$, the time-varying parameter would be defined as random walk, while with $\alpha_t^\theta = 1$, the parameter would be white noise centred around the initial value $\bar{\theta}$. For the purposes of this paper, we set the initial value of the adhesion parameter to a value of $\alpha_0^\theta = 0.25$.

2 ESTIMATION TECHNIQUE

Unscented particle filter (UPF) is used to identify the unobserved states of the DSGE model, including the time-varying parameters, in this paper. In this section we briefly describe the main principles of this nonlinear particle filter.

2.1 Unscented transformation

Since the UPF works with the unscented transformation (UT), we will first describe the principles of this transformation. UT is a method of calculating the statistics of a nonlinear transformation of a random variable. UT estimates are accurate up to the second order of Taylor expansion of the transformation function. Suppose that we have an n -dimensional random variable x with mean \bar{x} and covariance matrix P_x . To calculate the statistics of its nonlinear transformation $y = f(x)$ we have to calculate a set of sigma points and weights $\{X_i, W_i\}_{i=0}^{2n}$. To capture the mean and covariance of random variable x , the sigma points and weights have to be chosen in a following way

$$\begin{aligned} X_0 &= \bar{x}, & W_0 &= \frac{\kappa}{n+\kappa} \\ X_i &= \bar{x} + \left(\sqrt{(n+\kappa)P_x}\right)_i, & W_i &= \frac{\kappa}{2(n+\kappa)}, i = 1, \dots, n, \\ X_i &= \bar{x} - \left(\sqrt{(n+\kappa)P_x}\right)_{i-n}, & W_i &= \frac{\kappa}{2(n+\kappa)}, i = n+1, \dots, 2n, \end{aligned} \quad (5)$$

where κ is a scaling parameter and $\left(\sqrt{(n+\kappa)P_x}\right)_i$ is the i -th column of the matrix square root of $(n+\kappa)P_x$. Sum of weights W_i is equal to one. Mean and covariance matrix of y can then be described as $\bar{y} = \sum_i W_i f(X_i)$ and $P_y = \sum_i W_i (f(X_i) - \bar{y})(f(X_i) - \bar{y})^T$.

2.2 Nonlinear state-space model

In this subsection we introduce the notation used to describe the nonlinear state-space system. The state transition is described by the transition equation

$$x_t = g(\theta_{t-1}, w_{t-1}), \quad (6)$$

where $x_t \in R^{n_x}$ is the vector of unobserved states and $w_t \in R^{n_w}$ is the process noise with covariance matrix Q . Observations are related to the unobserved states by the measurement equation

$$y_t = h(x_t, v_t), \quad (7)$$

where $y_t \in R^{n_y}$ is the vector of observations and $v_t \in R^{n_y}$ is the measurement noise with covariance matrix R .

2.3 Unscented particle filter

Unlike basic Kalman filter that is optimal only for linear systems with Gaussian noise, the unscented particle filter is a more sophisticated tool that can be used even for nonlinear state-

space systems with non-Gaussian. In this section, we provide only the basic principles of the algorithm. A detailed description can be found for example in Van Der Merwe *et al.* [6] or Haug [3].

In a condensed form, the UPF algorithm can be described as follows:

- I. Initialization: $\mathbf{t} = \mathbf{0}$, set the prior mean $\bar{\mathbf{x}}_0$ and covariance matrix \mathbf{P}_0 for the state vector \mathbf{x}_t .
- II. Generating particles: Draw a total of N particles $\mathbf{x}_t^{(i)}, i = 1, \dots, N$ from distribution $p(\mathbf{x}_t)$ with mean $\bar{\mathbf{x}}_t$ and covariance matrix \mathbf{P}_t and update the mean and covariance matrix of augmented state vector $\mathbf{x}_t^a = [\mathbf{x}_t \ w_t \ v_t]^T$ ($\mathbf{x}_t^a \in \mathbb{R}^{n_a}$, $n_a = n_x + n_w + n_y$).
- III. Unscented transformation: Calculate sigma points and weights $\{X_i, W_i\}_{i=0}^{2n}$ for the random vector \mathbf{x}_t^a .
- IV. Time Update: $t = t + 1$, for each particle ($i = 1, \dots, N$) propagate the particle into future with the use of sigma points and transition and measurement equation and calculate means $\bar{\mathbf{x}}_{(t|t-1)}^{(i)}, \bar{\mathbf{y}}_{(t|t-1)}^{(i)}$ and covariance matrices $\mathbf{P}_{(t|t-1)}^{(i)}, \mathbf{P}_{(y|y)}^{(i)}, \mathbf{P}_{(x|y)}^{(i)}$.
- V. Unscented Kalman filter: For each particle ($i = 1, \dots, N$) calculate $\mathbf{K}_t^{(i)} = \mathbf{P}_{(x|y)}^{(i)} \left(\mathbf{P}_{(y|y)}^{(i)} \right)^{-1}$, $\bar{\mathbf{x}}_t^{(i)} = \bar{\mathbf{x}}_{(t|t-1)}^{(i)} + \mathbf{K}_t^{(i)} \left(\mathbf{y}_t - \bar{\mathbf{y}}_{(t|t-1)}^{(i)} \right)$ and $\mathbf{P}_t^{(i)} = \mathbf{P}_{(t|t-1)}^{(i)} - \mathbf{K}_t^{(i)} \mathbf{P}_{(y|y)}^{(i)} \left(\mathbf{K}_t^{(i)} \right)^T$.
- VI. Weights update: for each particle ($i = 1, \dots, N$) draw a sample $\mathbf{x}_t^{(i)}$ from $q\left(\mathbf{x}_t^{(i)} | \mathbf{x}_{0:t-1}, \mathbf{y}_{1:t}\right) = N\left(\bar{\mathbf{x}}_t^{(i)}, \mathbf{P}_t^{(i)}\right)$ and evaluate the importance weight $\omega_t^i \propto \frac{p(\mathbf{y}_t | \mathbf{x}_t^i) p(\mathbf{x}_t^i | \mathbf{x}_{t-1}^i)}{q(\mathbf{x}_t^i | \mathbf{x}_{0:t-1}, \mathbf{y}_{1:t})}$. For all particles together, normalize the weights and calculate $\bar{\mathbf{x}}_t = \sum_i \omega_t^{(i)} \mathbf{x}_t^{(i)}$ and $\mathbf{P}_t = \sum_i \omega_t^{(i)} \left(\mathbf{x}_t^{(i)} - \bar{\mathbf{x}}_t \right) \left(\mathbf{x}_t^{(i)} - \bar{\mathbf{x}}_t \right)^T$. Continue by step II until $t = t_{max}$.

Figure 1 contains a diagram of the UPF algorithm.

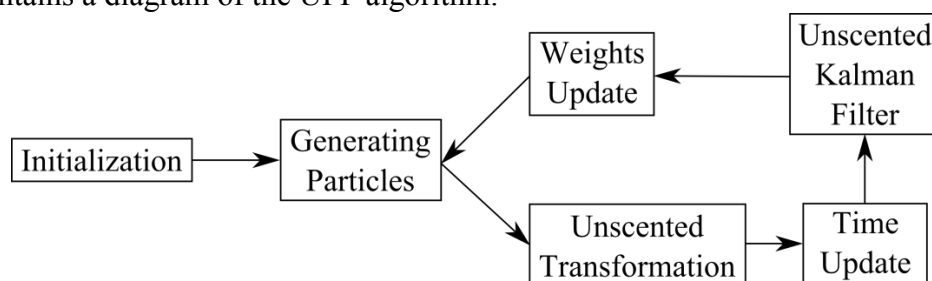

Figure 1: Unscented particle filter

In our application we performed 20 runs of the UPF with 30.000 particles each for the second order approximation of the nonlinear DSGE model.

2.4 Initial values

Before the application of the UPF algorithm we estimated the model with constant parameters to obtain estimates of autoregression parameters and standard deviations of structural shocks that are considered constant even in the UPF. Also, the posterior means of the structural parameters were used as initial values of the time-varying parameters ($\bar{\theta}$) in the UPF estimation. Standard deviations of time-varying parameter innovations (σ_v^θ) were set proportional to the standard deviations of posterior estimates of the model with constant parameters. Constant model parameters were estimated using Random Walk Metropolis-Hastings algorithm as implemented in Dynare toolbox for Matlab. Two parallel chains of 1.000.000 draws each were generated during the estimation. First 50 % of draws were discarded as burn-in sample. The scale parameter was set to achieve acceptance rate around 30 %.

3. Data

Quarterly time series of eight observables were used for the purposes of estimation. These time series cover the period between the second quarter of 1999 and the third quarter of 2013 and contain 58 observations. Time series of real gross domestic product (GDP), harmonised consumer price index (CPI), 3-month policy interest rate and real investment are used for the domestic economy. The foreign economy is represented by the 17 Euro area countries. Seasonally adjusted time series of real GDP, CPI and 3-month policy interest rate are used. Time series of SKK/EUR real exchange rate is also used. These seasonally adjusted time series were obtained from the Eurostat, National Bank of Slovakia and European Central Bank databases. The original time series were transformed prior to estimation so as to express the logarithmic deviations from their respective steady states. Logarithmic deviations of most observables from their trends were calculated with the use of Hodrick-Prescott (HP) filter.¹ Time series of the domestic and foreign CPI inflation were demeaned.

4. Empirical results

In this section we present the most interesting empirical results of the UPF estimation. Figure 2 contains the trajectories of selected time-varying parameters. Some parameters that were estimated as time-varying showed only negligible deviations from their initial values², and therefore, their trajectories are not presented. Most of the parameters of the financial sector showed significant deviations from the initial values, especially the external finance premium elasticity χ , bankruptcy rate ζ , steady state capital to net worth ratio Γ and capital adjustment costs ψ^I , which corresponds to situation during the financial crisis. Apart from the financial parameters, the foreign goods preference bias γ (openness parameter) and Taylor rule parameters also showed interesting behavior suggesting a decline in the weight of inflation and an increase of the output gap weight during 2008.

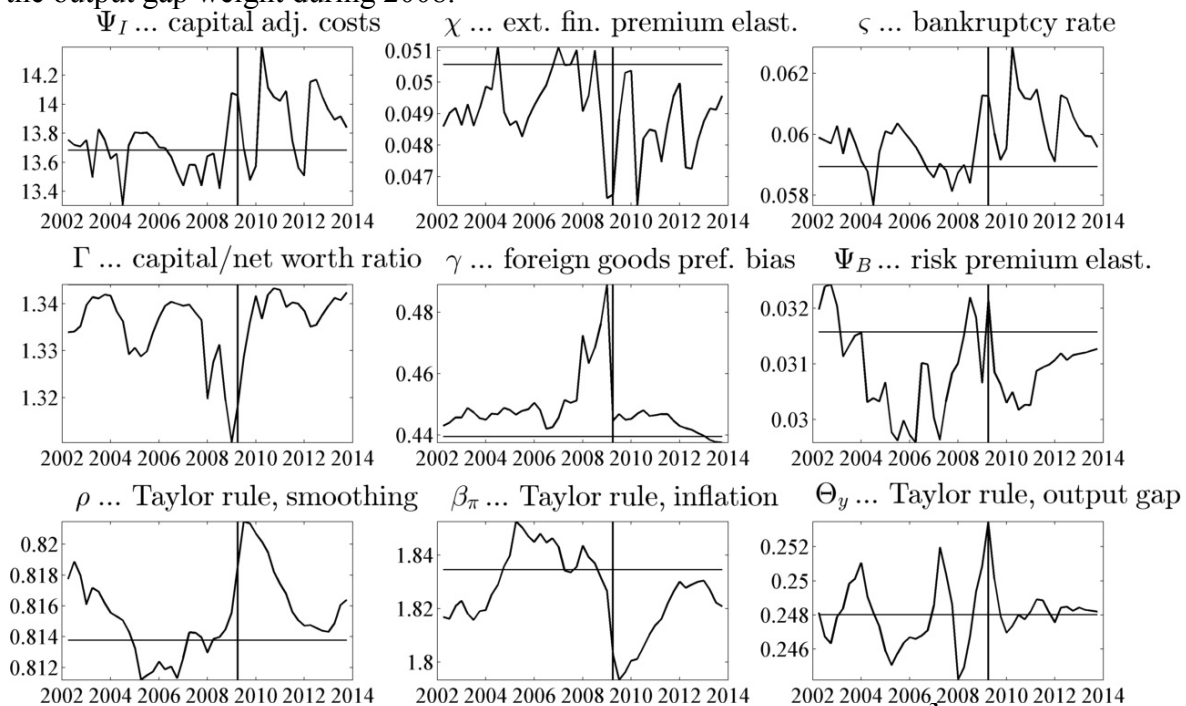

Figure 2: Selected time-varying parameter estimates³

¹ Parameter of the HP filter λ was set to 1600, a value commonly used for quarterly data.

² i.e. less than one per cent of the initial value.

³ Horizontal line represents the initial values of the time-varying parameters ($\bar{\theta}$). Vertical line marks the 1st quarter of 2009 when Slovakia joined the EMU.

CONCLUSION

In this paper, we estimated a DSGE model of a small open Slovak economy with financial accelerator. We applied a two-step approach to the estimation of the time-varying parameters. First, we estimated the models with time-invariant parameters using the Random Walk Metropolis-Hastings algorithm and then employed the obtained results for the initial setting of the second estimation technique of Unscented Particle Filter that was used for the estimation of the models with time-varying parameters. Obtained results suggest that there is a subset of structural parameters that can be considered deep. This set of parameters includes the Calvo parameters, the habit in consumption, inflation indexation and elasticity of substitution between domestic and foreign goods. The development of the financial sector parameters together with the parameter of foreign goods preference bias (openness parameter) and the parameters of the Taylor interest rate rule showed substantially more dynamic behavior, especially during the financial crisis of 2007 and the Great recession. According to the filtered trajectories of the financial parameters, the situation in the financial sector seems to be stabilized as the parameter values returned to the vicinity of their respective initial values during 2013.

Acknowledgements

This work is supported by funding of specific research at Faculty of Economics and Administration, project MUNI/A/0808/2013.

References

- [1] Bernanke, B. S., Gertler, M. and Gilchrist, S. (1999) 'The Financial Accelerator in a Quantitative Business Cycle Framework' in Taylor, J.B., and Woodford, M. (ed.) *Handbook of Macroeconomics*, vol. 1, Amsterdam: Elsevier, pp. 1341-1393.
- [2] Galí J. and Monacelli, T. (2005) 'Monetary Policy and Exchange Rate Volatility in a Small Open Economy', *Review of Economic Studies*, vol. 72, no. 3, pp. 707-734.
- [3] Haug, A. J. (2005) *A Tutorial on Bayesian Estimation and Tracking Techniques Applicable to Nonlinear and Non-Gaussian Processes*, Mitre Technical Report.
- [4] Justiniano, A. and Preston, B. (2006) 'Monetary Policy and Uncertainty in an Empirical Small Open Economy Model', *Journal of Applied Econometrics*, vol. 25, pp. 93-128.
- [5] Shaari, M. H. (2008) *Analysing Bank Negara Malaysia's Behaviour in Formulating Monetary Policy: An Empirical Approach* [Doctoral thesis], College of Business and Economics, The Australian National University.
- [6] Van Der Merwe, R., Doucet, A., De Freitas, N. and Wan, E. (2000) *The Unscented Particle Filter - CUED Technical Report 380*, Cambridge University Engineering Department.

Authors' address

Mgr. Ing. Stanislav Tvrz
 Masaryk University, Faculty of Economics and Administration, Department of Economics
 Lipová 41a, 602 00 Brno
 Czech republic
 email: tvrz@mail.muni.cz

Prof. Ing. Osvald Vašíček, CSc.
 Masaryk University, Faculty of Economics and Administration, Department of Economics
 Lipová 41a, 602 00 Brno
 Czech republic
 email: osvald@econ.muni.cz

DISCRETE STRATEGY SPACES AND PQ OLIGOPOLY EQUILIBRIA

*Jan Zouhar,
University of Economics, Prague*

Abstract

In a PQ oligopoly, firms pick both prices and quantities simultaneously. Traditional analyses of PQ oligopolies treat prices and quantities as continuous, in which case no pure-strategy equilibria exists, and mixed-strategy equilibria have some peculiar properties. In our paper we study to what extent these results hold in case prices and quantities are restricted to a discrete scale. We implement an efficient method to find equilibria with discrete strategy spaces and carry out a series of experiments with varying settings of the cost function and the price-quantity scale. Our results indicate that, in general, discretization increases the resulting profits, and the rate of convergence to the continuous case depends on the returns to scale.

Keywords: *PQ oligopoly, Nash equilibrium, discrete strategy spaces, market clearance.*

JEL Classification: D43

AMS Classification: 91B24

1 INTRODUCTION

In a PQ oligopoly, firms pick both prices and quantities simultaneously. Consequently, unlike in the canonical Bertrand and Cournot oligopolies, market clearing is not imposed. Traditional analyses of PQ oligopolies treat prices and quantities as continuous. It has been shown that, under fairly general conditions, no pure-strategy equilibrium exists in this case [1]. Gertner [2] was the first to characterize the (symmetric) mixed-strategy Nash equilibrium (NE) in a PQ duopoly model that is a direct extension to the classical models of Bertrand and Cournot. The resulting NEs have some rather surprising properties; but, as a major part of the probability mass is continuously distributed in the NE, it is not obvious whether these properties hold for the (legitimate) case where prices and quantities are restricted to a discrete scale. This paper aims to shed some light on this issue through a series of numeric experiments.

A similar study was carried out by McCulloch [6], but the current paper (i) has a slightly different goal, (ii) studies different types of PQ oligopolies, and (iii) uses different methods. Concretely, we (i) aim to assess the impact of different levels of price-quantity discretization and compare results with the continuous case, whereas McCulloch uses discretization only as a necessary provision to allow numeric analysis, (ii) allow for varying returns to scale, but on the other hand, assume symmetry, (iii) implement different algorithms to obtain equilibrium results.

2 GERTNER'S MODEL OF PQ DUOPOLY

We consider a static one-shot non-cooperative game in a duopoly with homogeneous production. The duopolists, firms 1 and 2, simultaneously pick prices and quantities, and both are trying to maximize their individual profit. In the sequel, we use i, j to denote either 1, 2 or 2, 1. Firm i 's profit is

$$\pi_i = p_i \min\{d_i, q_i\} - C_i(q_i), \quad (1)$$

where p_i, q_i are the price and production quantity picked by firm i , d_i is the quantity demanded of firm i 's production, and C_i is firm i 's cost function. Both price and production quantity are strategic variables, and we allow for mixed strategies; so, a strategy consists in specifying the joint distribution of price and quantity. Quantity demanded from the firms at given prices and quantities depends on two things: the industry demand, $D(p)$, and the *rationing scheme*.

Rationing scheme determines the way industry demand is divided among the duopolists in case the prices are not equal and/or the market does not clear. For instance, if prices differ and the low-priced firm does not supply the whole industry demand at its price, some of the consumers that were not served are likely to accept the higher price and purchase the good from the high-priced firm, thus creating *spillover* (or *residual*) demand. Gertner's model uses the so-called *proportional* (or *randomized*) rationing, where

$$d_i = \begin{cases} D(p_i) & \text{if } p_i < p_j, \\ \frac{D(p_j) - \min\{q_j, d_j\}}{D(p_j)} D(p_i) & \text{if } p_i > p_j, \\ \max\{D(p)/2, D(p) - q_j\} & \text{if } p_i = p_j = p. \end{cases} \quad (2)$$

Gertner makes several additional assumptions about the PQ duopoly. Most importantly, he restricts himself to the *symmetric* case, i.e. $C_i = C_j = C$, and his model is intrinsically *continuous*: prices and quantities are treated as continuous, both C and D are differentiable and $p D(p)$ is concave. (For a full list of assumptions, see [2].)

3 EQUILIBRIA WITH CONTINUOUS STRATEGY SPACES

Gertner's analysis is focused only on the special case of symmetric mixed-strategy NEs. He found that the NE structure differed markedly between the cases with decreasing or constant marginal cost (MC) and those with increasing MC. Below we summarize the main NE results, see [2] for more details.

With *decreasing or constant MC*, firms always produce the entire industry demand at the given price, and the price distribution is continuous, apart from the possibility of an atom (a mass point) at the price that nullifies industry demand, corresponding to a "no production" action. (Obviously, in case of no production, the price does not matter, so the fact that Gertner picked this particular price is in fact an *ad hoc* normalization.) Expected profit is zero, but this is not due to selling at average production cost, but due to the possibility of unsold production. Moreover, in the case of constant marginal cost, the symmetric NE is unique, and the support of the price distribution covers the entire interval from the marginal cost up to the zero-demand price. With *increasing MC*, the distribution of prices has an atom at the upper bound of the support, where the firm produces half the industry demand, and is atomless below this point, where the firm produces more than a half, but less than the entire industry demand (again, NE quantity is a deterministic function of the given price). Firms generally produce a positive expected profit.

4 FINDING EQUILIBRIA WITH DISCRETE STRATEGY SPACES

With discrete strategy spaces, PQ duopoly can be modelled as a bimatrix game. Several algorithms have been developed to find NEs in bimatrix games. In his recent study of PQ duopolies, McCulloch [6] used the Equivalence theorem of Mangasarian and Stone [5], who proved that the set of all NEs is equivalent to the set of all optimal solutions to a certain quadratic programming problem. Thus, optimization routines capable of handling quadratic programming problems, such as Matlab's `quadprog`, can be used to find such equilibria. However, it is usually much more efficient to use specialized algorithms that exploit the specific structure of bimatrix games. Moreover, aiming to compare our results with Gertner's, we could even focus on the special case of a symmetric NE in a symmetric game only. Note that computational efficiency plays a key role in our analysis as the size of the bimatrix representation of a PQ oligopoly can be very large; for instance, with 40 available prices and quantities (a size comparable with some experiments

shown below), each player has $40^2 = 1,600$ pure strategies, leaving us with a payoff matrix with $1,600^2 = 2,560,000$ elements.

In our numeric experiments, we implemented the Lemke-Howson algorithm (L-H) [4] in Matlab. As a starting point for our implementation, we used Katzwer's `LemkeHowson` function downloadable from Matlab File Exchange [3]. However, we changed the function substantially so as to optimize the code for the special case of symmetric Nash equilibria in a symmetric game. In fact, the logic of L-H uses the fact that a NE of a general bimatrix game with $m \times n$ payoff matrices \mathbf{A} and \mathbf{B} can be obtained by finding a symmetric NE of symmetric bimatrix game with matrices \mathbf{C}, \mathbf{C}^T of order $m + n$, where $\mathbf{C} = \begin{pmatrix} \mathbf{0} & \mathbf{A} \\ \mathbf{B}^T & \mathbf{0} \end{pmatrix}$, and then normalizing the first m elements

and last n elements of the solution to form the NE strategies in the original \mathbf{A}, \mathbf{B} game; see [7, p. 33–35] for more details. Therefore, if one wants to solve for a symmetric NE in a symmetric bimatrix game right from the start, the step that converts the \mathbf{A}, \mathbf{B} game to the \mathbf{C}, \mathbf{C}^T game can be omitted, and the size of the input to L-H is halved. Naturally, this has some bearing on the implementation of rest of the algorithm, but the description of the modifications is beyond the scope of this paper. The resulting Matlab code can be obtained from the author at e-mail request.

5 RESULTS AND DISCUSSION

In all numeric experiments, we kept the industry demand function fixed at $D(p) = 100 - 2p$, while varying cost functions and feasible price and production quantities. We considered three different cost functions: $C(q) = 80q^{2/3}$ (decreasing MC), $C(q) = 20q$ (constant MC), $C(q) = 10q + 0.25q^2$ (increasing MC). Four different scales of prices and quantities were used: we started with a very coarse one, where both prices and quantities were integer multiples of 10 (i.e. 0, 10, 20, ...), gradually making the scales finer by allowing multiples of 5 and 2, finishing with a model where all integer prices and quantities were allowed. This is clearly seen in Figure 1, where feasible prices and quantities are represented by white grid lines.

It turned out that, in most cases, the NE was not unique. Therefore, we carried out 100 runs of L-H for each combination of a cost function and a strategy space, choosing a random starting point each time. While the resulting NE strategies generally differed within a single model, they produced identical expected profits. In Figure 1 and Table 1 we present the results of the numeric experiments, with the 100 NEs averaged for each model. Note therefore that the individual plots in Figure 1 do not present a mixed-strategy, but an average of several ones; in our opinion, this provides a good insight into the NE structure in a compact form.

Table 1 reveals that, in general, discretization of the strategy space leads to an increase in profit. Thus, it no longer holds that duopolies with non-increasing MC exhibit zero expected profits. With decreasing MC, this “discretization gain” vanished once the fineness of the price-quantity scale surpassed a certain threshold. With constant or increasing MC, discretization gain seems to shrink in a continuous fashion, and remained positive in all experiments.

Naturally, the shape of the distribution of NE strategies is also affected. Under heavy discretization (top row in Figure 1), duopolies with constant and increasing MC had pure-strategy NEs, but these are rather extreme cases. As the strategy spaces become smoother, the distributions converge to those predicted by Gertner. The convergence process, however, takes on different shapes. Remember that in the continuous case, firms with non-increasing MC always produce entire industry demand at the given price. With decreasing MC, this is something that materializes even for a relatively coarse discretization scale: from the second row onwards in Figure 1, all dots (strategies with non-zero probability) are located either at the diagonal line representing industry demand, or at the horizontal axis representing the “no

production” action. With constant MC, however, many NE strategies contained points below the demand curve, albeit their probability seems to shrink towards zero at the expense of the points at or near the demand curve. Additionally, it can be noted that the upper bound of the support of the price distribution is smaller than the zero-demand point, but converges to this point as the price-quantity scale becomes finer.

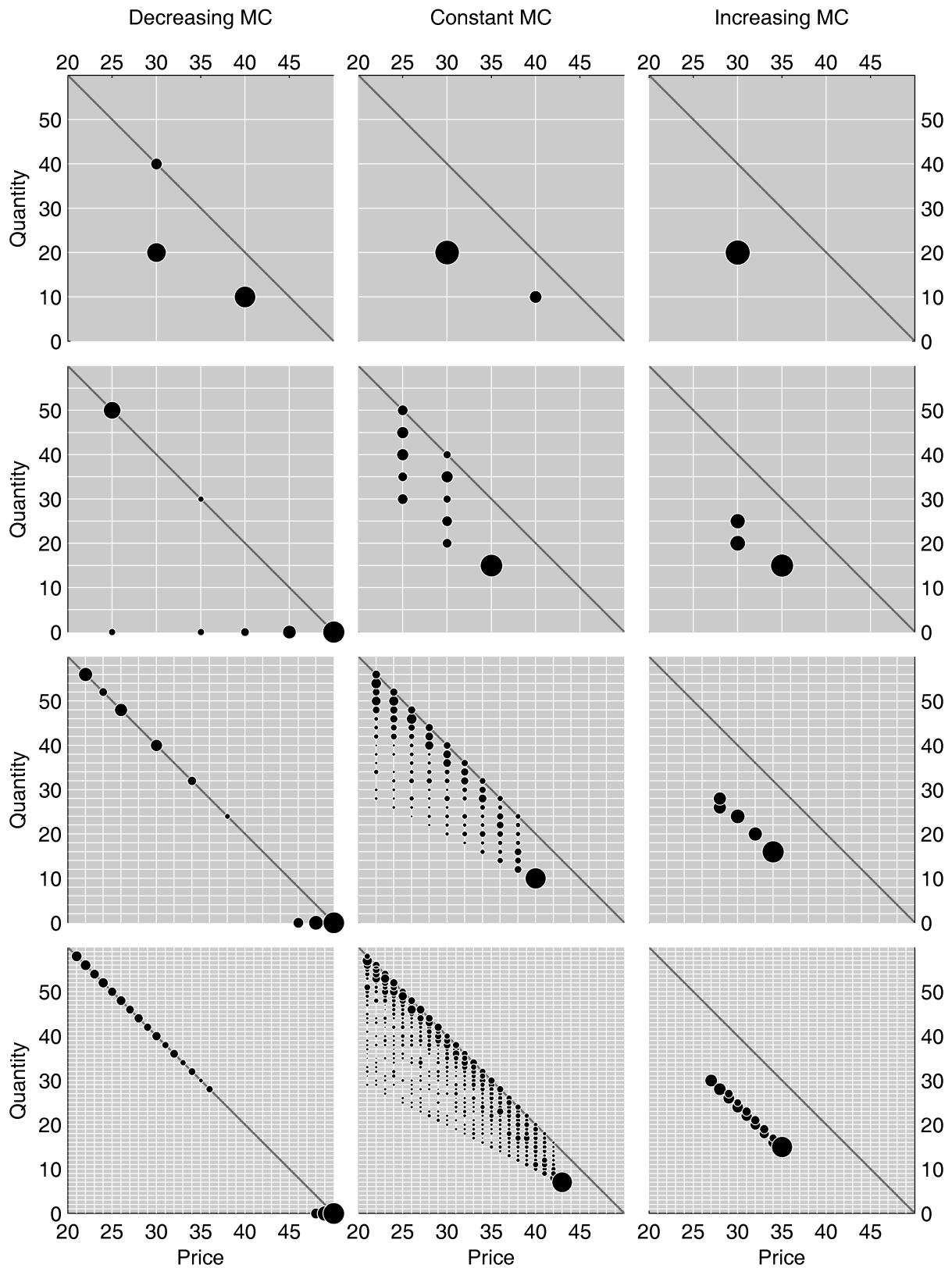

Figure 1: Symmetric NE mixed strategies under varying returns to scale (columns) and strategy spaces (rows). Each plot averages 100 NEs, dot area is proportional to probability.

Table 1: Expected profits, prices and quantities in symmetric NEs.

	p, q units	$\mathbb{E}(\pi)$	$\mathbb{E}(q)$	$\mathbb{E}(p)$	p^{\max}
Decreasing MC: $C(q) = 80q^{2/3}$	10	10.55	15.14	35.77	40
	5	0.00	13.24	42.52	48.93
	2	0.00	13.04	43.08	49.45
	1	0.00	13.02	43.28	49.72
	continuous	0			50
Constant MC: $C(q) = 20q$	10	200	19.35	30.65	30.97
	5	125	22.10	32.33	35
	2	56	23.79	34.38	40
	1	29	24.13	35.58	43
	continuous	0			50
Increasing MC: $C(q) = 10q + 0.25q^2$	10	300	20	30	30
	5	300	17.17	33.54	35
	2	281	19.13	32.35	34
	1	272.09	19.08	32.78	35
	continuous	258.62			34.91

Notes: (i) For all discrete-strategy models, averaged results from 100 NEs are presented. (ii) p^{\max} is the highest price played with non-zero probability; in continuous models with non-increasing MC, it is the lowest price that nullifies industry demand. (iii) Results for the continuous model with increasing MC are the numeric solutions reported by Gertner [2].

With increasing MC, discretization seems to make the least impact. Unlike in the remaining two models, there is no systematic movement in the expected prices and quantities or the maximum price as discretization gets finer; NE properties under severe discretization are similar as those in the continuous model – except for the difference in expected profit.

6 CONCLUSIONS

Given the experimental nature of our research, a generalization of the results beyond the studied case may be questionable. It seems natural that a more thorough sensitivity analysis should follow, assessing the impact of different model specification, which can go beyond changing the parameters of the cost and demand functions. Some of the possible directions include: (i) *different rationing rules*: throughout our experiments, we used proportional rationing, as studied by Gertner [2]; other rationing rules have been proposed in the literature, see e.g. [8,9], (ii) *non-symmetric PQ duopolies*: even though there is a lack of theory for the continuous model, it might be interesting to see whether the effect of discretization differs for asymmetric games, (iii) *n-firm PQ oligopolies*: again, it is possible that the discretization effect will be either mitigated or amplified by the presence of more than two firms. Hopefully, these alternative scenarios will be addressed in future research.

Acknowledgements: This work was supported by the Grant Agency of the Czech Republic, project no. P402/12/P241.

References

- [1] Friedman, J. W. (1988) 'On the strategic importance of prices versus quantities', *RAND Journal of Economics*, vol. 19, no. 4, pp. 607–622.

- [2] Gertner R. (1986) *Essays in Theoretical Industrial Organization*. Ph.D. thesis, Massachusetts Institute of Technology, <http://dspace.mit.edu/handle/1721.1/14892>
- [3] Katzwer, R. (2013) 'A function for computing mixed Nash equilibria in bimatrix games', *MATLAB Central File Exchange*, www.mathworks.com/matlabcentral/fileexchange/44279-lemkehowson-m.
- [4] Lemke, C. E. and Howson, J. T. (1964) 'Equilibrium points of bimatrix games', *Journal of the Society for Industrial & Applied Mathematics*, vol. 12, no. 2, pp. 413–423.
- [5] Mangasarian, O. L. and Stone, H. (1964) 'Two-person nonzero-sum games and quadratic programming', *Journal of Mathematical Analysis and Applications*, vol. 9, no. 3, pp. 348–355.
- [6] McCulloch H. (2011) 'PQ-Nash duopoly: A computational characterization. Submitted', <http://www.econ.ohio-state.edu/jhm/papers/PQNash.pdf>.
- [7] Nisan, N., Roughgarden, T., Tardos, E. and Vazirani, V. V. (2007) *Algorithmic Game Theory*. Cambridge University Press.
- [8] Tirole, J. (1988) *The theory of industrial organization*, MIT Press.
- [9] Zouhar, J. (2013) 'A note on proportional rationing in a PQ duopoly', *Mathematical Methods in Economics 2013 – Conference Proceedings*, The Czech Society for Operations Research Conference, Jihlava, pp. 1063–1068.

Author's address

Ing. Jan Zouhar, Ph.D.

Univ. of Economics, Prague, Faculty of Informatics and Statistics, Dept. of Econometrics
nám. W. Churchilla 4, 130 67 Prague 3

Czech Republic

email: honza.zouhar@gmail.com